



Safety Equipment

Catalogue valid as of January 1, 2016





Wireless Inspection Camera

- For visual inspection and documentation of electrical installations
 - Flexible operating head for difficult-to-access installations
 - Wireless WiFi camera operation via smartphone/tablet
 - No downtimes due to disconnection of the installation
- Page 18

Earthing and Short-Circuiting Devices for Railway Applications with Aluminium Cable



- For earthing and short-circuiting electrical installations at the work location
 - Weight-reduced
 - Lower risk of theft compared to copper cables
- Page 96

Hand Oiler for Switchgear Installations

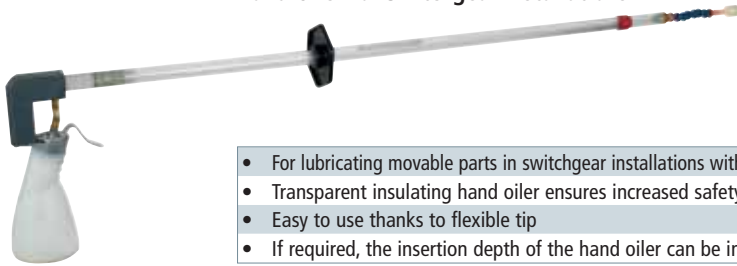

- For lubricating movable parts in switchgear installations with a nominal voltage up to 36 kV
 - Transparent insulating hand oiler ensures increased safety
 - Easy to use thanks to flexible tip
 - If required, the insertion depth of the hand oiler can be increased by means of optional extensions
- Page 124

Arc-Fault-Tested Protective Gloves with long Gauntlet



- Good touch sensitivity due to soft leather glove palm
 - Breathable materials maximise wearing comfort
 - Protection when removing NH fuse links
 - Enhanced arc fault protection up to the crook of the arm
 - Easy to put on
- Page 130

Arc-Fault-Tested Face Shield



- Protection even if scratched
 - Anti-mist
 - Cost saving long service life
 - Transparent chin protector provides all-round visibility
- Page 134

Fixed Arc Fault Protection System DEHNshort



- Arc fault protection system DEHNshort for detecting and extinguishing arc faults
 - Modular system consisting of a detection device and short-circuiter unit
 - Low space requirements thanks to compact design
 - Easy installation and commissioning
 - System adapted to the relevant system configuration
- Page 135

MicroΩmeter LoRe EaS



- Mobile measuring system for periodic technical tests of portable earthing and short-circuiting devices (EaS)
 - For determining minimum ohmic resistances of earthing and short-circuiting devices and the quality of electrical connections e.g. in case of conductor rails or switch contacts
 - Electronic transfer of measured values to the evaluation software via USB interface
 - Software-aided procedure and automatic documentation of results
 - Acoustic signal as soon as the limit values are exceeded
 - Calibrated when delivered
 - Software update via USB interface
- Page 150

Foreword 3

New Products	Cover
Our Promise – DEHN protects.	3
DEHN – International	4
DEHN – Information	5

**Products for Working according to the Five Safety Rules 11**

1. Disconnect completely – Operating Sticks	11
2. Secure against Re-Connection – Lock-out Systems	23
3. Verify that the Installation is dead – Voltage Detectors	25
3. Verify that the Installation is dead – Phase Comparators	45
3. Verify that the Installation is dead – DEHNcap Voltage Detecting System	49
4. Carry out Earthing and Short-Circuiting – EaS Devices	55
5. Provide Protection against adjacent live Parts – Insulating Protective Shutters	113

**Live Working 117**

Cleaning Equipment	117
Protective and Auxiliary Equipment	125

Arc Fault Protection 129

Passive Arc Fault Protection – DEHNcare®	129
Active Arc Fault Protection – DEHNshort, DEHNarc	135

**Service and Safety 143**

Periodic Tests for Safety Devices at DEHN + SÖHNE	144
---------------------------------------------------	-----

Further Equipment 149

Measuring Device	150
SDS Voltage Limiting Devices	151
Barriers	155
Discharge Devices	157
Storage Bags and Transport Cases	161
Accessories	165
Spare Parts	171
Kit Parts	172

Index 181

Part No. Index	181
Variant No. Index	187
Type Index	188
Notes	191
Key Words	192
General Terms of Sale	Cover

Safety Equipment Main Catalogue valid as of January 1, 2016

This catalogue replaces the Main Catalogue Safety Equipment 2014 / 2015.

We reserve the right to introduce changes in configuration and technology, dimensions, weights and materials within the scope of technical progress. Illustrations are not binding. We accept no liability for misprints, modifications and errors. Any reproduction of this catalogue, as a whole or in parts, is only allowed upon approval of DEHN + SÖHNE.



Our promise



"We are a reliable partner for our customers and employees."

Dr. Philipp Dehn
Managing Partner / CEO

DEHN protects.

Dear customers, friends, partners,

Every facet of life, whether business or private, is today highly complex. In order to cater to your ever increasing needs and, at the same time, promote your well-being, we provide innovations and manifold new products. We offer comprehensive protection solutions which, obviously, go hand in hand with the appropriate service. The key to the implementation of protection solutions for our and your own customers is in-depth and comprehensive consultation. Extended services and improved processes help both you and us to transform requirements into possibilities. We would like you, as our partner, to link up your protection requirements and needs with our services and expertise, in order for us both to reap the mutual advantages. Our new and constantly evolving protection concepts are designed to make your daily life and surroundings safer.

Of course, we also continue to provide all of Dehn's traditional, reliable products and safety solutions. We aim to be your safety partner worldwide for surge and lightning protection and safety equipment. Effective protection against the risks presented by lightning and surges for people and equipment is our business. A feel for the market, determination and ideas are the lifeblood for new safety products and concepts. This is the main focus of our family business and has, coupled with the pioneering spirit and innovation which have been our trademark for more than 100 years, made us a market leader with about 1700 employees.

The hub of our activities is in Neumarkt in Bavaria, Germany. It is here that developers work with project and product managers to further advance our protection technology. And it is here that we produce your safety products. Every day we endeavour to ensure that your business can continue to grow thanks to our innovative solutions and services. The DEHN brand name stands for innovation, consistent customer and market orientation and the highest possible quality. Now and in the future.

Take advantage of our range of surge and lightning protection and safety equipment and join us in providing a tad more safety.

I look forward to your interest and future cooperation with you.

Dr. Philipp Dehn



"Our customers are the focal point of our activities."

Helmut Pusch
Managing Director / CSO

Fair partnership for the best solution

Our goal is to be a reliable and fair partner for our industrial, commercial and technical customers all over the world. To this end, we always focus on the best protection solution.

Our sales teams in Germany, our global network of 20 subsidiaries and offices as well as more than 70 international sales partners ensure the competent and customer-oriented marketing of our products. Proximity to and close contact with our customers is of utmost importance to us, be it on-site support by our experienced team, our telephone hotline or personal contact at trade fairs. In hundreds of seminars, workshops and conferences held every year throughout the world, we impart practical knowledge on our products and solutions based on specific sample applications, technical and physical correlations and standardisation.

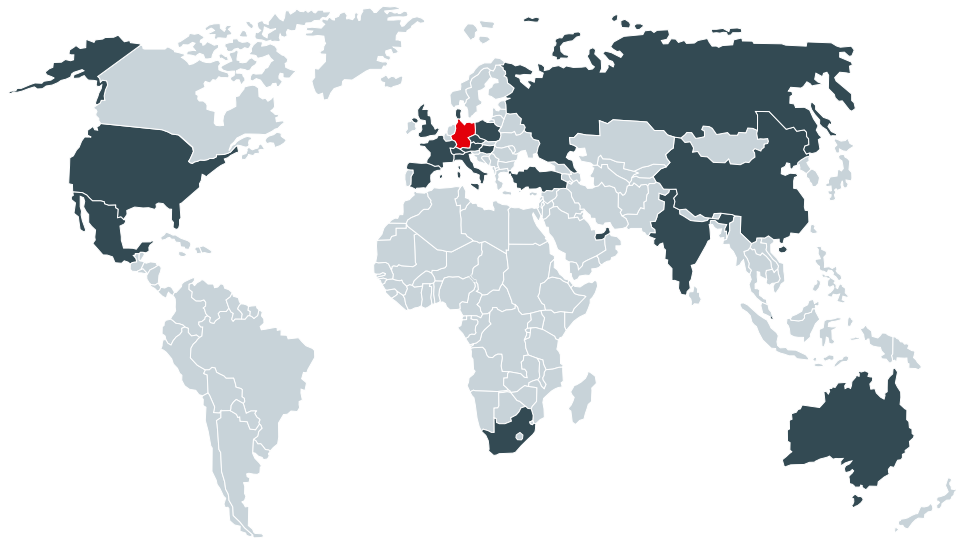

DEHN + SÖHNE GmbH + Co.KG.

**International
Sales Department**
sales@dehn.de
Phone +49 9181 906 1462
Fax +49 9181 906 1444

**International
Technical Services & Support**
ITSS@dehn.de
Phone +49 9181 906 1045
Fax +49 9181 906 1046

Subsidiaries and representative offices

Australia:	DEHN office Melbourne	www.dehn.com.au
Austria:	DEHN AUSTRIA GmbH	www.dehn.at
China:	DEHN Surge Protection (Shanghai) Co. Ltd.	www.dehn.cn
Czech Republic:	DEHN office Prague	www.dehn.cz
Denmark:	DESITEK A/S	www.desitek.dk
France:	DEHN FRANCE S.à.r.l.	www.dehn.fr
Great Britain:	DEHN (U.K.) LTD.	www.dehn.co.uk
Hungary:	DEHN office Budapest	www.dehn.hu
India:	DEHN INDIA Pvt. Ltd.	www.dehn.in
Italy:	DEHN ITALIA S.p.A.	www.dehn.it
Mexico:	DEHN PROTECTION MÉXICO, S.A. de C.V.	www.dehn.mx
Poland:	DEHN POLSKA Sp. z o.o.	www.dehn.pl
Russia:	OOO DEHN RUS	www.dehn-ru.com
Singapore:	DEHN (SEA) PTE. LTD.	www.dehn.sg
South Africa:	DEHN AFRICA (Pty) Ltd.	www.dehn-africa.com
Spain:	DEHN IBÉRICA Protecciones Eléctricas, S.A. Unipersonal	www.dehn.es
Switzerland:	ELVATEC AG	www.elvatec.ch
Turkey:	DEHN office Istanbul	www.dehn.com.tr
United Arab Emirates:	DEHN MIDDLE EAST FZE	www.dehn.ae
USA:	DEHN Inc.	www.dehn-usa.com

Sales activities in more than 70 countries worldwide

At www.dehn-international.com you can find your local contact partner.

1. VDE standards for safety equipment and devices

DIN VDE 0680

"Personal protective equipment, protective devices and apparatus for work on electrically energized systems up to 1000 V".

- Part 1 "Protective insulating devices"
- Part 3 "Operating rods and current collecting devices"
- Part 4 "Fuse handles for low-tension HRC-fuses"
- Part 6 "Single-pole voltage tester up to 250 V a.c."
- Part 7 "Socket spanner"

DIN VDE 0681

"Operating, testing and safe-guarding devices for work on electrically energized systems with rated voltages exceeding 1 kV".

- Part 1 "General requirements" for DIN VDE 0681 Parts 2 to 4 (and draft DIN VDE V 0681-1/01.2013)
- Part 2 "Operating rods" (and draft DIN VDE V 0681-1/01.2013)
- Part 3 "Fuse tongs" (and draft DIN VDE V 0681-1/01.2013)
- Part 6 "Voltage detectors to be used for over head contact systems 15 kV, 16 2/3 Hz"

DIN VDE 0682

"Apparatus and equipment for live working"

- Part 201 "Live working – Hand tools for use up to 1000 V a.c. and 1500 V d.c." (IEC/EN 60900)
- Part 211 "Live working – Insulating sticks and attachable devices – Part 1: Insulating sticks" (IEC 60832-1:2010)
- Part 212 "Live working – Insulating sticks and attachable devices – Part 2: Attachable devices" (IEC 60832-2:2010)
- Part 213 "Multi-purpose insulating sticks for electrical operations on high voltage installations"; German version EN 50508:2009
- Part 311 "Live working – Gloves of insulating material" (IEC/EN 60903)
- Part 312 "Sleeves of insulating material for live working" (IEC/EN 60984)
- Part 321 "Electrically insulating helmets for use on low voltage installations" (EN 50365)

- Part 401 "Two-pole low voltage type" (IEC/EN 61243-3)
- Part 411 "Capacitive type to be used for voltages exceeding 1 kV a.c." (IEC/EN 61243-1)
- Part 412 "Resistive type to be used for voltages of 1 kV to 36 kV" (IEC/EN 61243-2)
- Part 415 "Voltage detecting systems" (IEC/EN 61243-5)
- Part 417 "Voltage detectors – Distance voltage detectors" (preliminary standard DIN VDE V 0682-417/ 10.2013)
- Part 421 "Capacitive type to be used for voltages exceeding 1 kV a.c. and a frequency of 16.7 Hz" (draft 08.08)
- Part 431 "Portable phase comparators for voltages of 1 kV to 36 kV a.c." (IEC/EN 61481)
- Part 511 "Electrical insulating blankets" (IEC/EN 61112)
- Part 512 "Electrical insulating matting" (IEC/EN 61111)
- Part 513 "Flexible conductor covers (line hoses) of insulating material" (IEC/EN 61479)
- Part 551 "Rigid protective covers for live working on a.c. installations" (IEC/EN 61229)
- Part 552 "Insulating protective barriers above 1 kV"
- Part 603 "Telescopic sticks and telescopic measuring sticks" (IEC/EN 62193)
- Part 621 "Suction device for the cleaning of live parts with rated voltages above 1 kV up to 36 kV"
- Part 651 "Saddles, pole clamps (stick clamps) and accessories for live working" (IEC/EN 61236)
- Part 741 "Aerial devices with insulating boom used for life working exceeding 1 kV a.c." (IEC/EN 61057)

DIN VDE 0683

"Portable equipment for earthing or earthing and short-circuiting"

- Part 100 "Portable equipment for earthing or earthing and short-circuiting" (IEC/EN 61230)
- Part 200 "Earthing or earthing and short-circuiting equipment using lances as a short-circuiting device – Lance earthing" (IEC/EN 61219)

2. Abbreviations

2.1 Materials

Abbreviation	Material
Al	Aluminium
AlMgSi	Aluminium alloy
Cu	Electric copper, copper
Ms	Brass
StSt	Stainless steel
St	Steel
MCI	Malleable cast iron
ZDC	Zinc die casting
GRP	Glass-fibre reinforced plastic

3. Minimum lengths of insulating elements for

- 1) Operating sticks acc. to DIN VDE 0681
- 2) Voltage detectors acc. to IEC/EN 61243-1 (DIN VDE 0682-411)
- 3) Phase comparators acc. to IEC/EN 61481 (DIN VDE 0682-431)

Nominal voltage	Rated voltage	Minimum length of the insulating element $L_{I \min}$		
		1)	2)	3)
U_N *)	U_r			
up to 10 kV	12 kV	500 mm	520 mm	525 mm
20 kV	24 kV	500 mm	520 mm	525 mm
30 kV	36 kV	525 mm	520 mm	525 mm
45 kV	52 kV	720 mm	830 mm	—
60 kV	72.5 kV	900 mm	830 mm	—
110 kV	123 kV	1300 mm	1300 mm	—
150 kV	170 kV	1750 mm	1700 mm	—
220 kV	245 kV	2400 mm	2300 mm	—
380 kV	420 kV	3200 mm	3600 mm	—

*) For nominal voltages higher or lower than the nominal voltage indicated in the table above, a rated voltage closest to the required nominal voltage must be selected.
In extreme cases, the nominal voltage is equal to the rated voltage.

2.2 Coating materials









Abbreviation	Coating material
gal Sn	Tin-plated
gal Zn	Galvanised
tZn	Hot-dip galvanised
Bronze gal Sn	Bronze, tin-plated

2.3 Types of conductors

Abbreviation	Type of conductor
Fl	Flat conductor
Rd	Round conductor

4. Application

Operating sticks and equipment are basically subdivided into the following types:

Symbol	Application
	Not suitable for use in wet weather conditions For indoor and outdoor installations For use in indoor and outdoor installations, but not in wet weather conditions.
	Suitable for use in wet weather conditions For indoor and outdoor installations For use in indoor and outdoor installations, in all weather conditions (even if the operating stick gets wet).
	For indoor installations only!
	Switchgear installations
	Overhead lines
	Components for railway applications
	New products
	see www.dehn-international.com Products / Selection guides and configurators / EaS configurator

5. Maintenance tests



Maintenance test criteria for protective and auxiliary equipment			
	DGUV regulation 3 (former BGV A3)	VDE 0105-100	Equipment standard
Earthing and short-circuiting devices	§ 5 (1) [... It shall be checked whether equipment is in good order and condition...] (2) [... at certain intervals. The intervals must be chosen so that the defects to be expected are detected in due time.]	5.3.101 [Periodic inspections, general information.]	IEC/EN 61230, Annex C (informative), C 3.2.2 [It is recommended to perform a cut test and visual inspection at least every five years in case of outdoor use and every ten years in case of indoor use.]
Voltage detectors, phase comparators and voltage detecting systems	§ 5: according to table 1C [Tests for compliance with the limit values specified in the electrotechnical rules must be carried out at least every six years.]	6.2.3 [Inspection at least before and, if possible, after each use], 5.3.101 [Periodic inspections, general information.]	IEC/EN 61243-1, Annex G (informative): Tests for capacitive voltage detectors > 1 kV [Voltage detectors that have not been subjected to a maintenance test within six years should not be used.] IEC/EN 61243-5: Tests for voltage detecting systems (VDS) IEC/EN 61481, Annex G (informative): Tests for phase comparators between 1 and 36 kV a.c. [The maximum interval between maintenance tests is six years.]
Operating and earthing sticks	§ 5: according to table 1C [A visual inspection for signs of damage and defects must be carried out prior to each use.]	5.3.101 [Periodic inspections, general information.]	VDE 0681-1 to 3: Tests for operating sticks Note: Operating sticks also have to be subjected to electrotechnical tests. DEHN + SÖHNE recommends to use the test intervals of voltage detectors. E DIN VDE V 0681-1 to 3 Annex B (informative) [Maximum interval between maintenance tests for operating sticks is six years.]

6. Instructions for use



The current instructions for use and further details of our products can be found at www.dehn-international.com.

Product search:

www.dehn-international.com/search ⇒ Enter Part No. ⇒  More

When working in and on electrical installations, the following five safety rules must be observed to prevent electrical accidents:



Five safety rules:

1. Disconnect completely

The electrical installation must be disconnected from live parts on all poles.

2. Secure against re-connection

Re-connection must be reliably prevented to ensure that an installation where work is in progress is not accidentally re-connected. This is achieved, for example, by replacing the unscrewed fuses in low-voltage installations by lockable lock-out devices.

3. Verify that the installation is dead

Suitable measuring / test equipment such as voltage detectors must be used to verify on all poles that the installation is dead.

4. Carry out earthing and short-circuiting

After verifying that the installation is dead, the cables and the earthing system are connected to short-circuit-proof earthing and short-circuiting devices. It must be observed that the relevant parts must be earthed before they are short-circuited.

5. Provide protection against adjacent live parts

According to the five safety rules, adjacent parts are parts located in the vicinity zone. If parts of an electrical installation in the vicinity of the work location cannot be disconnected, additional precautions must be taken before work starts as is the case with work in the vicinity of live parts.

Work according to the Five Safety Rules

1. Disconnect completely – Operating Sticks

Product	Type	Nominal voltage U_N / Frequency f_N	Application	Page
IS Insulating Sticks				
	IS Insulating Sticks	up to 123 kV / 50 Hz	For use in indoor and outdoor installations Screw-on switching stick head allows for use as switching stick Supporting head with hexagon shaft or T pin shaft For use as earthing stick For use as operating stick for insulating protective shutters	10
SCS Switching Sticks				
	SCS Switching Sticks	up to 123 kV / 50 Hz	For indoor and outdoor installations Fully insulated, massive switching stick head Allows deep access into the installation For use as operating stick for insulating protective shutters	14
RST Rescue Rods				
	RST Rescue Rods	up to 36 kV / 50 Hz	For use in indoor and outdoor installations Fully insulated and fixed rescue hook For rescuing persons from the live working zone in the event of an electrical accident	15
SZ Fuse Tongs				
	SZ Fuse Tongs	up to 36 kV / 50 Hz	Operating head with two adjustable jaws Straight or 20° angled operating head Secure clamping Wide clamping range from Ø30 to 90 mm	16
Wireless Inspection Camera				
	Wireless Inspection Camera	up to 36 kV / 15 ... 60 Hz	For visual inspection and documentation of electrical installations Wireless WiFi camera operation via smartphone/tablet No downtimes due to disconnection of the installation	18
Ice Removal Rod				
	Ice Removal Rod	up to 15 kV / 16.5 Hz and 25 kV / 50 Hz	For removing icicles in the vicinity of live parts Massive icicle removal hammer With telescopic handle	20
Insulating Stick with Crank Handle				
	Insulating Stick with Crank Handle	up to 36 kV	For emergency operating of engine drives For indoor and outdoor installations	21
Insulating Stick Kit for Cleaning the Windscreens of E-Locomotives				
	Insulating Stick Kit	up to 7.5 kV / d.c. and 25 kV / a.c.	Insulating stick kit for cleaning the windscreens of electric locomotives	22
Storage Bags and Transport Cases				
	Cases: Sheet steel or plastic Bags: Artificial leather or canvas			161
Maintenance Tests according to German regulations DGUV Vorschrift 3 (former BGV A3)				
	According to German regulations DGUV Vorschrift 3 (former BGV A3), operating sticks have to be tested for compliance with the prescribed limits as stated in the Electrical Safety Rules. This test is performed in the high-voltage test laboratory of DEHN + SÖHNE and includes – measurement of the leakage current, – test for protection against bridging, – visual inspection, manual tests and measurements. This maintenance test is documented in a test report and on the device. Prior to each use, operating sticks must be visually inspected for signs of damage or any other defect.			144

1. Disconnect completely – Operating Sticks

IS Insulating Sticks

1. Operating Sticks



Switching a disconnector by means of an IS SK insulating stick fitted with switching stick head

Nominal Voltages up to 123 kV / 50 Hz

Easy and safe working

- Cost-effective since the installation of different supporting heads allows universal use
- Easy handling

General Information:	
Standard (switching stick head)	E DIN VDE V 0681-2
Standard (insulating stick)	E DIN VDE V 0681-1
Standard (operating stick)	DIN VDE 0682-552
Not suitable for use in wet weather conditions	☀
For use in wet weather conditions	☔
For	Indoor and outdoor installations
Material	Glass-fibre reinforced polyester tube



IS SK insulating stick fitted with SSK M12 switching stick head.



IS SQ insulating stick fitted with SSK SQ switching stick head. The black knurled nut is locked into position using the insulating stick.

Insulating Stick, Hexagon Shaft

Operating head with spring locking mechanism and M12 threaded bushing

- Can be used as switching and operating stick by attaching a SSK M12 switching stick head
- Can be used as earthing stick
- Handle closed with end cap

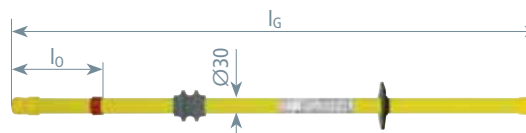

Type	IS 36 SK 1000	IS 36 SK 1500	ISN 36 SK 1000	ISN 36 SK 1500
Part No.	766 001	766 002	766 210	766 215
Nominal voltage (U _N)	1 ... 36 kV	1 ... 36 kV	1 ... 36 kV	1 ... 36 kV
Total length (l _G)	1000 mm	1500 mm	1000 mm	1500 mm
Insertion depth (l _o)	175 mm	475 mm	175 mm	475 mm
Diameter	30 mm	30 mm	30 mm	30 mm
For	☀	☀	☔	☔

Insulating Stick, T Pin Shaft

Operating head with spring-loaded bayonet coupling

- Can be used as switching and operating stick by attaching a SSK SQ switching stick head
- Can be used as operating stick for inserting insulating protective shutters
- Can be used as earthing stick
- Handle closed with end cap

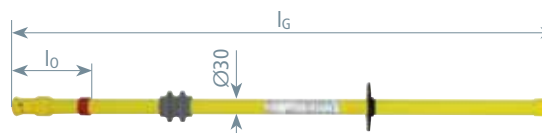

Type	IS 36 SQ 1000	IS 36 SQ 1500	ISN 36 SQ 1000	ISN 36 SQ 1500
Part No.	766 311	766 315	766 211	766 216
Nominal voltage (U _N)	1 ... 36 kV	1 ... 36 kV	1 ... 36 kV	1 ... 36 kV
Max. load on the operating head *)	17 kg	17 kg	17 kg	17 kg
Total length (l _G)	1025 mm	1525 mm	1025 mm	1525 mm
Insertion depth (l _o)	150 mm	500 mm	150 mm	500 mm
Diameter	30 mm	30 mm	30 mm	30 mm
For	☀	☀	☔	☔

*) Max. shutter weight when inserting insulating protective shutters

1. Disconnect completely – Operating Sticks

Insulating Stick, Hexagon Shaft, Plug-in Coupling

Operating head with spring locking mechanism and M12 threaded bushing

- Can be used as switching and operating stick by attaching a SSK M12 switching stick head
- Can be used as earthing stick
- Handle closed with plastic plug-in coupling for extending the handle

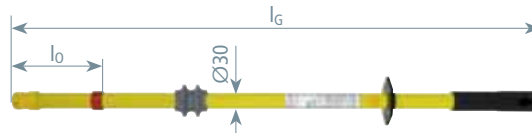

Type	IS 36 SK STK 1000	IS 123 SK STK 2000	ISN 36 SK STK 1000
Part No.	766 100	766 122	766 111
Nominal voltage (U _N)	1 ... 36 kV	1 ... 123 kV	1 ... 36 kV
Total length (l _G)	1000 mm	2000 mm	1000 mm
Insertion depth (l ₀)	175 mm	200 mm	175 mm
Diameter	30 mm	30 mm	30 mm
For			



Insulating Stick, T Pin Shaft, Plug-in Coupling

Operating head with spring-loaded bayonet coupling

- Can be used as switching and operating stick by attaching a SSK SQ switching stick head
- Can be used as operating stick for inserting insulating protective shutters
- Can be used as earthing stick
- Handle closed with plastic plug-in coupling for extending the handle

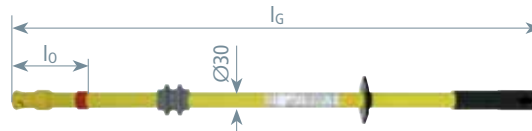

Type	IS 36 SQ STK 1000	IS 123 SQ STK 2000	ISN 36 SQ STK 1000
Part No.	766 301	766 322	766 310
Nominal voltage (U _N)	1 ... 36 kV	1 ... 123 kV	1 ... 36 kV
Max. load on the operating head *)	17 kg	8 kg	17 kg
Total length (l _G)	1025 mm	2000 mm	1025 mm
Insertion depth (l ₀)	150 mm	200 mm	150 mm
Diameter	30 mm	30 mm	30 mm
For			

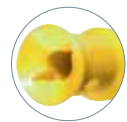

*) Max. shutter weight when inserting insulating protective shutters

Insulating Stick, detachable, Hexagon Shaft, Plug-in Coupling

Operating head with spring locking mechanism and threaded bushing M12

- Can be used as switching stick and operating stick by attaching a switching stick head SSK M12
- Can be used as earthing stick
- Can be used as handle termination with plug-in coupling for extending the handle

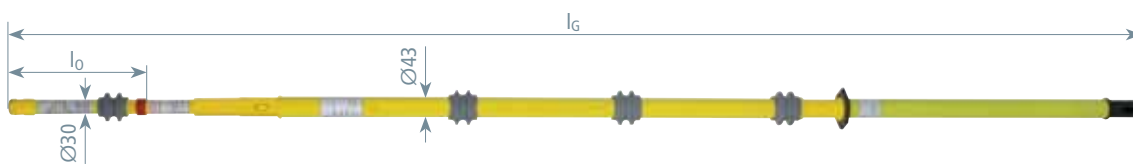

Type	ISN 123 SK STK 2500
Part No.	766 222
Nominal voltage (U _N)	123 kV
Total length (l _G)	2490 mm
Insertion depth (l ₀)	285 mm
Diameter	30 / 43 mm
For	



1. Disconnect completely – Operating Sticks

Insulating Stick, detachable, T Pin Shaft, Plug-in Coupling

Operating head with bayonet coupling with spring locking mechanism

- Can be used as switching stick and operating stick by attaching the switching stick head SSK SQ
- Can be used as operating stick for inserting insulating protective shutters
- Can be used as earthing stick
- Can be used as handle termination with end cap

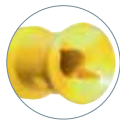
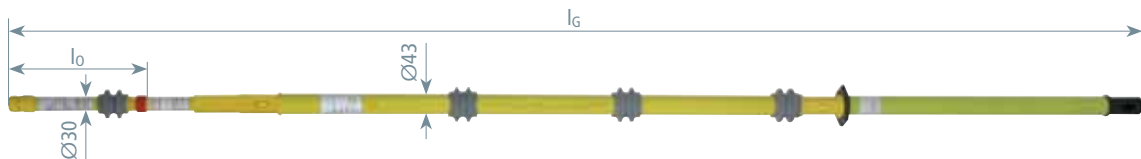

Type	ISN 123 SQ STK 2500
Part No.	766 332
Nominal voltage (UN)	123 kV
Max. load on the operating head *)	15 kg
Total length (lg)	2495 mm
Insertion depth (lo)	290 mm
Diameter	30 / 43 mm
For	

Accessories for IS Insulating Sticks

Screw-on Switching Stick Head for IS SK Insulating Sticks

With M12 thread.
In accordance with E DIN VDE V 0681-2.



Type	SSK M12
Part No.	765 005
Material	Steel, plastic-sheathed

Switching Stick Head for IS SQ Insulating Sticks

With T pin shaft (bayonet locking mechanism).
In accordance with E DIN VDE V 0681-2.
T pin shaft in accordance with DIN 48087.
Switching stick head is fixed on the insulating stick via the knurled nut.



Type	SSK SQ
Part No.	765 009
Material	Polyamide

1. Disconnect completely – Operating Sticks

Insulating Stick, Plug-in Coupling at Both Ends

Plug-in coupling at both ends for attaching extension elements, operating heads or adapters.

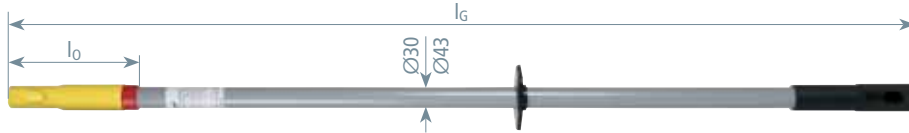

General Information

Nominal voltage (U _N)	Up to 36 kV
-----------------------------------	-------------

Type	IS 36 STK 30 1280	IS 36 STK 43 1280	ISN 36 STK 30 1280	ISN 36 STK 43 1280
Part No.	766 363	766 463	766 367	766 468
Total length (l _G)	1280 mm	1280 mm	1280 mm	1280 mm
Diameter	30 mm	43 mm	30 mm	43 mm
For				

Type	ISN 36 STK 930SN7688
Part No.	766 362 ^{NEW}
Total length (l _G)	930 mm
Diameter	30 mm
For	

NEW

Accessories for IS Insulating Sticks

STK Switching Stick Head

Type	SSK 36 STK 560
Part No.	766 164
Diameter	30 mm
Total length (l _G)	560 mm

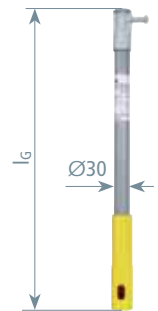

STK Operating Head / long T Pin Shaft

Aluminium cone coupling with adjusting ring (bayonet locking mechanism) for earthing and short-circuiting in outdoor installations.

Type	AK SQL STK 365
Part No.	766 465
Diameter	43 mm
Total length (l _G)	365 mm

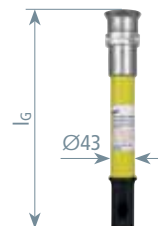

STK Operating Head / Hexagon Shaft

For indoor use.

Type	AK 36 SK STK 330
Part No.	766 364
Diameter	30 mm
Total length (l _G)	330 mm

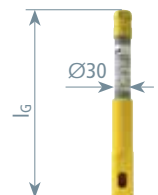

STK Operating Head / T Pin Shaft

For indoor use.

Type	AK 36 SQ STK 360
Part No.	766 365
Diameter	30 mm
Total length (l _G)	360 mm

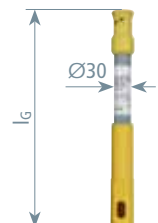

1. Disconnect completely – Operating Sticks

SCS Switching Sticks



Switching a disconnector by means of an SCS switching stick

Nominal Voltages up to 123 kV / 50 Hz

Easy and safe working

- Cost-effective
- User-friendly

General Information:	
Standard (switching stick head)	E DIN VDE V 0681-2
Standard (switching stick)	E DIN VDE V 0681-1 and -2
Standard (insulating stick)	E DIN VDE V 0681-1
Standard (operating stick)	DIN VDE 0682-552
Not suitable for use in wet weather conditions	☀
For use in wet weather conditions	☔
For	For indoor and outdoor installations
Design	Fully insulated, massive switching stick head
Material (insulating tube)	Glass-fibre reinforced polyester tube
Material (switching pin)	Steel, plastic-sheathed

Nominal Voltages up to 72.5 kV

With end cap.

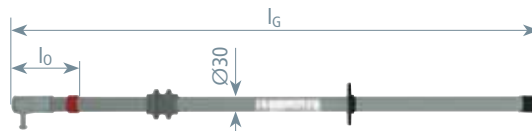

Type	SCS 36 1000	SCS 36 1500	SCS 36 2000	SCS 72 1500
Part No.	763 610	763 611	763 612	763 615
Nominal voltage (U _N)	1 ... 36 kV	1 ... 36 kV	1 ... 36 kV	1 ... 72.5 kV
Max. load on the operating head	17 kg	17 kg	9 kg	—
Total length (l _G)	1030 mm	1500 mm	2000 mm	1500 mm
Insertion depth (l _o)	135 mm	415 mm	765 mm	290 mm
For	☀	☀	☀	☀

Type	SCS 72 2000	SCSN 36 1000	SCSN 36 1500
Part No.	763 620	763 510	763 511
Nominal voltage (U _N)	1 ... 72.5 kV	1 ... 36 kV	1 ... 36 kV
Max. load on the operating head	—	17 kg	17 kg
Total length (l _G)	2000 mm	1030 mm	1500 mm
Insertion depth (l _o)	690 mm	135 mm	415 mm
For	☀	☔	☔

Nominal Voltages up to 123 kV

Handle sealed with plastic plug-in coupling for extending the handle.

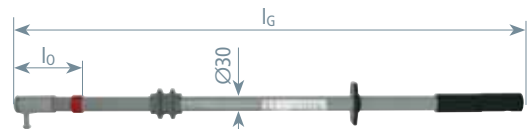

Type	SCS 36 STK 1000	SCS 72 STK 1500	SCS 123 STK 2000
Part No.	763 100	763 150	763 180
Nominal voltage (U _N)	1 ... 36 kV	1 ... 72.5 kV	1 ... 123 kV
Max. load on the operating head	17 kg	—	—
Total length (l _G)	1000 mm	1500 mm	2000 mm
Insertion depth (l _o)	135 mm	290 mm	200 mm
For	☀	☀	☀

Type	SCSN 36 STK 1000	SCSN 36 STK 2000
Part No.	763 111	763 112 ^{NEW}
Nominal voltage (U _N)	1 ... 36 kV	1 ... 36 kV
Max. load on the operating head	17 kg	9 kg
Total length (l _G)	1000 mm	2000 mm
Insertion depth (l _o)	135 mm	765 mm
For	☔	☔

1. Disconnect completely – Operating Sticks

Nominal Voltages up to 123 kV, detachable

Handle sealed with plastic plug-in coupling for extending the handle.

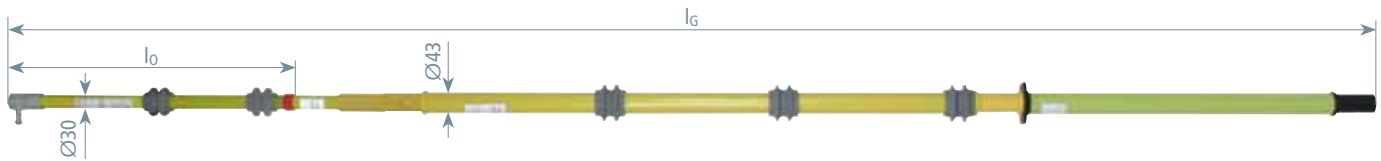

Type	SCSN 123 STK 2800
Part No.	763 181
Nominal voltage (U _N)	110 ... 123 kV
Total length (l _G)	2840 mm
Insertion depth (l ₀)	640 mm
For	

RST Rescue Rods

Nominal Voltages up to 36 kV / 50 Hz

- For use in indoor and outdoor installations
- Fixed rescue hook (protected against bridging)
- For rescuing persons weighing up to approximately 100 kg from the live working zone in the event of an electrical accident



Insulated RST rescue rod used to rescue an electrified victim from the live working zone

General Information:	
Standard	Based on DIN VDE 0681-1
Not suitable for use in wet weather conditions	
Material (hook)	PVC-HI solid rod
Material (insulating tube)	Glass-fibre reinforced polyester tube
End fitting	Non-slip plastic cap

Rescue Rod up to 36 kV

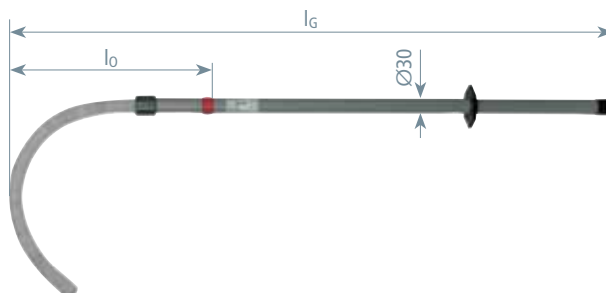

Type RST 36 ...	1000	1500	2000
Part No.	766 040	766 041	766 042
Nominal voltage (U _N)	1 ... 36 kV	1 ... 36 kV	1 ... 36 kV
Total length (l _G)	1235 mm	1695 mm	2195 mm
Insertion depth (l ₀)	410 mm	620 mm	970 mm

1. Disconnect completely – Operating Sticks

SZ Fuse Tongs



Nominal Voltages up to 36 kV / 50 Hz

Easy and safe working

- User-friendly



General Information:	
Standard	DIN VDE 0681-3
Not suitable for use in wet weather conditions	☀
Design	Straight and 20° angled clamp body
Clamping range	Wide clamping range from Ø30 to 90 mm
Material (insulating stick)	Glass-fibre reinforced polyester tube
Material (operating head)	Glass-fibre reinforced polyamide
Material (adjustable handle)	Polyamide
Material (reducing insert)	Polyamide
Colour	Grey ●

SZ fuse tongs for inserting and removing HH fuses



The reducing insert delivered with the SZ fuse tong allows low clamping ranges from Ø30 to 50 mm. Without reducing insert, HV HBC fuses from Ø50 to 90 mm can be actuated.



In practice, the 20° angled operating head allows safe and easy actuation of HH fuses that are not easily accessible.

1. Disconnect completely – Operating Sticks

Straight SZ Fuse Tong

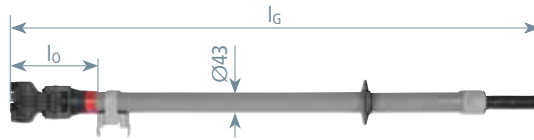

Type SZ HH ...	1060	1250	1500
Part No.	765 040	765 041	765 042
Nominal voltage (U _N)	1 ... 36 kV	1 ... 36 kV	1 ... 36 kV
Clamping range	30 ... 50 ^{*)} / 50 ... 90 mm	30 ... 50 ^{*)} / 50 ... 90 mm	30 ... 50 ^{*)} / 50 ... 90 mm
Total length (l _G)	1060 mm	1250 mm	1500 mm
Insertion depth (l _o)	185 mm	185 mm	185 mm

^{*)} Only if used with reducing insert

20° angled SZ Fuse Tong

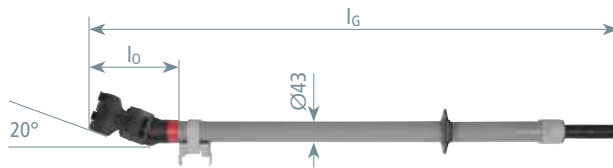

Type SZ HH ...	W20 1070	W20 1250	W20 1500
Part No.	765 050	765 051	765 052
Nominal voltage (U _N)	1 ... 36 kV	1 ... 36 kV	1 ... 36 kV
Clamping range	30 ... 50 ^{*)} / 50 ... 90 mm	30 ... 50 ^{*)} / 50 ... 90 mm	30 ... 50 ^{*)} / 50 ... 90 mm
Total length (l _G)	1070 mm	1250 mm	1500 mm
Insertion depth (l _o)	195 mm	195 mm	195 mm

^{*)} Only if used with reducing insert

Accessories for SZ Fuse Tong

Storage Device for HH Fuses

Wall-mounted.

Type	HV 3HH ET
Part No.	700 005
For	HH fuses



Storage Device for HH Fuses and Fuse Tong

Wall-mounted.

Type	HV 3HH SZ ET
Part No.	700 004
For	HH fuses and fuse tong



Storage Device Kit for HH Fuses or HH Fuses and Fuse Tong

Wall-mounted.

Type	HV 3HH	HV 3HH SZ
Part No.	700 015	700 014
Consisting of	2x HV 3HH ET	1x HV 3HH ET and 1x HV 3HH ZS ET



1. Disconnect completely – Operating Sticks

Wireless Inspection Camera



Nominal Voltages up to 36 kV /15 ... 60 Hz

- For visual inspection and documentation of electrical installations
- Flexible operating head for difficult-to-access installations
- Wireless WiFi camera operation via smartphone / tablet
- No downtimes due to disconnection of the installation



General Information:	
Standard (operating head)	based on EN 50508 (DIN VDE 0682-213)
Operating temperature range (camera and battery) (T _U)	0 °C ... +40 °C
Not suitable for use in wet weather conditions	☀
Material (enclosure)	PUR
Material, colour (camera)	plastic, black

Visual inspection of the insulator.



Type	SET DIGIK
Part No.	766 390 <small>NEW</small>
Nominal voltage (U _N)	up to 36 kV
Resolution	18.2 megapixel
Objective	wide-angle lens (10x optical zoom)
Image stabiliser	optical image stabiliser
Focus	autofocus
Equipment	PlayMemories Home App, Wi-Fi integrated
Interfaces	micro-USB (USB 2.0) port
Battery life	approx. 220 images
Video function	HD video recording MP4 format possible
Dimensions (camera)	62.4 x 67.8 x 33.3
Dimensions (enclosure)	95 x 88 mm
Total length (operating head)	260 mm
Dimensions (case)	395 x 290 x 105 mm

Note: SET DIGIK is a complete set in a case. It consists of a camera with battery, USB cable, smartphone attachment, housing, adapter with gear coupling and transport case.



*)

*)

*) Handle and insulating rod are not included.

1. Disconnect completely – Operating Sticks

Accessories for Wireless Inspection Camera

Handle with Gear Coupling

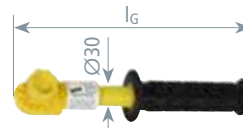

Type	HG ZK 230
Part No.	766 393
Nominal voltage U_N AC	up to 1000 V / 15 ... 60 Hz
Nominal voltage U_N DC	up to 1500 V
Diameter	30 mm
Total length (l_G)	230 mm

Insulating Stick with Handle and Plug-in Coupling

Single-part (Part No. 785 325) or modular (Part No. 785 315).

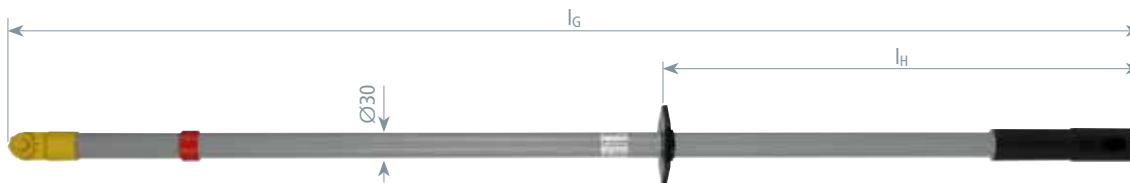

Type	IS 36 ZK STK 1300	IS T 36 ZK STK 1300
Part No.	785 325	785 315
Diameter	30 mm	30 mm
Total length (l_G)	1300 mm	1300 mm
Length (handle) (l_H)	560 mm	560 mm

IS STK Insulating Stick with Plug-in Coupling

Plug-in coupling at both ends for attaching extension elements, operating heads or adapters.

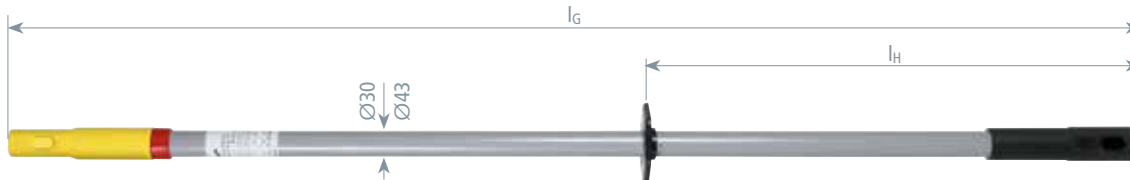

Type	IS 36 STK 30 1280	IS 36 STK 43 1280
Part No.	766 363	766 463
Diameter	30 mm	43 mm
Total length (l_G)	1280 mm	1280 mm
Length (handle) (l_H)	560 mm	560 mm

Adapter with Gear Coupling

With plug-in coupling.

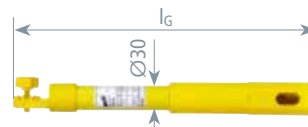

Type	AD ZK STK 30 360
Part No.	766 359
Diameter	30 mm
Total length (l_G)	360 mm

1. Disconnect completely – Operating Sticks

Ice Removal Rod



Removing icicles on a tunnel entrance.

Nominal Voltages up to 25 kV

- For removing icicles in the vicinity of live parts e.g. outdoor overhead contact lines or tunnel systems
- Massive icicle removal hammer made of insulating material
- Insulating stick for 15 kV / 16.7 Hz and 25 kV / 50 Hz systems
- With telescopic handle up to a total length of 3420 mm to 5270 mm



General Information:	
Standard (operating head)	Based on DIN VDE 0682-411 and DIN VDE 0681-1
Standard (insulating stick)	Based on DIN VDE 0682-411 and DIN VDE 0681-1
For use in wet weather conditions	
Material (insulating stick)	Glass-fibre reinforced polyester tube
Material (handle)	Glass-fibre reinforced polyester tube

NEW

Operating Head (Hammer)

With plug-in coupling

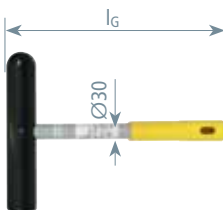

Type	AK 25 ESH STK SN7361
Part No.	766 372 <small>NEW</small>
Nominal voltage (U _N)	1 ... 25 kV
Total length (l _G)	400 mm
Dimensions (operating head)	300 x 56 mm
For	

Insulating Stick

With plug-in coupling for operating head (hammer)

NEW

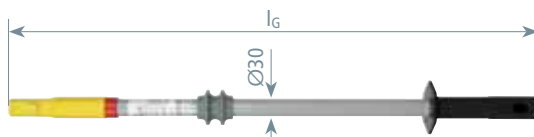

Type	ISN 25 STK 900SN7360
Part No.	766 371 <small>NEW</small>
Nominal voltage (U _N)	1 ... 25 kV
Total length (l _G)	920 mm
For	

Telescopic Extension Handle

With plug-in coupling for the insulating stick and end fitting with eye.

NEW



Type	HVTC STK 4100 SN7359
Part No.	766 469 <small>NEW</small>
Total length (l _{G max} / l _{G min})	4120 / 2290 mm
For	

1. Disconnect completely – Operating Sticks

Insulating Stick with Crank Handle

Nominal Voltages up to 36 kV / 15 ... 60 Hz

- For emergency operating of engine drives
- For indoor and outdoor installations



General Information:	
Standard	DIN VDE 0681-1
Not suitable for use in wet weather conditions	☀
Material (operating head)	Plastic
Material (extension)	Glass-fibre reinforced polyester tube
Material (test unit)	Glass-fibre reinforced polyester tube

Operating Head

With hexagon shaft 24 mm and hexagon coupling 12 mm.

Type	AK SK24 SK12
Part No.	763 712 NEW
Total length (l _G)	120 mm
Diameter	30 mm
For	☀



Insulating Stick with Crank Handle

With hexagon coupling 12 mm and button.

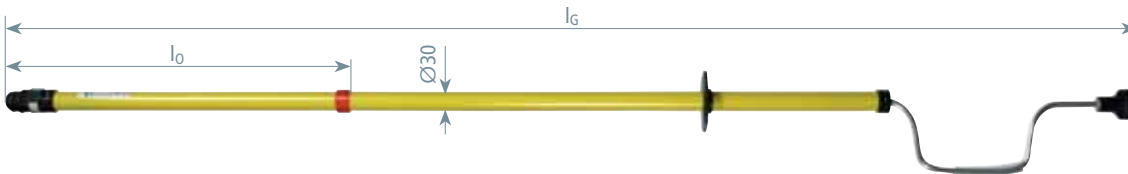

Type	IS SK12 HK 1720
Part No.	763 710 NEW
Nominal voltage (U _N)	1 ... 36 kV
Total length (l _G)	1720 mm
Diameter	30 mm
For	☀

Insulating Stick Extension

With hexagon coupling 12 mm and button.

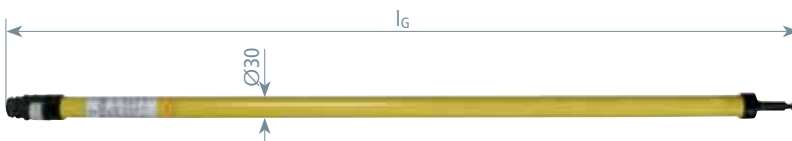

Type	ISV SK12 1060
Part No.	763 711 NEW
Nominal voltage (U _N)	1 ... 36 kV
Total length (l _G)	1060 mm
Diameter	30 mm
For	☀

1. Disconnect completely – Operating Sticks

Insulating Stick Kit for Cleaning the Windscreens of Electric Locomotives



Nominal Voltages up to 7.5 kV / d.c. and 25 kV / a.c.

- For cleaning the windscreens of electric locomotives
- Protection against accidental contact with live parts (e.g. overhead contact lines)
- Adjustable inclination angle of the operating head



General Information:	
Standard	Wet test in accordance with EN/IEC 61243-1 (DIN VDE 0682-411)
For use in wet weather conditions	
Material (insulating tube)	Glass-fibre reinforced polyester tube
End fitting	Non-slip plastic cap

Insulating stick kit used for cleaning the windscreen of an electric locomotive



Adapter with gear coupling for attaching the cleaning head.



The hook-and-loop fastener allows fast replacement of the cleaning pad.



The universal gear coupling can be adjusted from 0° to 90° in 30° increments.

Note:

In accordance with EN/IEC 61243-1 (DIN VDE 0682-411), IS 25 ZK 2885 insulating sticks and AD ZK 25 200 adapters can also be used in wet weather conditions for nominal voltages up to 7.5 kV d.c. and 25 kV a.c. The cleaning agent must not exceed the maximum conductivity of 1000 µS / cm. Due to the risk of bridging, water and cleaning agents must not be used to clean live parts of installations.

Insulating Stick Kit for Cleaning Windscreens

Parts list:			
Pos.	Part No.	Pos.	Part No.
1	766 048	3	766 056
2	766 055	4	766 057

For more detailed information on these products, see Accessories chapter.

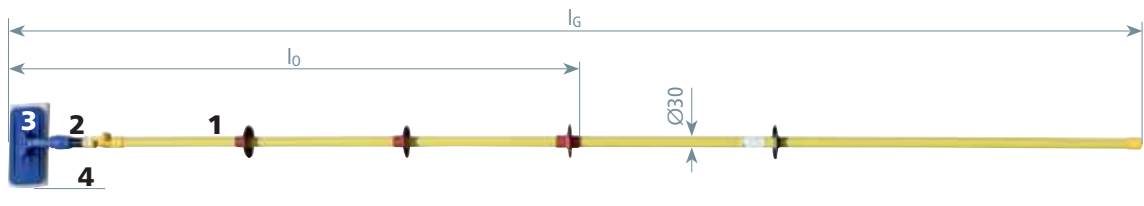

Type	IS 25 ZK RK 3160
Part No.	766 340
Nominal voltage U _N a.c.	Up to 25 kV
Nominal voltage U _N d.c.	Up to 7.5 kV
Total length (l _G)	3160 mm
Insertion depth (l ₀)	1630 mm

Lock-out Systems

Nominal Voltages up to 1000 V

- Protection against re-connection
- Symbol "No switch" [Do not close the circuit] acc. to German regulations (VBG 125)



General Information:	
Standard	VBG 125 and DIN 40008
For	Indoor installations



Lock-out system for three modular widths.

Insulating Plug

For screw inserts.

Type SE ...	E14	E18	E27 E33
Part No.	785 639	785 650	785 640
Size	E14	E18	E27 and 33
Diameter	20 mm	25 mm	45 mm
Dimensions	Ø20 x 40 mm	Ø25 x 40 mm	Ø45 x 55 mm
PU	10 pc(s)	10 pc(s)	10 pc(s)



Insulating Blade

For NH fuse holders and distribution blocks.

Type SE ...	NH00	NH0	NH1	NH2 3
Part No.	785 641	785 642	785 643	785 644
Size	00	0	1	2 and 3
Blade	13 x 5 mm	38 x 5 mm	38 x 5 mm	38 x 5 mm
Dimensions	80 mm	125 mm	135 mm	150 mm
PU	10 pc(s)	10 pc(s)	10 pc(s)	10 pc(s)



Lock-out System

For single-pole and multipole circuit breakers with a clamping range of 45 mm.









Type SE ...	REG 1TE	REG 2TE	REG 3TE
Part No.	785 638	785 652	785 637
Size	1 modular width	2 modular widths	3 modular widths
Dimensions	52 x 17 mm	52 x 34 mm	52 x 51 mm
PU	10 pc(s)	10 pc(s)	10 pc(s)



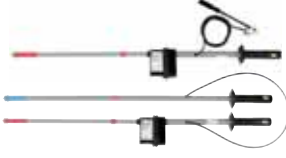

DEHN protects.

3. Verify that the Installation is dead – Voltage Detectors

Product	Type	Nominal voltage U_N / Frequency f_N	Application, Indication	Page
PHE III Voltage Detector				
	PHE III	3 / 6 / 10 / 20 / 30 kV / 50 Hz	For use in wet weather conditions	28
	PHE III ZK Indicator with test prod	3.3 / 6.6 / 11 / 22 / 33 kV / 50 Hz 3...10 / 6...20 / 10...30 kV / 50 Hz 3.3...11 / 6.6...22 / 11...33 kV / 50 Hz 3...10 / 10...30 kV / 50 Hz switchable	For indoor and outdoor installations With self-testing element Visual and acoustic indicator Easy transport	31
	PHE III Kit	3.3...11 / 11...33 kV / 50 Hz switchable 6...20 / 10...30 kV / 50 Hz test kit 20 kV / 50 Hz 60...110 / 50 Hz	Fast battery replacement without additional tools	32
PHE Voltage Detector				
	PHE	3 / 6 / 10 / 20 / 30 kV / 50 Hz 3...10 / 6...20 / 15...30 kV / 50 Hz	For use in wet weather conditions For indoor and outdoor installations	34
	PHE Kit	3...10 / 6...20 / 15...30 kV / 50 Hz switchable 15 kV / 16.7 Hz	With self-testing element Visual indicator Easy transport	36
Non-Contact Voltage Detector				
	ASP	110...420 kV / 50 Hz or 16.7 Hz	For use in wet weather conditions Non-contact voltage detector	37
	HSA	1...420 kV / 50 Hz or 16.7 Hz	For overhead lines and outdoor switching stations With self-testing element Visual and acoustic indicator	39
PHG II Voltage Detector				
	PHG II	6 / 10 / 20 kV / 50 Hz	For indoor installations only Three LED indicator lights LEDs staggered at 120° allow for better visibility of the indication Passive voltage detector without batteries	41
PHE/G d.c. Voltage Detector				
	PHE/G	1...24 kV / d.c. voltage	For use in wet weather conditions For indoor and outdoor installations With self-testing element Visual indicator Easy transport Two-pole unit (one stick / two sticks)	42
SPN Voltage Detector				
	SPN	100...500 V 120...1000 V	For use in wet weather conditions Two versions with different measuring ranges No batteries required Can also be used in overhead line networks by attaching extension prods	44
Storage Bags and Transport Cases				
		Cases: Sheet steel or plastic Bags: Artificial leather or canvas		161
Maintenance Tests according to German regulations DGUV Vorschrift 3 (former BGV A3)				
		According to German regulations DGUV Vorschrift 3 (former BGV A3), voltage detectors have to be tested for compliance with the prescribed limits as stated in the Electrical Safety Rules. This test is performed in the high-voltage test laboratory of DEHN + SÖHNE and includes – measurement of the leakage current, – test for clear indication, – test for protection against bridging, – visual inspection, manual tests and measurements. This maintenance test is documented in a test report and on the device. The test intervals depend on the operating conditions of the voltage detector, e.g. frequency of use, environmental conditions and transport. According to German regulations, however, it is advisable to carry out a maintenance test at least every 6 years .		144

3. Verify that the Installation is dead – Voltage Detectors

Design of Voltage Detectors

Voltage detectors according to IEC/EN 61243-1 (DIN VDE 0682-411) are designed to verify on all poles at the work location that the installation is dead according to EN 50110-1 (DIN VDE 0105-100).

Only electrotechnically skilled or instructed persons are allowed to verify on all poles at the work location or as close as possible to the work location that the installation is dead.

Voltage detectors must be tested for correct operation immediately before and after use. Correct operation of voltage detectors without self-testing element must be verified by contacting a part of the installation connected to operating voltage.

Verifying that the installation is dead using a voltage detector is considered live working.

Voltage detectors may only be used for the nominal voltages / nominal voltage ranges as indicated on the rating plate. The user may be at risk if the voltage detector is used for voltages other than indicated on the rating plate (incorrect indication, electric shock, arcing).

Voltage detectors labelled with "For indoor use only" may only be used in indoor installations.

Voltage detectors labelled with "For use in wet weather conditions" may be used in all weather conditions (rain, snow, fog and dew).

Voltage detectors according to IEC/EN 61243-1 (DIN VDE 0682-411) are only suitable to a limited extent for use in **factory assembled (type-tested) installations**. If space in installations is confined, flashover may occur when inserting the test prod into the installation. The user of the voltage detector or the operator of the switchgear installation must contact the manufacturer of the type-tested installation to find out whether the voltage detector may be used in the installation (please refer to the table on the next page: Application of voltage detectors in type-tested, factory assembled switchgear installations).

Design of voltage detectors

Voltage detectors according to IEC/EN 61243-1 (DIN VDE 0682-411) are **single-pole** devices designed to make contact with the part of the installation to be tested.

There are **two mechanically different designs** of voltage detectors: Complete and separate voltage detectors.

Complete voltage detectors (PHE III, PHE and PHG II) consist of an insulating stick, indicator and test prod and are tested as a complete unit.

Separate voltage detectors (PHE III indicator with test prod) must be attached to a suitably rated insulating stick.

Single-pole **voltage detectors** typically consist of a **handle, insulating element, indicator and test prod with contact electrode**.

The **insulating element** is the section of a voltage detector between the hand guard and the red ring. It ensures that the user maintains an adequate safety distance for safe operation.

The **test prod** (contact electrode extension) with a contact electrode **above the red ring** allows to reach remote parts of the installation and to **eliminate** the influence of **interference fields**.

Voltage detectors are classified into two categories based on their behaviour in case of interference fields or their field of application. Voltage detectors of **category "L"** (line) with a short test prod (without contact electrode extension) are designed for use on overhead lines.

Voltage detector of **category "S"** (switchgear) with a long test prod (with contact electrode extension) are resistant to interference fields and are therefore used in switchgear installations. They are also suitable for overhead lines.

The **hand guard** provides a visible barrier between the handle and the insulating element and prevents the user from making contact with the insulating element.

The **red ring** indicates the end of the insulating element in the direction of the test electrode. This provides the user with a visible limit for contact with live parts in the installation. The **insulating element** between the red ring and the hand guard must not contact live parts, however, it may contact earthed parts.

The **test electrode** is the part of the voltage detector that is used to make contact with the part of the installation to be tested.

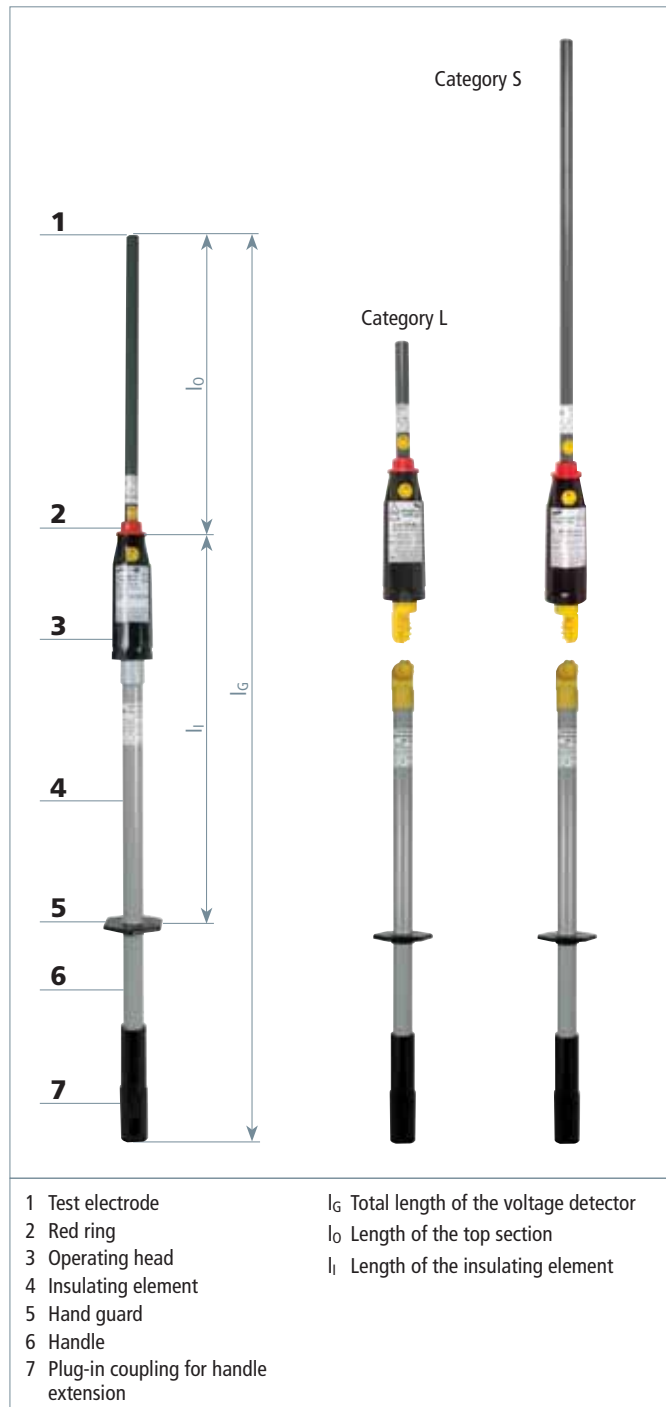

3. Verify that the Installation is dead – Voltage Detectors

Application of Voltage Detectors in factory assembled switchgear installations

Tests carried out in cooperation with switchgear manufacturers have shown that our PHE, PHE III and PHG II voltage detectors (category "S")

can be used in factory assembled switchgear installations (e.g. in accordance with DIN VDE 0670 or EN/IEC 62271-200 (DIN VDE 0671-200)).

Switchgear manufacturer	Type	Nominal voltages U _N	Suitable voltage detectors
ABB	BA/BB systems, BAX systems, BD systems BC systems	10 ... 30 kV	PHE, PHE III and PHG II PHE, PHE III and PHG II
ABB Calor Emag	ZE3/4, ZE7/8, ZK4/5, ZK8 L7.6, ZS1, ZS8 ZW1 Isopond	10 ... 30 kV 10 kV	PHE, PHE III and PHG II PHE and PHE III PHE, PHE III with test probe, Part No. 766 916
AREVA T&D	GS, GSD, GSH, H, K, L	10 ... 20 kV	PHE, PHE III and PHG II
AEG	PI, PIC, PID, PN 300, PN 500, PN 600, PU, PUADC, PUB, PUD, PUDC, SC, SCC, SCD, SCDC, RMB ¹⁾	10 ... 30 kV	PHE, PHE III and PHG II
Concordia			
Sprecher + Schuh			
Sachsenwerk	A (HA, MA, SM), FK (A, B, C, E, F), PIX, R (D1), L, LI, M ¹⁾ , MI ¹⁾ , W (AK, BA, BB, BD, DS), WK (A, B, C, D, E, F, M, T), WZ (K, R, RV)	6 ... 30 kV	PHE, PHE III and PHG II
Starkstromanlagen Dresden	D, WKC-D	10 kV	PHE, PHE III and PHG II
VEB Otto Buchwitz	BSIG, CSIM	20 kV	PHE, PHE III and PHG II
BELUK	BET2308, BET231, BK219, BK216 BMB2, BRS; Compact load-break switch- gear installations	20 kV	PHE, PHE III and PHG II PHE and PHE III
Driescher Moosburg	W12, W24, W36, WEL, F24 E2K, E3K, D12, D24; Compact load-break switchgear installations	12 ... 36 kV 12 ... 24 kV	PHE, PHE III and PHG II PHE, PHE III with great insertion depth (e.g. Part No. 767 731)
Driescher Wegberg	Mipak, Minor, Minex, RKL, ZLDT, TSL, TSLG, FL, SK400, BS600, HS24, LDTC	10 ... 20 kV	PHE, PHE III and PHG II or PHE III with test prod, Part No. 767 767 for type Mipak
Eaton Holec	HC, Unitole Magnefix MMS, SVS, Xiria	3 ... 24 kV 3 ... 15 kV 3 ... 24 kV	PHE and PHE III with electrode, Part No. 766 927 PHE and PHE III with electrode, Part No. 766 915 PHE and PHE III with electrode, Part No. 766 913 or 766 925
Eimers	EKS 10 N, ES 20 N, ES 10 N, EMS 12.190	10 ... 20 kV	PHE, PHE III and PHG II
ORMAZABAL (F & G)	HGKN, EA, MA, KE, EF, WA, K-HGK	10 ... 20 kV	PHE, PHE III and PHG II
Pfisterer	MAG	10 kV	PHE with test prod P2/10
Klöpffer	KMG	10 ... 20 kV	PHE, PHE III and PHG II
Krone	KH10, KHS10d, KHS10dp, KHS17I, KHS17II, KHS20, KHS30 KES10	10 ... 30 kV	PHE, PHE III and PHG II PHE, PHE III with test probe, Part No. 766 916
Miebach	AS, HUK, TE, TSE, DSS, ASR	10 ... 20 kV	PHE, PHE III and PHG II
NATUS	NES, NESCON, NFwZ	3 ... 20 kV	PHE, PHE III and PHG II
Ritter	GT1, GT3	6 ... 30 kV	PHE, PHE III and PHG II
Senteg	AMS12	3 ... 10 kV	PHE, PHE III and PHG II
Siemens	8 BD, 8 CK	6 ... 30 kV	PHE, PHE III with modified contact electrode (on request)
The circuit breaker must be tripped before testing systems containing a circuit breaker	8 BK 20, 8 BJ 20, 8 BK 30, 8 AA 10	6 ... 20 kV	PHE, PHE III and PHG II
Wickmann	DZ-Schaltschrank	20 kV	PHE, PHE III and PHG II
Ziegler	AZ-Zellen	10 ... 20 kV	PHE, PHE III and PHG II

¹⁾ Switchgear panels with integrated division into busbar or cable compartments require special guide adapters for the fixed isolating contacts.

3. Verify that the Installation is dead – Voltage Detectors

PHE III Voltage Detector



PHE III voltage detector with visual and acoustic indicator used for an indoor switchgear installation

Nominal Voltages up to 30 kV / 50 Hz

Safe verification of isolation from supply voltage

- Reliable indication
- Easy to use
- Cost-effective / space-saving transport

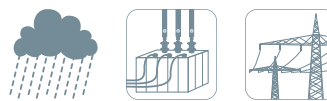

General Information:

Standard	EN/IEC 61243-1 (DIN VDE 0682-411)
Temperature range	-25 °C ... +55 °C, climatic category N
Design	Complete
For use in wet weather conditions	
For	Indoor and outdoor installations
Indication	Acoustic and visual
Self-testing element	Yes
Material (test electrode)	Copper alloy/gal Sn
Material (test prod)	Glass-fibre reinforced epoxy resin tube
Material (indicator)	Plastic, fully insulated
Material (insulating stick)	Glass-fibre reinforced polyester tube



Testing with integrated electrode



Testing with screwed-on V-shaped electrode

Nominal Voltages up to 30 kV / 50 Hz, M12 Thread

Category "S" for switchgear installations and overhead lines.

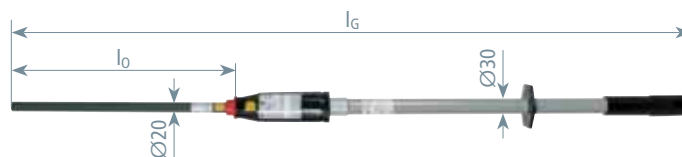

Type PHE3 ...	3 S	6 S	10 S	20 S	30 S
Part No.	767 703	767 706	767 710	767 720	767 730
Nominal voltage (U _N)	3 kV	6 kV	10 kV	20 kV	30 kV
Total length (l _G)	1080 mm	1080 mm	1080 mm	1230 mm	1415 mm
Insertion depth (l _o)	285 mm	285 mm	285 mm	435 mm	620 mm

Type PHE3 ...	3.3 S SN7130	6.6 S SN7101	11 S SN7116	22 S SN7128	33 S SN7129
Part No.	767 798	767 707	767 719	767 756	767 757
Nominal voltage (U _N)	3.3 kV	6.6 kV	11 kV	22 kV	33 kV
Total length (l _G)	1080 mm	1080 mm	1080 mm	1230 mm	1415 mm
Insertion depth (l _o)	285 mm	285 mm	285 mm	435 mm	620 mm

Nominal Voltage Ranges up to 30 kV / 50 Hz, M12 Thread

Category "S" for switchgear installations and overhead lines.

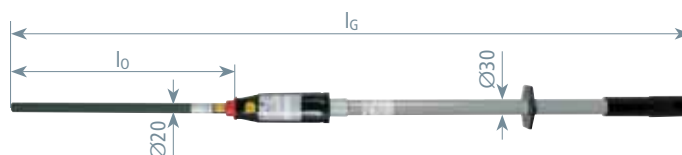

Type PHE3 ...	3 10 S	6 20 S	10 30 S
Part No.	767 711	767 721	767 731
Nominal voltage (U _N)	3 ... 10 kV	6 ... 20 kV	10 ... 30 kV
Total length (l _G)	1415 mm	1575 mm	1675 mm
Insertion depth (l _o)	620 mm	780 mm	880 mm

Type PHE3 ...	3.3 11 S SN7127	6.6 22 SN7197	11 33 S SN7264
Part No.	767 758	767 769	767 773
Nominal voltage (U _N)	3.3 ... 11 kV	6.6 ... 22 kV	11 ... 33 kV
Total length (l _G)	1415 mm	1575 mm	1675 mm
Insertion depth (l _o)	620 mm	780 mm	880 mm

3. Verify that the Installation is dead – Voltage Detectors

Nominal Voltages up to 25 kV / 50 Hz

For the overhead contact lines of electric railways.
Category "S" for single-ended monophasic systems.

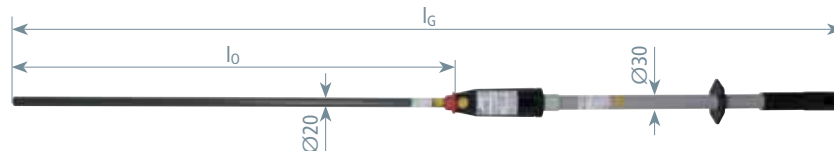

Type PHE3 ...	25 S 50 1P
Part No.	767 125
Nominal voltage (U _N)	25 kV
Total length (l _G)	1680 mm
Insertion depth (l ₀)	880 mm



Nominal Voltages up to 30 kV / 50 kV, Gear Coupling

Category "S" for switchgear installations and overhead lines.

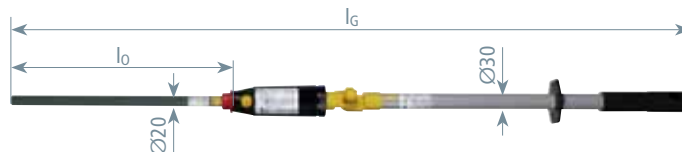

Type PHE3 ...	3 S ZK	6 S ZK	10 S ZK
Part No.	767 903	767 906	767 910
Nominal voltage (U _N)	3 kV	6 kV	10 kV
Total length (l _G)	1150 mm	1150 mm	1150 mm
Insertion depth (l ₀)	285 mm	285 mm	285 mm

Type PHE3 ...	20 S ZK	30 S ZK
Part No.	767 920	767 930
Nominal voltage (U _N)	20 kV	30 kV
Total length (l _G)	1300 mm	1485 mm
Insertion depth (l ₀)	435 mm	620 mm

Nominal Voltage Ranges up to 30 kV / 50 Hz, Gear Coupling

Category "S"

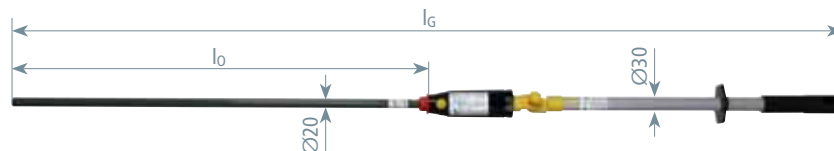

Type PHE3 ...	3 10 S ZK	6 20 S ZK	10 30 S ZK
Part No.	767 941	767 951	767 961
Nominal voltage (U _N)	3 ... 10 kV	6 ... 20 kV	10 ... 30 kV
Total length (l _G)	1485 mm	1645 mm	1745 mm
Insertion depth (l ₀)	620 mm	780 mm	880 mm

Nominal Voltage Ranges up to 30 kV / 50 Hz, switchable, M12 Thread

The nominal voltage selector switch allows to switch between two nominal voltage ranges. For safety reasons, the voltage detector can only be switched on if the selector switch is switched to the most sensitive range of 3 kV to 10 kV or 3.3 kV to 11 kV. The switch snaps into the relevant position, thus providing protection against inadvertent switching. A magnetically operated, wear-resistant reed switch changes the switching position.

Category "S" for switchgear installations and overhead lines.

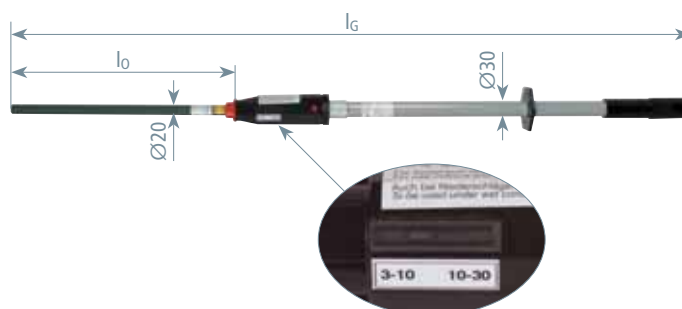

Type PHE3 ...	U 3 30 S	U 3.3 33 SN7108
Part No.	767 733	767 774
Nominal voltage (U _N)	3 ... 10 / 10 ... 30 kV	3.3 ... 11 / 11 ... 33 kV
Total length (l _G)	1675 mm	1675 mm
Insertion depth (l ₀)	880 mm	880 mm

3. Verify that the Installation is dead – Voltage Detectors

Nominal Voltage Ranges up to 36 kV / 50 Hz, switchable, Gear Coupling

The nominal voltage selector switch allows to switch between two nominal voltage ranges. For safety reasons, the voltage detector can only be switched on if the selector switch is switched to the most sensitive range of (3 kV to 10 kV or 6 kV to 20 kV). The switch snaps into the relevant position, thus providing protection against inadvertent switching. A magnetically operated, wear-resistant reed switch changes the switching position.

Category "S" for switchgear installations and overhead lines.

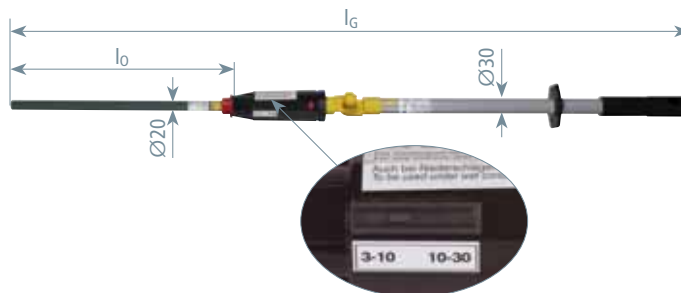

Type PHE3 ...	U 3 30 S ZK	U 6 36 S SN7728
Part No.	767 960	767 944
Nominal voltage (U _N)	3 ... 10 / 10 ... 30 kV	6 ... 20 / 20 ... 36 kV
Total length (l _G)	1745 mm	1745 mm
Insertion depth (l _o)	880 mm	880 mm

Nominal Voltage Ranges up to 30 kV / 50 Hz, Test Kit, M12 Thread

With two test prods of Category "S" for switchgear installations and overhead lines and of Category "L" for overhead lines.

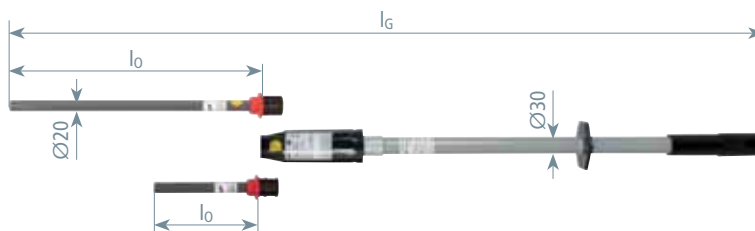

Type PHE3 ...	6 20 SL	10 30 SL
Part No.	767 740	767 750
Nominal voltage (U _N)	6 ... 20 kV	10 ... 30 kV
Total length (l _G)	1575 / 980 mm	1675 / 980 mm
Insertion depth (l _o)	780 / 185 mm	880 / 185 mm

Nominal Voltage Ranges up to 30 kV / 50 Hz, Test Kit, Gear Coupling

With two test prods of Category "S" for switchgear installations and overhead lines and of Category "L" for overhead lines.

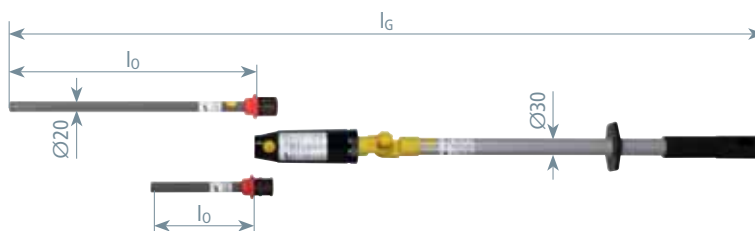

Type PHE3 ...	6 20 SL ZK	10 30 SL ZK
Part No.	767 940	767 950
Nominal voltage (U _N)	6 ... 20 kV	10 ... 30 kV
Total length (l _G)	1650 / 1050 mm	1750 / 1050 mm
Insertion depth (l _o)	780 / 185 mm	880 / 185 mm

3. Verify that the Installation is dead – Voltage Detectors

PHE III ZK Indicator with Test Prod

Nominal Voltages up to 30 kV / 50 Hz

Safe verification of isolation from supply voltage

- Reliable indication with standby function
- Easy to use
- Cost-effective / space-saving transport



General Information:	
Standard (indicator with test prod)	EN/IEC 61243-1 (DIN VDE 0682-411)
Standard (universal gear coupling)	EN/IEC 60832 (DIN VDE 0682-211)
Temperature range	-25 °C ... +55 °C, climatic category N
Design	Separate
For use in wet weather conditions	
For	Indoor and outdoor installations
Indication	Acoustic and visual
Self-testing element	Yes
Material (test electrode)	Copper alloy/gal Sn
Material (test prod)	Glass-fibre reinforced epoxy resin tube
Material (indicator)	Plastic, fully insulated



PHE III indicator with test prod, universal gear coupling and insulating stick

Standby function

The PHE III indicator with test prod has a standby function meaning that the device is automatically activated as soon as contact with energised equipment is made (without previous self-test) and visually and acoustically indicates "voltage present". When making contact with de-energised equipment, the indicator is not activated.

Attention

The PHE III indicator with test prod may only be used in combination with a suitably rated insulating stick.

Nominal Voltage Ranges up to 30 kV / 50 Hz, Category "S"

Category "S" for switchgear installations and overhead lines.

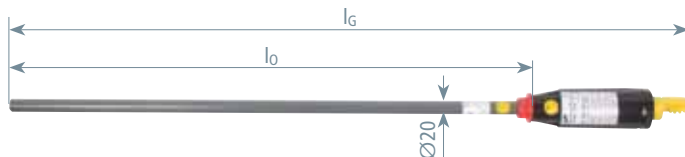

Type PHE3 ...	PK6 20 S SB ZK	PK10 30 S SB ZK
Part No.	767 921	767 931
Nominal voltage (U _N)	6 ... 20 kV	10 ... 30 kV
Total length (l _G)	1010 mm	1110 mm
Insertion depth (l _o)	780 mm	880 mm

Nominal Voltage Ranges up to 30 kV / 50 Hz, Category "L"

Category "L" for overhead lines.

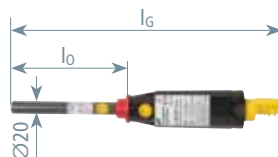

Type PHE3 ...	PK6 20 L SB ZK	PK10 30 L SB ZK
Part No.	767 922	767 932
Nominal voltage (U _N)	6 ... 20 kV	10 ... 30 kV
Total length (l _G)	415 mm	415 mm
Insertion depth (l _o)	185 mm	185 mm

3. Verify that the Installation is dead – Voltage Detectors

Accessories for PHE III ZK Indicator with Test Prod

Telescopic Insulating Stick, with universal Gear Coupling

With scale for measuring the ground clearance, mounted support included.



Type	ISMTC N 36 ZK 10600
Part No.	766 037
Nominal voltage (U _N)	Up to 36 kV
Total length (l _G max / l _G min)	10,600 / 1750 mm
Material	Glass-fibre reinforced epoxy resin tube

For PHE III, with universal Gear Coupling

Handle end fitting with plastic plug-in coupling as extension handle.

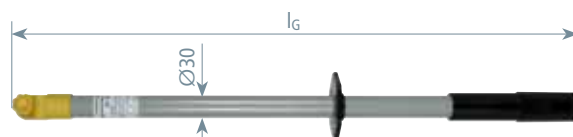

Type	IS ZK STK 670
Part No.	766 368
Diameter (U _N)	30 kV
Total length (l _G)	670 mm
Length (handle) (l _H)	265 mm
Material	Glass-fibre reinforced polyester tube

PHE III Voltage Detector Kit



PHE III voltage detector used on a 110 kV outdoor station

Nominal Voltage 10 ... 132 kV / 50 Hz

Safe verification of isolation from supply voltage

- Reliable indication
- Easy to use
- Multi-purpose kit
- Cost-effective / space-saving transport



General Information:	
Standard	EN/IEC 61243-1 (DIN VDE 0682-411)
Temperature range	-25 °C ... +55 °C, climatic category N
Design	Complete
For use in wet weather conditions	
For	Indoor and outdoor installations
Indication	Acoustic and visual
Self-testing element	Yes
Material (test electrode)	Copper alloy/gal Sn
Material (test prod)	Glass-fibre reinforced epoxy resin tube
Material (indicator)	Plastic, fully insulated
Material (insulating stick)	Glass-fibre reinforced polyester tube

3. Verify that the Installation is dead – Voltage Detectors

Nominal Voltage 20 kV / 50 Hz, Category "S"

Category "S" for switchgear installations and overhead lines.

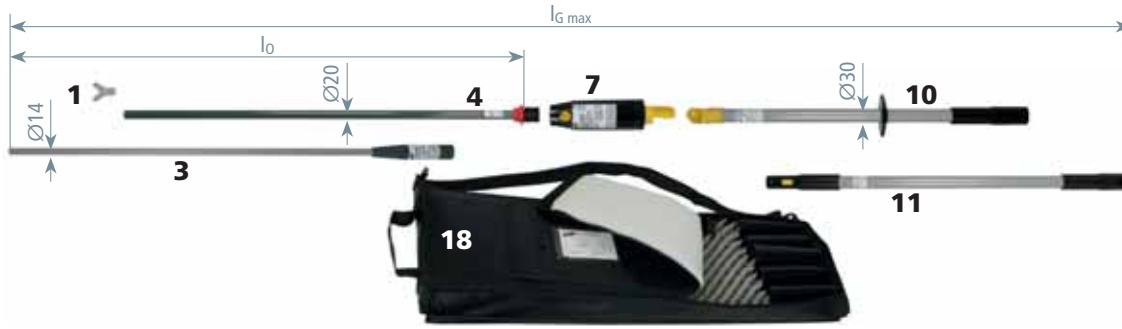

Parts list:			
Pos.	Part No.	Pos.	Part No.
1	766 927	11	766 335
2	766 924	12	766 115
3	766 960	13	766 116
4	767 763	14	766 117
5	767 771	15	766 120
6	769 701	16	766 077
7	767 722	17	766 889
8	767 734	18	767 996
9	769 713	19	766 998
10	766 368		

For more detailed information on these products, see Accessories chapter.

Type	PHE3S 20 S ZK
Part No.	767 724
Nominal voltage (UN)	20 kV
Total length (lG max)	3080 mm
Insertion depth (l0 max)	1580 mm

Possible lengths:		
Length lG	Insertion depth l0	Pos. No.
3080 mm	1580 mm	3+4+7+10+11
2290 mm	800 mm	1+4+7+10+11
1660 mm	800 mm	1+4+7+10

Nominal Voltage Range 60 ... 110 kV / 50 Hz, Category "S"

Category "S" for switchgear installations and overhead lines.

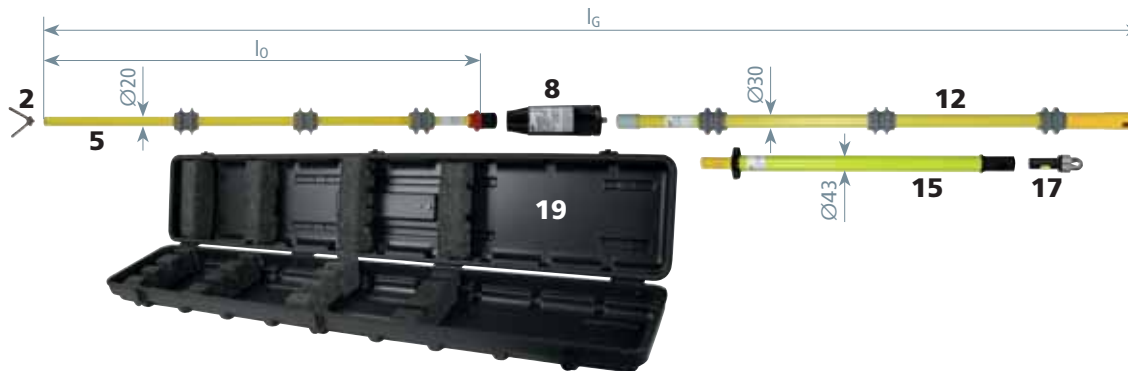

Type	PHE3S2 60 110 S
Part No.	767 980
Nominal voltage (UN)	60 ... 110 kV
Total length (lG)	2980 mm
Insertion depth (l0)	880 mm

Kit includes:		
Type	Part No.	Pos. No.
PHE3 60 110 S	767 990	2+5+8+12+15+17
KKL PHE3 60 110	766 998	19

Nominal Voltage Range 60 ... 110 kV / 50 Hz, Category "S", CODED

Special test prod and indicator are mutually coded, i.e. no other test prod fits mechanically for the used indicator. Thus confusion of test prods is avoided.

Category "S" for switchgear installations and overhead lines as coded type.

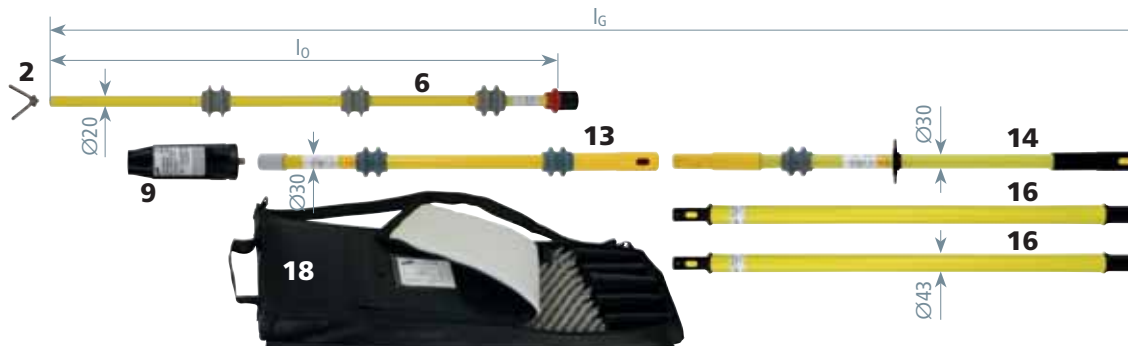

Type	PHE3S60 110S CSN7774
Part No.	769 712 ^{NEW}
Nominal voltage (UN)	60 ... 110 kV
Total length (lG max / lG min)	4790 / 2840 mm
Insertion depth (l0)	880 mm

Kit includes:		
Type	Part No.	Pos. No.
PHE360 110SITCSN7773	767 710	2+6+9+13+14+(2x) 16
KKL PHE3 60 110	767 996	18

3. Verify that the Installation is dead – Voltage Detectors

PHE Voltage Detector



PHE voltage detector with visual indication

Nominal Voltages up to 30 kV / 50 Hz

Easy and safe testing

- Reliable indication
- Easy to use

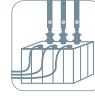

General Information:

Standard	EN/IEC 61243-1 (DIN VDE 0682-411) and E DIN VDE 0682-421
Temperature range	-25 °C ... +55 °C, climatic category N
Design	Complete
For use in wet weather conditions	
For	Indoor and outdoor installations
Indication	Visual
Self-testing element	Yes
Material (test electrode)	Copper alloy/gal Sn
Material (test prod)	Glass-fibre reinforced epoxy resin tube
Material (indicator)	Plastic, fully insulated
Material (insulating stick)	Glass-fibre reinforced polyester tube

Nominal Voltages up to 30 kV / 50 Hz

Category "S" for switchgear and overhead lines.

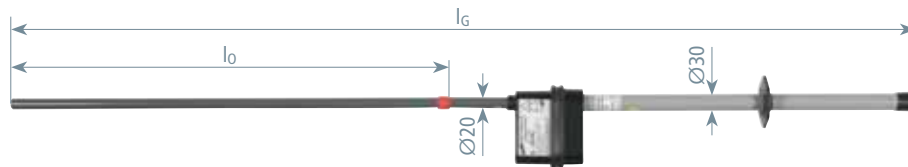

General technical data:						
Frequenz	50 Hz					
Type PHE ...	3 S	6 S	10 S	20 S	30 S	
Part No.	767 403	767 406	767 418	767 428	767 438	
Nominal voltage (U _N)	3 kV	6 kV	10 kV	20 kV	30 kV	
Total length (l _G)	1115 mm	1115 mm	1115 mm	1300 mm	1460 mm	
Insertion depth (l ₀)	320 mm	320 mm	320 mm	505 mm	670 mm	
Type PHE ...	3 10 S		6 20 S		15 30 S	
Part No.	767 410		767 420		767 430	
Nominal voltage (U _N)	3 ... 10 kV		6 ... 20 kV		15 ... 30 kV	
Total length (l _G)	1375 mm		1565 mm		1565 mm	
Insertion depth (l ₀)	580 mm		770 mm		770 mm	

Nominal Voltage Ranges up to 30 kV / 50 Hz, switchable

The nominal voltage selector switch allows to switch between three voltage ranges. For safety reasons, the voltage detector can only be switched on if the selector switch is switched to the most sensitive range of 3 kV to 10 kV. The switch snaps into the relevant position and provides protection against inadvertent switching. A magnetically operated, wear-resistant reed switch changes the switching position.

Category "S" for switchgear and overhead lines.

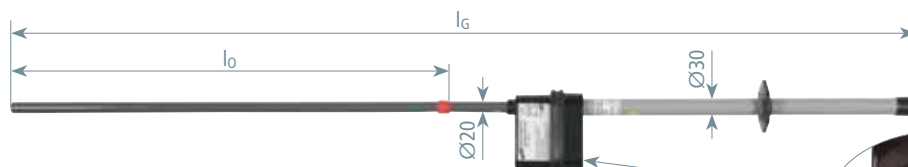

Type PHE ...	U 3 30 S
Part No.	767 433
Nominal voltage (U _N)	3 ... 10 / 6 ... 20 / 15 ... 30 kV
Frequency	50 Hz
Total length (l _G)	1565 mm
Insertion depth (l ₀)	770 mm



3. Verify that the Installation is dead – Voltage Detectors

Nominal Voltage Ranges 20 kV / 50 Hz or 16.7 Hz, switchable

For three-phase systems and single-ended monophas switchgear installations.

Special features of the switchable voltage detector:

The selector switch can be moved into three positions for the relevant voltage and frequency ranges:

3 ... 10 kV / 50 Hz – three-phase current

6 ... 20 kV / 50 Hz – three-phase current

6 ... 20 kV / 16.7 Hz – single-ended monophas systems

For safety reasons, the detector can only be switched on if the selector switch is switched to the most sensitive range of 3 kV to 10 kV / 50 Hz. The switch snaps into the relevant position and provides protection against accidental switching. A magnetically operated, wear-resistant reed switch changes the switching position.

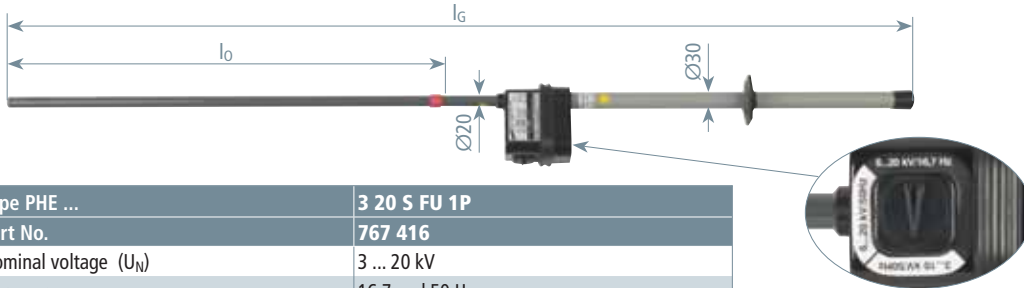

Type PHE ...	3 20 S FU 1P
Part No.	767 416
Nominal voltage (U _N)	3 ... 20 kV
Frequency	16.7 and 50 Hz
Total length (l _G)	1560 mm
Insertion depth (l _o)	770 mm
DB drawing No.	3 Ebgw 02.54
DB material No.	743 361



Nominal Voltage Ranges up to 20 kV / 16.7 Hz

For single-ended monophas switchgear installations and point heating systems.

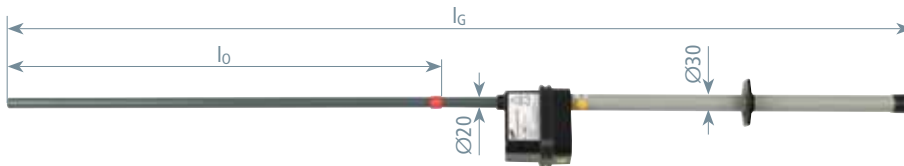

Type PHE ...	6 20 S 16.7 1P
Part No.	767 415
Nominal voltage (U _N)	6 ... 20 kV
Frequency	16.7 Hz
Total length (l _G)	1560 mm
Insertion depth (l _o)	770 mm



Nominal Voltage 15 kV / 16.7 Hz

For traction power lines.

Hook-shaped electrode and end fitting with plug-in coupling and non-slip eye included.

Use for traction power lines

Voltage detectors for traction power lines have a shorter extension than voltage detectors for overhead contact lines. To ensure reliable indication, the PHE 15 16.7 BEL STK voltage detector may only be used for traction power lines and not for other components of overhead contact lines. Moreover, it must not be used from ladder trolleys for overhead contact lines.

Traction power lines are supply lines, line feeders, bypass lines, connecting lines, feeder lines, 15 kV cables, cable sealing ends, switch lines and transverse switch lines.

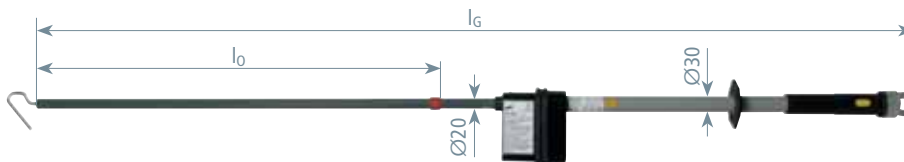

Type PHE ...	15 16.7 BEL STK
Part No.	767 413
Nominal voltage (U _N)	15 kV
Frequency	16.7 Hz
Total length (l _G)	1645 mm
Insertion depth (l _o)	765 mm



3. Verify that the Installation is dead – Voltage Detectors

PHE Voltage Detector Kit



Nominal Voltage 15 kV / 16.7 Hz

Easy and safe testing

- For overhead contact lines of electric railways
- Cost-effective / space-saving transport
- Easy to use due to simple plug-in system

Parts list:

Pos.	Part No.	Pos.	Part No.
1	766 619	7	766 076
2	766 678	8	766 077
3	766 677	9	766 889
4	766 072	10	766 602
5	766 075	11	766 704
6	766 073		

For more detailed information on these products, see Accessories chapter.



General Information:

Standard	DIN VDE 0681-6
For use in wet weather conditions	
Anzeige	Visual
Self-testing element	Yes
Material (test electrode)	St/gal Zn
Material (test prod)	Glass-fibre reinforced polyester tube
Material (indicator)	Plastic, fully insulated
Material (insulating stick)	Glass-fibre reinforced polyester tube

PHE voltage detector with visual indicator used on an overhead contact line of German Railways (DB)

Nominal Voltage 15 kV / 16.7 Hz

Detachable (four elements).

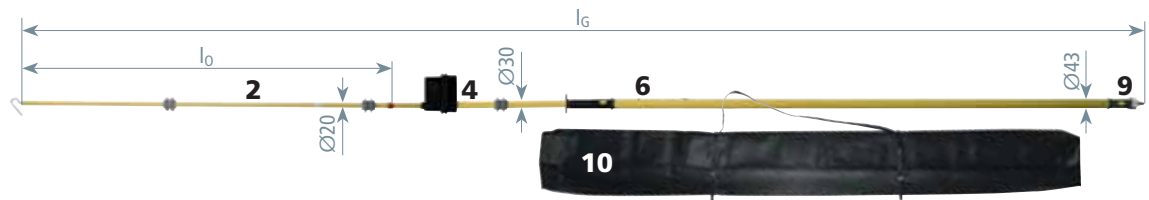

Type PHE 15 16.7 ...	4T TA
Part No.	766 616
Nominal voltage (U _N)	15 kV
Frequency	16.7 Hz
Total length (l _G)	4890 mm
Insertion depth (l ₀)	1675 mm
DB drawing No.	3 Ebgw 02.51
DB material No.	237 129

Nominal Voltage 15 kV / 16.7 Hz (for Transport in Motor Vehicles)

Detachable (six elements).

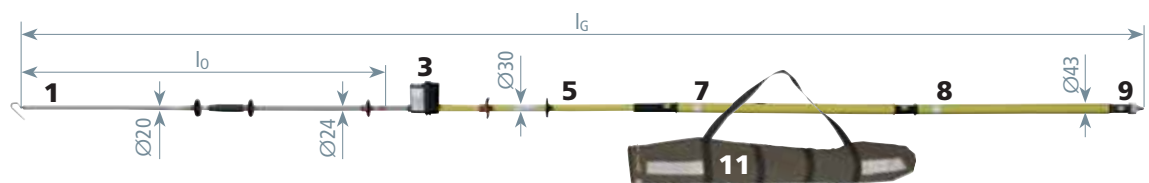

Type PHE 15 16.7 ...	6T TA
Part No.	766 617
Nominal voltage (U _N)	15 kV
Frequency	16.7 Hz
Total length (l _G)	4900 mm
Insertion depth (l ₀)	1675 mm
DB drawing No.	3 Ebgw 02.53
DB material No.	652 975



Two-part test prod with robust threaded coupling (six-part kit for transport in motor vehicles)

3. Verify that the Installation is dead – Voltage Detectors

ASP Non-Contact Voltage Detector Kit

Nominal Voltage Range 110 ... 420 kV / 16.7 and 50 Hz

Easy and safe testing

- Easy to use due to compact design
- Cost-effective / space-saving transport

Parts list:			
Pos.	Part No.	Pos.	Part No.
1	767 576	6	767 564
2	767 577	7	766 369
3	767 591	8	767 574
4	767 592	9	767 996
5	767 593		

For more detailed information on these products, see Accessories chapter.



General Information:	
Temperature range	-25 °C ... +55 °C
For use in wet weather conditions	
For	Overhead lines and outdoor switching stations
Indication	Acoustic and visual
Self-testing element	Yes
Material (indicator)	Plastic, fully insulated, black
Material (electric field sensor)	Plastic, black
Material (insulating stick)	Glass-fibre reinforced polyester tube



Use of an ASP distance voltage detector in an outdoor switching station

Category "S" and "L"

Devices of category "S" may only be used in outdoor switching stations, devices of category "L" for overhead lines only. Devices of category "S" / "L" may be used both for outdoor switching stations and overhead lines.

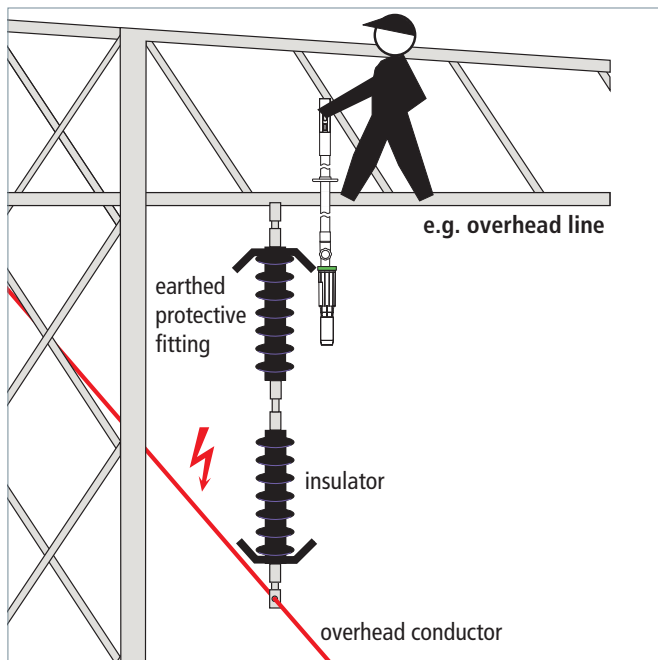

Use for overhead lines

The green ring on the ASP distance voltage detector with category "L" electric field sensor is used to make contact with the last earthed protective fitting in such a way that the electric field sensor points in the direction of the overhead conductor fixed at the other end of the insulator.

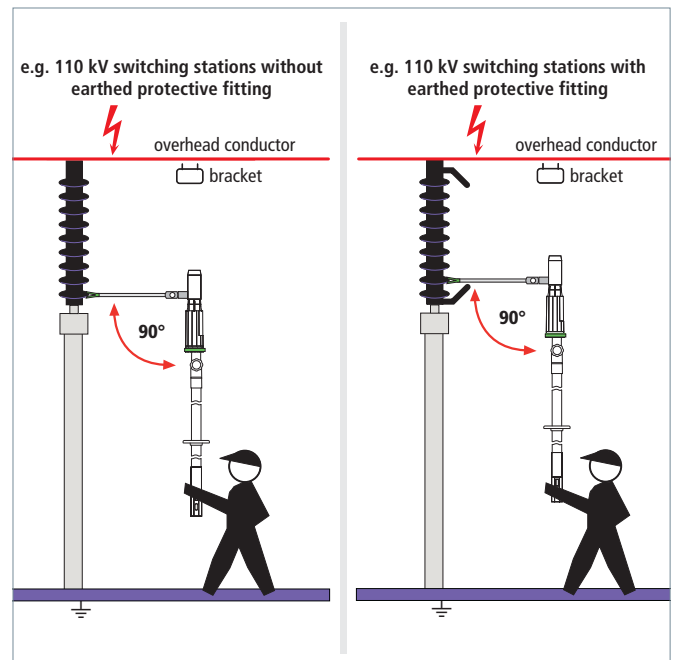

Use in outdoor switching stations

The green ring on the arm of the ASP distance voltage detector with category "S" electric field sensor is used to make contact with the lowest insulator plate at a right angle. If an earthed protective fitting is available, contact is made at the next possible insulator plate above the protective fitting.

3. Verify that the Installation is dead – Voltage Detectors

Category "L", 50 Hz

Category "L" for overhead lines in accordance with the DIN VDE V 0682-417/10.2013 preliminary standard.

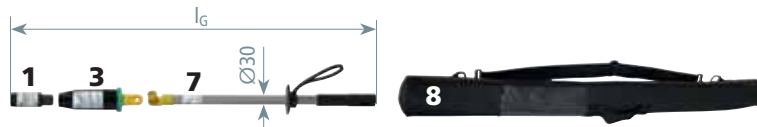

Type ASPS 110 ...	420 L
Part No.	767 571
Nominal voltage (U _N)	110 ... 420 kV
Frequency	50 Hz
Total length (l _G)	960 mm

Kit includes:		
Type	Part No.	Pos. No.
ASP 110 420 L	767 581	1+3+7
KLT 104 9	767 574	8

Category "L", 16.7 Hz

Category "L" for centre-earthed monophas traction power lines.

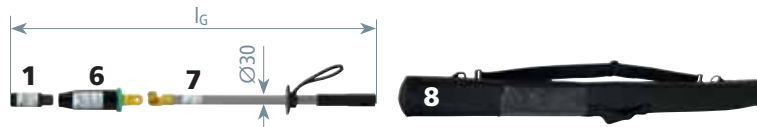

Type ASPS 110 ...	132 16.7 L
Part No.	767 565
Nominal voltage (U _N)	110 ... 132 kV
Frequency	16.7 Hz
Total length (l _G)	960 mm
DB drawing No.	3 Eku 710 002

Kit includes:		
Type	Part No.	Pos. No.
ASP 110 132 16.7 L	767 585	1+6+7
KLT 104 9	767 574	8

Category "S", 50 Hz

Category "S" for outdoor switching stations.



Type ASPS 110 ...	420 S
Part No.	767 572
Nominal voltage (U _N)	110 ... 420 kV
Frequency	50 Hz
Total length (l _G)	1000 mm

Kit includes:		
Type	Part No.	Pos. No.
ASP 110 420 S	767 582	2+4+7
KLT 104 9	767 574	8

Category "S / L", 50 Hz

Category "S/L" for overhead lines and outdoor switching stations.

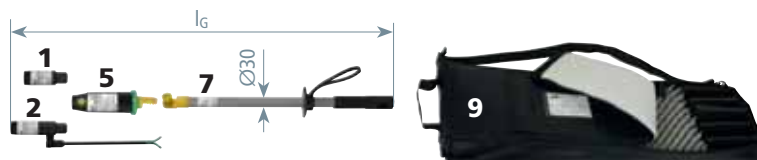

Type ASPS 110 ...	420 S L
Part No.	767 573
Nominal voltage (U _N)	110 ... 420 kV
Frequency	50 Hz
Total length (l _G)	1000 mm

Kit includes:		
Type	Part No.	Pos. No.
ASP 110 420 S L	767 583	1+2+5+7
KLT 101 30 10	767 996	9

3. Verify that the Installation is dead – Voltage Detectors

HSA 194 High-Voltage Indicator

Nominal Voltage Range 110 ... 420 kV / 16.7 and 50 Hz

Easy and safe testing

- For contactlessly verifying that switchgear and high-voltage overhead lines or centre-earthed mono-phase traction power lines are dead
- Cost-effective / space-saving transport

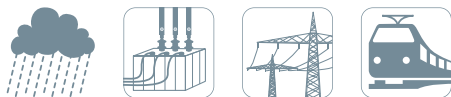

General Information:

Temperature range	- 25 °C ... + 55 °C, climatic category N
For use in wet weather conditions	
Indication	Acoustic and visual
Self-testing element	Yes
Material (insulating stick)	Glass-fibre reinforced polyester tube



High-voltage indicator used on a 110 kV overhead line.

Application notes

The high-voltage indicator is used to verify from the crossarm of the overhead line tower that the traction powerline is dead.

The green ring on the HSA 194 is used to make contact with the last earthed protective fitting (or earthed insulator cap) so that the measuring head of the voltage detector points in the direction of the overhead conductor fixed at the other end of the insulator (stick axis of the HSA 194 parallel to the longitudinal axis of the insulator). "Voltage present" is indicated visually (red flashing light) and acoustically (audible signal).

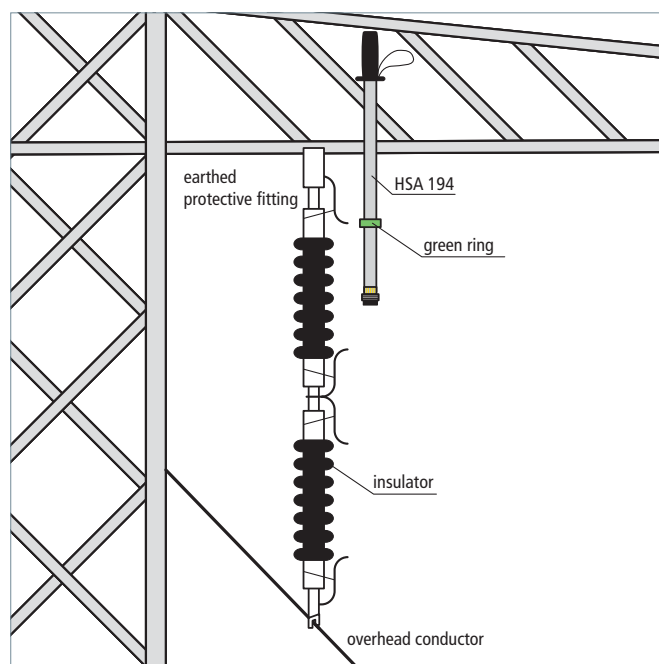

Nominal Voltage Range 110 ... 420 kV

With plug-in coupling as end fitting for extending the handle.
Storage bag included in delivery.

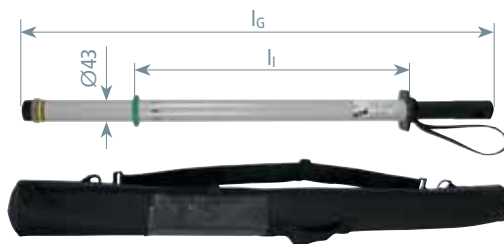

Type HSA194 110 420 ...	STK	16.7
Part No.	767 541	767 542
Nominal voltage range (U _N)	110 ... 420 kV	110 ... 420 kV
Frequency	50 Hz	16.7 Hz
Total length (l _G)	940 mm	940 mm
Insulating clearance (l _I)	540 mm	540 mm
DB drawing No.	—	3 Ekgw 02.54



3. Verify that the Installation is dead – Voltage Detectors

HSA 205 High-Voltage Indicator



HSA 205 high-voltage indicator with insulating cap used on a switchgear installation.

Nominal Voltage Range 1 ... 420 kV / 50 Hz

- For contactlessly verifying that switchgear installations and high-voltage overhead lines are dead
- Wide nominal voltage range

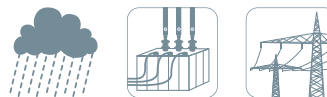

General Information:

Temperature range	-25 °C ... +55 °C, climatic category N
For use in wet weather conditions	
Indication	Visual and acoustic
Self-testing element	Yes
Material (insulating stick)	Glass-fibre reinforced polyester tube

Application notes

The operating head of HSA 205 high-voltage indicator is fitted with a yellow switching ring, which is used to set the required nominal voltage range, either 1 to 30 kV, 30 to 220 kV or 110 to 420 kV.

The transparent insulating cap must be used in the voltage range from 1 to 30 kV. Provided that the insulating tube and cap of the high-voltage indicator are in a dry and clean condition, the minimum distance A can be reduced for nominal voltages up to 30 kV.

If these conditions cannot be ensured, the minimum distance A must be maintained!

Minimum distances A according to nominal voltage:

Selected voltage range	Nominal voltage acc. to DIN VDE 0105 Part 1	Min. safety distance A DIN VDE 0105 Part 1
Red 1 ... 30 kV	1 up to 6 kV	90 mm indoor installations
	6 up to 10 kV	120 mm indoor installations
	1 up to 10 kV	150 mm outdoor installations
	10 up to 20 kV	220 mm indoor and outdoor installations
	20 up to 30 kV	320 mm indoor and outdoor installations
White 30 ... 220 kV	30 up to 45 kV	480 mm indoor and outdoor installations
	45 up to 60 kV	630 mm indoor and outdoor installations
	60 up to 110 kV	1100 mm indoor and outdoor installations
Yellow 110 ... 420 kV	110 up to 220 kV	2100 mm indoor and outdoor installations
	220 up to 420 kV	2900/3400 mm indoor and outdoor installations

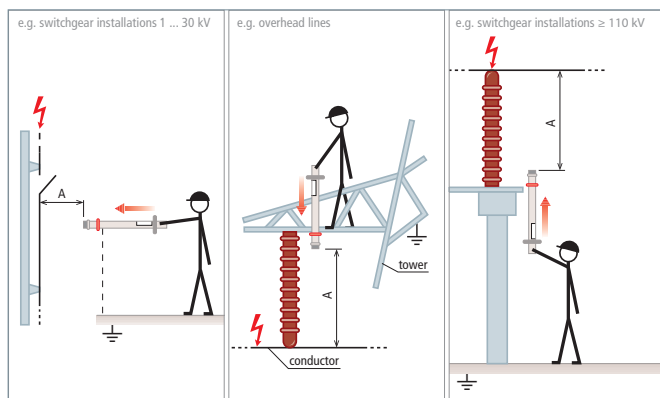

Nominal Voltage Ranges up to 420 kV, switchable

With insulating cap and plug-in coupling as end fitting for extending the handle.
Storage bag included in delivery.

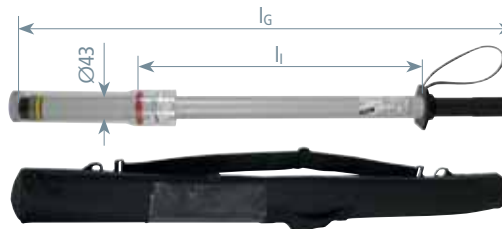

Type	HSA205 U 1 420 STK
Part No.	767 552
Nominal voltage range (U _N)	1 ... 30 / 30 ... 220 / 110 ... 420 kV
Frequency	50 Hz
Total length (l _G)	950 mm
Insulating clearance (l _I)	540 mm

3. Verify that the Installation is dead – Voltage Detectors

PHG II Voltage Detector

Nominal Voltages up to 20 kV / 50 Hz

Easy and safe testing

- Cost-effective
- Reliable indication



General Information:	
Standard	EN/IEC 61243-1 (DIN VDE 0682-411)
Temperature range	-25 °C ... +55 °C, climatic category N
Design	Complete
Not suitable for use in wet weather conditions	☀
For	Indoor installations
Indication	Visual, 3 LEDs
Function	Passive voltage detector without batteries
Material (test electrode)	Cu/gal Sn
Material (test prod)	Glass-fibre reinforced polyester tube
Material (indicator)	Plastic
Material (insulating stick)	Glass-fibre reinforced polyester tube



PHG II voltage detector used in a type-tested switchgear installation

Test for correct operation

The EN 50110-1 (DIN VDE 0105-100) standard requires that voltage detectors be tested for correct operation directly before and after they are used. Voltage detectors without self-testing element must be tested for correct operation by contacting parts of the installation connected to operating voltage.

A fork-shaped electrode is situated on the test prod of the voltage detector.

Nominal Voltages up to 20 kV / 50 Hz

Category "S" for indoor switchgear installations.

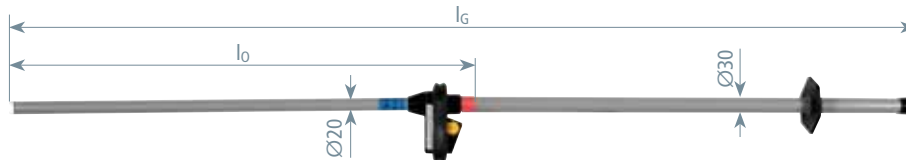

Type PHG2 ...	6	10	20
Part No.	766 706	766 710	766 720
Nominal voltage (U _N)	6 kV	10 kV	20 kV
Total length (l _G)	1425 mm	1425 mm	1425 mm
Insertion depth (l ₀)	720 mm	720 mm	720 mm

3. Verify that the Installation is dead – Voltage Detectors

PHE/G d.c. Voltage Detector



PHE/G II d.c. voltage detector for d.c. links (ICE power car)

Nominal Voltages up to 24 kV d.c.

Safe verification of isolation from supply voltage

- For use in direct voltage systems (electrified rail networks, d.c. links)
- Reliable indication
- Easy to use due to compact design
- User-friendly



The test prod of d.c. voltage detectors is colour-coded according to the polarity of the test prod:

positive pole – red;

negative pole – blue.

General Information:

Standard	Based on EN/IEC 61243-2 (DIN VDE 0682-412)
Temperature range	-25 °C ... +55 °C, climatic category N
For use in wet weather conditions	
For	Indoor and outdoor installations
Indication	Visual
Self-testing element	Yes
Material (test prod)	Glass-fibre reinforced polyester tube
Material (indicator)	Plastic, fully insulated
Material (insulating stick)	Glass-fibre reinforced polyester tube
Material (earthing / connecting cable)	Copper cable, highly flexible



Earth clamp with adjustable handle and magnet



PHE/G I for Overhead Contact Lines, positive Pole on Indicator with Test Prod

One stick (four elements)

- For direct voltage systems with earthed negative pole
- Positive pole: Indicator with test prod
- Negative pole: Earth clamp

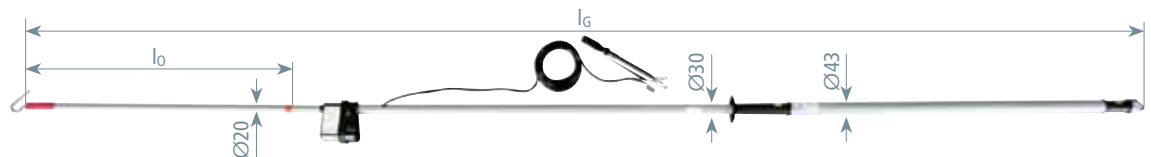

Type	PHEG1.FD P SN7647	PHEG1.FD P SN7544
Part No.	767 656	767 652
Threshold voltage (U _t)	300 V	750 V
Nominal voltage (U _N)	600 ... 750 V	1.5 kV
Length (earthing cable)	6000 mm	6000 mm
Total length (l _G)	4125 mm	4125 mm
Insertion depth (l ₀)	1015 mm	1015 mm

3. Verify that the Installation is dead – Voltage Detectors

PHE/G I for Switchgear Installations, positive Pole on Indicator with Test Prod

One stick

- For direct voltage systems with earthed negative pole
- Positive pole: Indicator with test prod
- Negative pole: Earth clamp

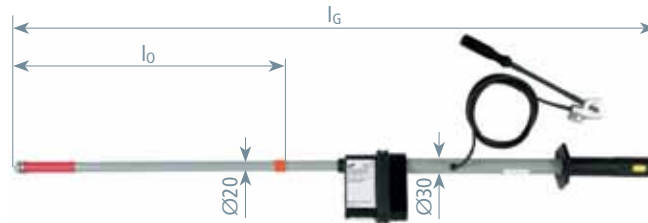

Type	PHEG1.S P SN7401
Part No.	767 666
Threshold voltage (U _t)	120 V
Nominal voltage (U _N)	1 ... 24 kV
Length (earthing cable)	2000 mm
Total length (l _G)	1260 mm
Insertion depth (l ₀)	535 mm

PHE/G II for Switchgear Installations

Two sticks

- For unearthed direct voltage installations
- For d.c. links
- Positive pole: Indicator with test prod
- Negative pole: Insulating stick

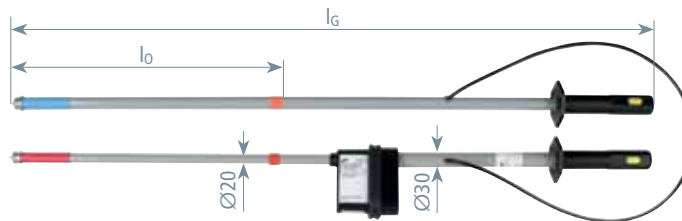

Type	PHEG2.P SN7517
Part No.	767 671
Threshold voltage (U _t)	90 V
Nominal voltage (U _N)	1 ... 24 kV
Length (connecting cable)	1200 mm
Total length (l _G)	1260 mm
Insertion depth (l ₀)	545 mm

PHE/G II for Switchgear Installations and d.c. Links

Two sticks

- For unearthed direct voltage installations
- For d.c. links (e.g. electric locomotives; Part No. 767 647)
- Positive pole: Indicator with test prod
- Negative pole: Insulating stick

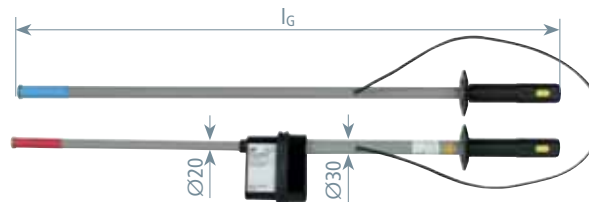

Type	PHEG2 P SN7259	PHEG2 P SN7552	PHEG2 P SN7194
Part No.	767 645	767 647	767 637
Threshold voltage (U _t)	120 V	90 V	750 V
Nominal voltage (U _N)	1 ... 12 kV	1 ... 4.2 kV	1.5 kV
Length (connecting cable)	1200 mm	1200 mm	1200 mm
Total length (l _G)	1085 mm	600 mm	1085 mm

PHE/G II, angled positive Pole

Two sticks

- For unearthed direct voltage installations
- For d.c. links
- Positive pole: Indicator with test prod
- Negative pole: Insulating stick

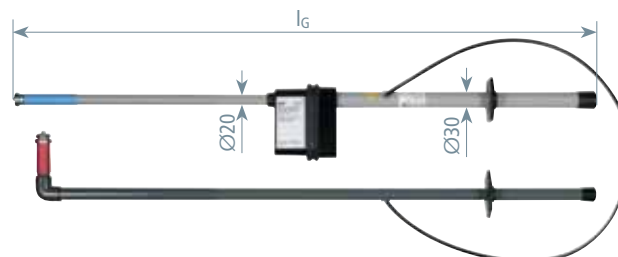

Type	PHEG2 P SN7346
Part No.	767 639
Threshold voltage (U _t)	150 V
Nominal voltage (U _N)	750 V
Length (connecting cable)	1200 mm
Total length (l _G)	1100 mm

3. Verify that the Installation is dead – Voltage Detectors

Two-pole SPN Voltage Detector



Two-pole SPN voltage detector used with extension prods for overhead lines

Nominal Voltages up to 1000 V

- Extremely shock-resistant, waterproof and dust-proof enclosure
- Phase, rotation field and continuity test
- Two versions with different measuring ranges
- For use in overhead line networks by attaching extension prods
- No battery required
- Safe two-hand operation



General Information:

Standard	EN/IEC 61243-3 (DIN VDE 0682-401)
Temperature range	-15 °C ... +45 °C
Degree of protection	IP 65
For use in wet weather conditions	
Material (indicator)	Safety enclosure made of solid rubber
Indication	Moving-iron instrument, LCD and LED
Connecting cable	Rubber-sheathed cable, highly flexible, 1000 mm
Overvoltage category	CAT IV 600 V / CAT III 1000 V in accordance with IEC 60664-1

Nominal Voltage Range up to 1000 V

Basic devices.



Type SPN ...	500PR	1000PR
Part No.	766 544	766 548
Nominal voltage range (U _N)	100 ... 500 V	120 ... 1000 V
Frequency range	0 ... 100 Hz	0 ... 100 Hz
Dimensions (indicator)	274 x 75 x 47 mm	274 x 75 x 47 mm

Accessories for Two-pole SPN Voltage Detector

Extension Prod

For use in overhead line networks, to be screwed onto the basic device.



Type	VS 500 SPN II
Part No.	766 542
Length	500 mm

Artificial Leather Bag, empty

For SPN voltage detectors (basic device with extension prods).



Type	AT SPN II
Part No.	766 543
Dimensions	535 x 160 mm
Colour	Black ●

3. Verify that the Installation is dead – Phase Comparator

Design of Phase Comparators

Phase comparators in accordance with EN/IEC 61481 (DIN VDE 0682-431) are designed for testing for in-phase conditions of three-phase systems.

Only electrically skilled or instructed persons are allowed to test for in-phase conditions. Phase comparators have to be tested for correct operation immediately before and after use.

Phase comparators without self-testing element have to be tested for correct operation by making contact with a part of the installation connected to operating voltage.

Testing for in-phase conditions by means of a phase comparator is considered live working.

Phase comparators may only be used for the nominal voltage / nominal voltage range as indicated on the rating plate. The user may be at risk if the phase comparator is used for voltages other than indicated on the rating plate (incorrect indication, electric shock, arcing).

Phase comparators labelled "For indoor and outdoor installations" must not be used in wet weather conditions.

Phase comparators labelled "Also suitable for use in wet weather conditions" may be used in all weather conditions such as rain, snow, fog and dew.

Phase comparators in accordance with IEC/EN 61481 (VDE 0682-431) are only suitable to a limited extent for use in factory assembled (type tested) installations.

Due to the restricted space in these installations, flashover may occur when inserting the test prod into the installation. The user of the phase comparator or the operator of the switchgear installation must contact the manufacturer of the type-tested installation to find out whether the phase comparator may be used in the installation.

Design of phase comparators

Phase comparators in accordance with IEC/EN 61481 (VDE 0682-431) can be designed as **two-pole devices** (resistive phase comparators) or as **single-pole devices** (capacitive phase comparators).

The design of single-pole phase comparators is similar to that of capacitive voltage detectors. The functional principle of single-pole phase comparators is based on a microprocessor controlled electronic storage system.

PHV and PHV I phase comparators are complete devices and are tested as a complete unit.

Single-pole phase comparators consist of a handle with hand guard, insulating element, indicator and test prod with contact electrode. Two-pole phase comparators additionally have a connecting cable.

The **insulating element** is the section of a phase comparator between the hand guard and the red ring. It ensures that the user maintains an adequate safety distance for safe operation.

The **test prod** with a contact electrode above the red ring allows to reach remote parts of the installation and to eliminate the influence of interference fields.

The **hand guard** provides a visible barrier between the handle and the insulating element and prevents the user from making contact with the insulating element.

The **red ring** indicates the end of the insulating element in the direction of the test electrode. This provides the user with a visible limit of contact with live parts in the installation. The insulating element situated between the red ring and the hand guard must not contact live parts, however, it may contact earthed parts.

The **test electrode** is the part of the phase comparator that is used to make contact with the part of the installation to be tested.

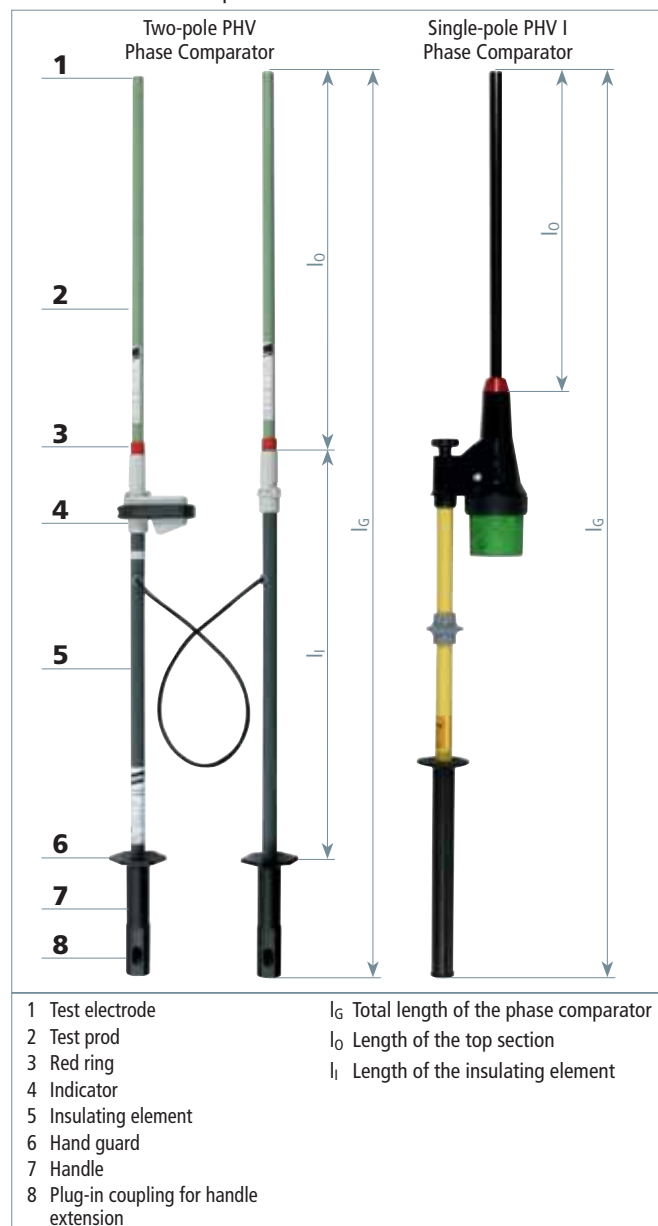

Storage Bags and Transport Cases



Cases: Sheet steel or plastic
Bags: Artificial leather or canvas

161

Maintenance Tests according to German regulations DGUV Vorschrift 3 (former BGV A3)

144



According to the German regulations DGUV Vorschrift 3 (former BGV A3), phase comparators have to be tested for compliance with the prescribed limits as stated in the Electrical Safety Rules. This test is performed in the high-voltage test laboratory of DEHN + SÖHNE and includes

- measurement of the leakage current
- test for clear indication
- test for protection against bridging
- visual inspection, manual tests and measurements

The maintenance test is documented in a test report and on the device.

The test intervals depend on the operating conditions of the phase comparators, e.g. frequency of use, environmental conditions and transport. According to the German regulations DGUV Vorschrift 3, however, it is advisable to carry out a maintenance test **at least every 6 years**.

3. Verify that the Installation is dead – Phase Comparator

Two-pole PHV Phase Comparator



Two-pole PHV phase comparator with a pair of green test prods (15 ... 24 kV) used in a 20 kV switchgear installation

Nominal Voltages up to 24 kV / 50 Hz

Easy and safe testing

- Easy to use
- User-friendly
- Cost-effective / space-saving transport



General Information:

Standard	EN/IEC 61481 (DIN VDE 0682-431)
Temperature range	-25 °C ... +55 °C, climatic category N
Not suitable for use in wet weather conditions	☀
For	Indoor and outdoor installations
Material (test electrode)	Copper alloy/gal Sn
Material (test prod)	Glass-fibre reinforced epoxy resin tube
Material (indicator)	Plastic, fully insulated
Material (insulating stick)	Glass-fibre reinforced epoxy resin tube
Connecting cable	Flexible copper cable, plastic-insulated

The two-pole phase comparator PHV consist of a test unit (basic device) and two test prods (to be ordered separately) which are attached to the test unit.

To avoid confusion, the test prods have different colours according to the nominal voltage.

PHV Test Unit

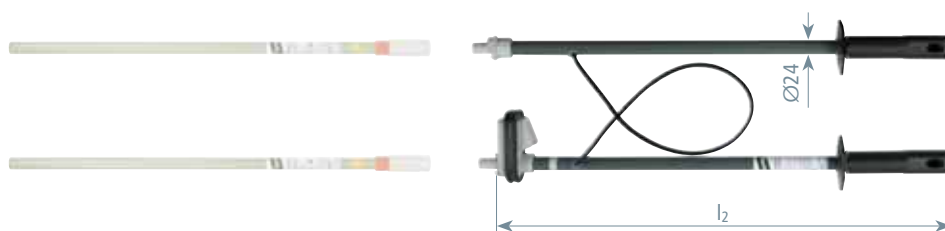

Type	PHV 3 36 STK
Part No.	759 300
Nominal voltage (U _N)	3 ... 36 kV
Colour	Grey ●
Length (test unit) (l ₂)	750 mm
Length (connecting cable)	800 mm

Test Prods, straight

Note: 2 tests prods are required for a test unit.

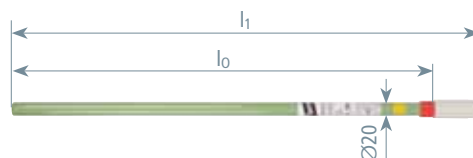

Type	PS 3 3.6 PHV	PS 5 7.2 PHV	PS 10 12 PHV
Part No.	759 603	759 605	759 610
Nominal voltage (U _N)	3 ... 3.6 kV	5 ... 7.2 kV	10 ... 12 kV
Colour	Grey ●	White ○	Yellow ●
Length (test prod) (l ₁)	370 mm	670 mm	670 mm
Insertion depth (l ₀)	305 mm	605 mm	605 mm

Type	PS 10 17.5 PHV	PS 15 24 PHV
Part No.	759 615	759 620
Nominal voltage (U _N)	10 ... 17.5 kV	15 ... 24 kV
Colour	Grey ●	Green ●
Length (test prod) (l ₁)	670 mm	670 mm
Insertion depth (l ₀)	605 mm	605 mm

3. Verify that the Installation is dead – Phase Comparator

Test Prods (Ø11 mm)

For type-tested, factory assembled switchgear installations with limited access (e.g. Mipak).

Note: Two tests prods are required for a test unit.

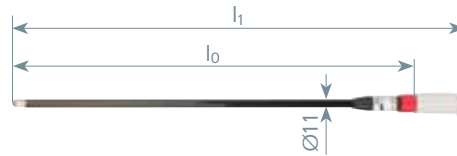

Type	PS 10 12 PHV D11	PS 20 24 PHV D11
Part No.	759 111	759 121
Nominal voltage (U _N)	10 ... 12 kV	20 ... 24 kV
Colour	Black ●	Black ●
Length (test prod) (l ₁)	415 mm	585 mm
Insertion depth (l ₀)	350 mm	520 mm

Test Prods, long

For type-tested, factory assembled switchgear installations with contacts arranged one behind the other in the depth of the installation (e.g. Driescher D600).

Note: Two tests prods are required for a test unit.

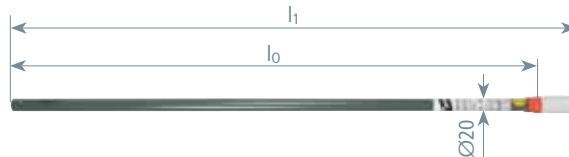

Type	PS 15 24 PHV L880
Part No.	759 621
Nominal voltage (U _N)	15 ... 24 kV
Colour	Grey ●
Length (test prod) (l ₁)	880 mm
Insertion depth (l ₀)	815 mm

Test Prods, 90° angled

For type-tested, factory assembled switchgear installations with limited access and contacts situated in a vertical plane (e.g. Alstom).

Note: Two tests prods are required for a test unit.

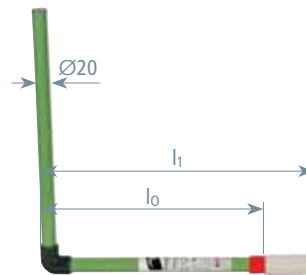

Type	PS 3 3.6 PHV W90	PS 5 7.2 PHV W90	PS 10 12 PHV W90	PS 15 24 PHV W90
Part No.	759 604	759 608	759 611	759 622
Nominal voltage (U _N)	3 ... 3.6 kV	5 ... 7.2 kV	10 ... 12 kV	15 ... 24 kV
Colour	Grey ●	White ○	Yellow ●	Green ●
Length (test prod) (l ₁)	360 mm	360 mm	360 mm	360 mm
Insertion depth (l ₀)	295 mm	295 mm	295 mm	295 mm

3. Verify that the Installation is dead – Phase Comparator

Single-pole PHV I Phase Comparator



Nominal Voltages up to 36 kV / 50 Hz

Safe testing

- Reliable indication



General Information:

Standard	EN/IEC 61481 (DIN VDE 0682-431)
Temperature range	-25 °C ... +55 °C, climatic category N
For use in wet weather conditions	
For	Indoor and outdoor installations
Self-testing element	Yes
Material (test prod)	Plastic
Material (indicator)	Plastic, fully insulated
Material (insulating stick)	Glass-fibre reinforced polyester tube

Single-pole PHV I phase comparator used in a switchgear installation

Nominal Voltage Ranges up to 36 kV / 50 Hz

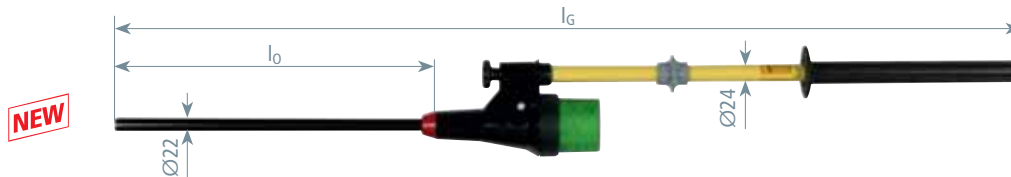

Type PHV1P ...	6 12	10 20	20 36
Part No.	759 706 ^{NEW}	759 712 ^{NEW}	759 736 ^{NEW}
Nominal voltage (UN)	6 ... 12 kV	10 ... 20 kV	20 ... 36 kV
Total length (lG)	1270 mm	1270 mm	1730 mm
Insertion depth (l0)	450 mm	450 mm	910 mm

Nominal Voltage Ranges up to 36 kV / 50 Hz, switchable

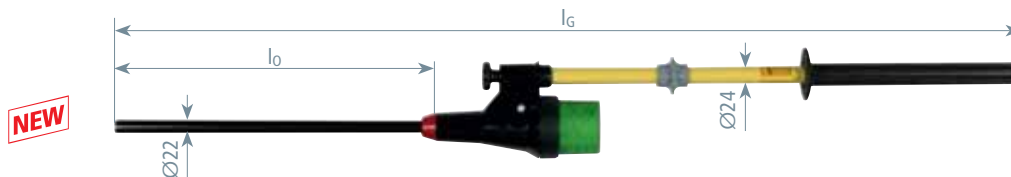

Type PHV1P ...	U 5 36
Part No.	759 716 ^{NEW}
Nominal voltage (UN)	5 ... 10 / 20 ... 36 kV
Total length (lG)	1730 mm
Insertion depth (l0)	910 mm

3. Verify that the Installation is dead – DEHNcap Voltage Detecting System

Product	Type	Nominal voltage U_N / Frequency f_N	Application, Indication	Page
DEHNcap/P Voltage Indicator				
	DEHNcap/P	up to 45 kV / 50 Hz	Passive indicator without batteries LED indication Can also be used as permanent voltage indicator	50
	DEHNcap/P Test Unit	230 V / 50 Hz	For testing for correct operation Plugs into 230 V socket outlets For HR and LRM indicators	
DEHNcap/A Voltage Indicator				
	DEHNcap/A	up to 45 kV / 50 Hz	Active voltage indicator Indication by two separate LEDs With self-testing element and battery monitoring device Automatic deactivation after use	51
DEHNcap/IT Interface Test Unit				
	DEHNcap/IT	up to 45 kV / 50 Hz	Active indicator for maintenance tests Indication by two separate LEDs With self-testing element and battery monitoring system Automatic deactivation after use	52
DEHNcap/PC Phase Comparator				
	DEHNcap/PC-LRM	up to 45 kV / 50 Hz	Active indicator for testing in-phase conditions Indication by three separate LEDs Can be used for HR test sockets with two HR-LRM test adapters Comparator detects zero crossings of the systems to be compared With battery monitoring device	53
DEHNcap HR-LRM Test Set				
	DEHNcap HR-RM Test Set	up to 45 kV / 50 Hz	Fully equipped test set	52
DEHNcap Test Adapter / Measuring Impedance				
	Test Adapter Measuring Impedance			54
Storage Bags and Transport Cases				
			Cases: Sheet steel or plastic Bags: Artificial leather or canvas	161
Maintenance Tests according to German regulations DGUV Vorschrift 3 (former BGV A3)				
			According to the German regulations DGUV Vorschrift 3 (former BGV A3), capacitive voltage detecting systems have to be tested for compliance with the prescribed limits as stated in the Electrical Safety Rules. This test is performed in the high-voltage test laboratory of DEHN + SÖHNE. The maintenance test is documented in a test report and on the device. The test intervals depend on the operating conditions of the capacitive voltage detecting systems, e.g. frequency of use, environmental conditions and transport. According to the German regulations DGUV Vorschrift 3, however, it is advisable to carry out a maintenance test at least every 6 years .	144

3. Verify that the Installation is dead – DEHNcap Voltage Detecting System

DEHNcap/P Voltage Indicator



Nominal Voltages up to 45 kV / 50 Hz
Easy verification of isolation from supply voltage

- Cost-effective

Test for correct operation

EN 50110-1 (DIN VDE 0105-100) requires that voltage indicators be tested for correct operation shortly before and after use.

Passive indicators without self-testing element must be tested for correct operation by plugging them into test sockets connected to operating voltage or into a test unit (DEHNcap/P test unit).

General Information:

Standard	EN/IEC 61243-5 (DIN VDE 0682-415)
Temperature range	-25 °C ... +55 °C
Degree of protection	IP 66
Type of device	Voltage indicator
Use	Can also be used as permanent voltage indicator

DEHNcap/P passive voltage indicator used in an encapsulated switchgear installation

DEHNcap/P-HR



Type SAG DCA P ...	HR GA
Part No.	767 101
Dimensions	40 x 48 x 35 mm
Plug spacing	19 mm
Indication threshold (HR system)	90 V
Input impedance (HR system)	36 Mohms

DEHNcap/P-LRM



Type SAG DCA P ...	LRM GA
Part No.	767 102
Dimensions	40 x 48 x 35 mm
Plug spacing	14 mm
Indication threshold (LRM system)	5 V
Input impedance (LRM system)	2 Mohms

Accessories for DEHNcap/P Voltage Indicator

Test Unit for DEHNcap/P



Type	TG DCA
Part No.	767 110
Nominal voltage (U _N)	230 V
Frequency	50 Hz
Nominal capacity	500 mW
Max. short-circuit current at the test socket	Approx. 20 μA
Dimensions	43 x 75 x 35 mm

3. Verify that the Installation is dead – DEHNcap Voltage Detecting System

Electrical and mechanical interface requirements for pluggable HR, LR and LRM voltage detecting systems

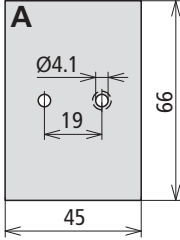
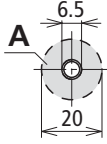
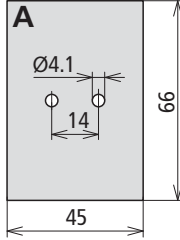
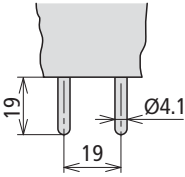
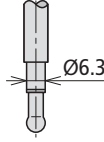
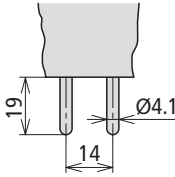
System description		HR high resistance	LR low resistance	LRM low resistance, modified
Input impedance of the indicator	X _c	36 MΩ	2 MΩ	2 MΩ
Electrical response conditions of the interface	I	2.5 μA	2.5 μA	2.5 μA
Electrical response conditions of the interface	U	90 V	5 V	5 V
Socket arrangement and minimum spare area A for indicator or plug				
Plug arrangement				

DEHNcap/A Voltage Indicator

Nominal Voltages up to 45 kV / 50 Hz
Safe verification of isolation from supply voltage

- User-friendly
- Easy application

General Information:	
Standard	EN/IEC 61243-5 (DIN VDE 0682-415)
Temperature range	- 25 °C ... + 55 °C
Field of application	Active voltage indicator for testing
Self-testing element	Yes



Self-test of a DEHNcap/A voltage indicator

DEHNcap/A-LRM

Type	SAG DCA A LRM
Part No.	767 112
Dimensions	120 x 60 x 25 mm
Plug spacing	14 mm
Type of plug	2 multilam plugs (Ø4 mm)
Indication threshold (LRM system)	5 V
Input impedance (LRM system)	2 Mohms



3. Verify that the Installation is dead – DEHNcap Voltage Detecting System

DEHNcap/IT Interface Test Unit



Nominal Voltages up to 45 kV / 50 Hz

Easy and safe testing

- User-friendly
- Easy handling

DEHNcap/IT interface test unit allows to carry out maintenance tests on coupling systems of switchgear installations according to IEC/EN 61243-5 (DIN VDE 0682-415).

General Information:

Standard	EN/IEC 61243-5 (DIN VDE 0682-415)
Temperature range	-25 °C ... +55 °C
Field of application	Active indicator for maintenance tests on coupling systems
Self-testing element	Yes

DEHNcap/IT-LRM



Type	SPG DCA IT LRM
Part No.	767 122
Dimensions	120 x 60 x 25 mm
Plug spacing	14 mm
Type of plug	2 multilam plugs (Ø4 mm)
Input impedance (LRM system)	2 Mohms
Test threshold	3.2 µA

DEHNcap HR-LRM Test Kit



Nominal Voltages up to 45 kV / 50 Hz

Easy and safe testing

- Complete test kit for universal use
- Easy operation

Kit in a plastic case for verifying that the installation is dead and testing the interphase as well as for in-phase conditions in HR and LRM systems.

General Information:

Standard	EN/IEC 61243-5 (DIN VDE 0682-415)
Temperature range	-25 °C ... +55 °C



DEHNcap HR-LRM Test Kit

Type	PS DCA HR LRM
Part No.	767 150
Dimensions	395 x 295 x 105 mm

Kit includes:

Pos.	Part No.	Pos.	Part No.
1	1x 767 112	4	2x 767 133
2	1x 767 122	5	1x 767 107
3	1x 767 132		

For more detailed information on these products, see Accessories chapter.

3. Verify that the Installation is dead – DEHNcap Voltage Detecting System

DEHNcap/PC-LRM Phase Comparator

Nominal Voltages up to 45 kV / 50 Hz

Easy and safe testing

- User-friendly
- Easy handling

General Information:	
Standard	EN/IEC 61243-5 (DIN VDE 0682-415)
Temperature range	-25 °C ... +55 °C
Design	Active indicator for testing for in-phase conditions on LRM test sockets
Field of application	For HR test sockets with two HR-LRM test adapters
Self-testing element	Yes



DEHNcap/PC-LRM phase comparator with two HR-LRM test adapters used in an HR switchgear installation

DEHNcap/PC-LRM

Type PV DCA PC ...	LRM
Part No.	767 132
Dimensions	145 x 85 x 32 mm
Measuring cables	3 measuring cables with multilam plug (Ø4 mm)
Length (measuring cable)	2000 mm
Indication threshold (LRM system)	5 V
Input impedance (LRM system)	2 Mohms



DEHNcap/PC-LRM Phase Comparator Kit

Phase comparator in an artificial leather bag (KLT 23 164).

Type PV DCA PC ...	LRM T
Part No.	767 139
Dimensions	145 x 85 x 32 mm
Measuring cables	3 measuring cables with multilam plug (Ø4 mm)
Length (measuring cable)	2000 mm
Indication threshold (LRM system)	5 V
Input impedance (LRM system)	2 Mohms



Accessories for DEHNcap/PC-LRM Phase Comparator

Artificial Leather Bag, empty

With shoulder strap.

Type	KLT 23 16 4
Part No.	767 500
Suitable for	DCA PC
Dimensions	235 x 160 x 40 mm
Colour	Black ●



3. Verify that the Installation is dead – DEHNcap Voltage Detecting System

DEHNcap Test Adapter / Measuring Impedance



Easy and safe testing

- Easy mechanical and electrical adaptation to HR, LR or XC test sockets
- Measuring impedance for maintenance tests on coupling systems with suitable μA meter
- 4 mm safety plugs or sockets
- Energised HR plug, insulated

General Information:

Standard	EN/IEC 61243-5 (DIN VDE 0682-415)
Temperature range	-25 °C ... +55 °C

The HR-LRM test adapter allows to plug an LRM indicator into a HR test socket

HR-LRM Test Adapter

For electrical and mechanical adaptation of HR (HO) to LRM systems.

Used as a measuring impedance with $X_c = 36$ Mohms for maintenance tests on HR coupling systems (with suitable μA meter).



Type MA DCA ...	HR LRM
Part No.	767 133
Dimensions	90 x 50 x 30 mm
Plug spacing	19 mm
Socket spacing	14 mm
Type of plug	2 multilam plugs ($\varnothing 4$ mm)
Type of test socket	2 sockets ($\varnothing 4$ mm)

LR-LRM Test Adapter

For mechanical adaptation of LR (NO) to LRM systems.



Type MA DCA ...	LR LRM
Part No.	767 136
Dimensions	100 x 50 x 30 mm
Plug spacing	jack, 6.3 mm
Socket spacing	14 mm
Type of plug	1 jack
Type of test socket	2 sockets ($\varnothing 4$ mm)









LRM-XC Measuring Impedance

Used as a measuring impedance with $X_c = 2$ Mohms for maintenance tests on LRM coupling systems (with suitable μA meter).



Type MA DCA ...	XC LRM
Part No.	767 135
Dimensions	90 x 50 x 30 mm
Plug spacing	14 mm
Socket spacing	16 mm
Type of plug	2 multilam plugs ($\varnothing 4$ mm)
Type of test socket	2 sockets ($\varnothing 4$ mm)

4. Carry out Earthing and Short-Circuiting – EaS Devices

Product	Type / Use	Page
Fixed Phase and Earthing Points		
		59
EaS Cables, unequipped		
	One-pole to five-pole	66
Phase Connecting Elements		
	For switchgear installations For overhead lines For railway applications	71 73 76
Earth Connecting Elements		
		77
Earthing Sticks		
	For switchgear installations (single-part and two-part) For overhead lines (telescopic and multi-part) For railway applications	82 84 86
EaS Devices, Short-Circuiting Bars		
		88
Storage Bags and Transport Cases		
	Cases: Sheet steel or plastic Bags: Artificial leather or canvas	161
Maintenance Tests according to German regulations DGUV Vorschrift 3 (former BGV A3)		
	<p>According to the German regulations DGUV Vorschrift 3 (former BGV A3), §5 section 1 it shall be checked whether the equipment, such as earthing and short-circuiting devices, is in good order and condition at certain intervals. The intervals must be chosen so that the defects to be expected are detected in due time. These tests are performed at DEHN + SÖHNE or on site in compliance with a new measuring method*) and includes</p> <ul style="list-style-type: none"> – visual inspection for signs of damage or defect – measurement of total resistance at the stationary earthing and short-circuiting device (static test) – measurement of the relative resistance change in the cable and at the connecting points of the portable earthing and short-circuiting device (dynamic test) <p>The maintenance test is documented in a test report and on the device.</p> <p>*) This measuring method has been developed on behalf of GB ETEM at the University of Technology and Economy in Dresden, Germany.</p>	144

4. Carry out Earthing and Short-Circuiting – EaS Devices

Earthing and Short-Circuiting Devices

Earthing and short-circuiting at the work location is a key element of the five safety rules. This measure ensures that the installation is de-energised when working on electrical equipment even in case of interference voltages, atmospheric surges or accidental reconnection.

Isolation from supply voltage must be verified at the point of installation immediately before portable earthing and short-circuiting equipment is installed.

When installing earthing and short-circuiting devices, the earthing cable always has to be connected to the earthing system first to ensure that residual or interference voltages are discharged.

Portable earthing and short-circuiting equipment according to IEC/EN 61230 (DIN VDE 0683-100) is a hand-held device used to approach fixed connection points of an electrical installation for earthing and short-circuiting purposes (according to EN 50110-1 (DIN VDE 0105-100), section 6.2.4) and for connection with the fixed connection points without guide slots, bushings or guide rails. It consists of an earthing and short-circuiting device (EaS device) and an earthing stick.

The purpose of **earthing and short-circuiting devices** is to earth and short-circuit electrical conductors. They consist of an earthing and short-circuiting device. The **earthing device** connects the earthing system with a short-circuiting device or with the equipment to be earthed. It consists of an earth clamp (1) and an earthing cable (4).

The **short-circuiting device** connects the phase conductors that have to be short-circuited. It consists of clamps (1+2), short-circuiting cables or bars (3) and connecting clusters (5), if required.

The **short-circuiting bar** is a rigid short-circuiting device.

Connecting clusters connect the short-circuiting cables with each other and with the earthing cable or the short-circuiting bar with the earthing cable.

Connecting clamps connect the earthing and short-circuiting cables or bars to the earthing system either directly or via connecting links such as cable lugs and to parts of the installation via fixed connection points, if required. **Fixed connection points** are parts of the installation to which earthing and short-circuiting devices are connected (e.g. conductors, bars, fixed ball points, cylinder bolts, clamps etc.). Maximum short-circuit strength can be achieved by connecting the fixed ball point with the ball head cap of the earthing and short-circuiting device.

An **earthing stick** is a hand-held insulating stick for approaching clamps of earthing and short-circuiting devices to parts of electrical installations for earthing and short-circuiting purposes. It consists of an insulating element, black ring, handle and coupling for attaching clamps. Earthing sticks are selected according to the **weight** of the earthing and short-circuiting devices to be connected (see "max. load on operating head in kg").

The **insulating element** is the part of the earthing stick between the black ring and the end of the earthing stick in the direction of the clamp. It ensures that the user maintains the required safe distance and provides sufficient insulation. The insulating element l_i must have a minimum length of 500 mm in installations exceeding 1 kV.

A complete earthing and short-circuiting device according to IEC/EN 61230 (DIN VDE 0683-100) includes, for example:

- Fixed point / Fixed ball point
- Single-pole or three-pole earthing and short-circuiting device or short-circuiting bar
- Fixed earthing point
- Earthing stick

Earthing and short-circuiting devices as well as the fixed ball and earthing points must be rated to withstand the **short-circuit current conditions** expected on site. The required cable cross-section depends on the maximum short-circuit current (I_k in A) and the maximum short-circuit time (T_k in s).

Note:

In the event of a short-circuit, the short-circuit current will flow through the short-circuiting device. However, this is different for earthing devices as they do not conduct short-circuit currents and can therefore be rated for lower values.

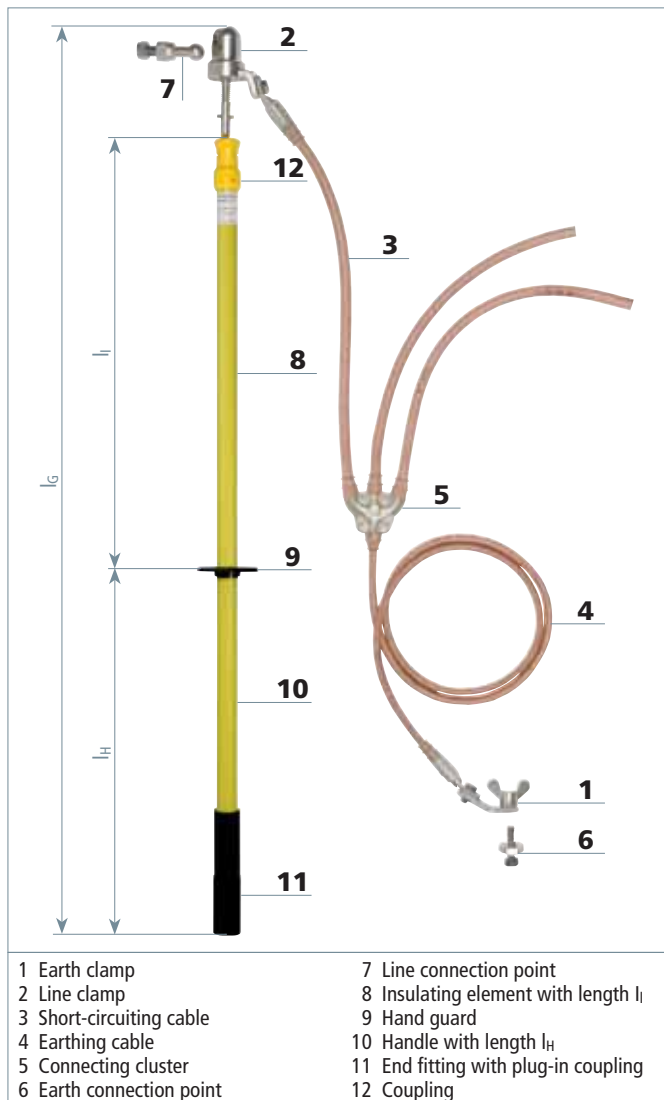

Portable earthing and short-circuiting equipment

Cable cross-section:

For short-circuiting cables of our three-pole earthing and short-circuiting devices with cross-sections of 50 mm² and higher, the **cross-section of the earthing cable** can be reduced according to the following table.

These earthing and short-circuiting devices with reduced earthing cable cross-sections can be used for all non-solidly earthed neutral systems (e.g. **compensated systems** with impedance neutral earthing). For **solidly earthed neutral systems**, the earthing and short-circuiting cables must have the same cross-sections.

The current carrying capacity of the short-circuiting cable and the short-circuiting bar depends on the material, the cross-section (A) and the short-circuit time (T_k).

Calculations were based on the most critical case, i.e. an off-generator short circuit ($\mu = 1$) and a maximum d.c. components ($\chi = 1.8$) with I_k'' being the maximum initial short-circuit alternating current, which, according to DIN VDE 0102, is equal to the permanent short-circuit current I_k and the breaking current I_a :

$$I_k'' = I_k = I_a$$

The diagrams or the table help to determine the required cable or busbar cross-sections of short-circuiting devices according to the short-circuit current and the short-circuit time of an installation.

Cable Cross-Section	
Short-circuiting cable	Earthing cable
16 mm ²	16 mm ²
25 mm ²	25 mm ²
35 mm ²	35 mm ²
50 mm ²	25 mm ²
70 mm ²	35 mm ²
95 mm ²	35 mm ²
120 mm ²	50 mm ²
150 mm ²	50 mm ²

4. Carry out Earthing and Short-Circuiting – EaS Devices

Current carrying capacity of copper short-circuiting cables for use in a.c. and three-phase installations

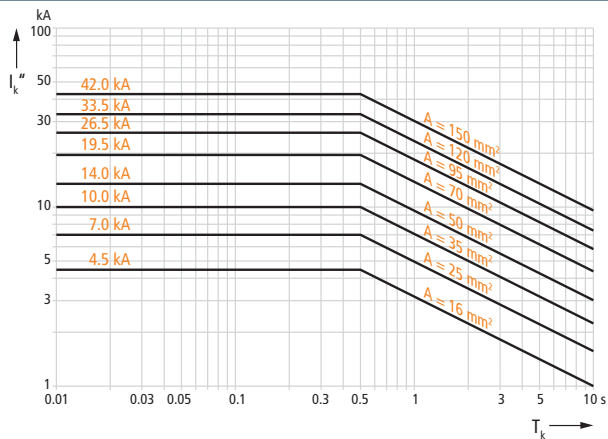

Initial cable temperature 20 °C

Final cable temperature 250 °C

$$A = 5.07 I_k'' \sqrt{T_k} \quad \text{for } T_k \geq 0.5 \text{ s}$$

Where:

A Cable cross-section in mm²I_k'' Maximum initial short-circuit alternating current in kA according to DIN VDE 0102T_k Short-circuit time in s

Current carrying capacity of E-Cu F20 short-circuiting bars

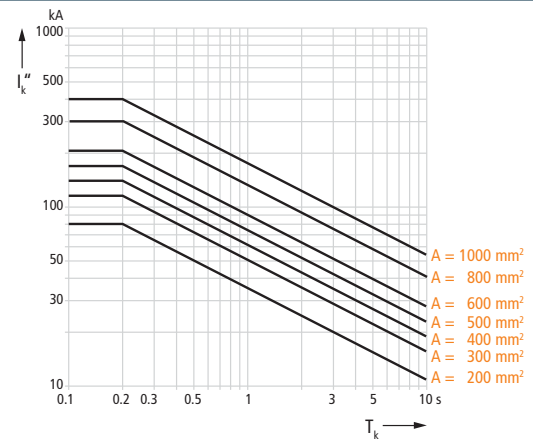

Initial cable temperature 20 °C

Final cable temperature 250 °C

$$A = 5.54 I_k'' \sqrt{T_k} \quad \text{for } T_k \geq 0.2 \text{ s}$$

Where:

A Busbar cross-section in mm²I_k'' Maximum initial short-circuit alternating current in kA according to DIN VDE 0102T_k Short-circuit time in s

Current carrying capacity of copper short-circuiting cables for use in d.c. installations

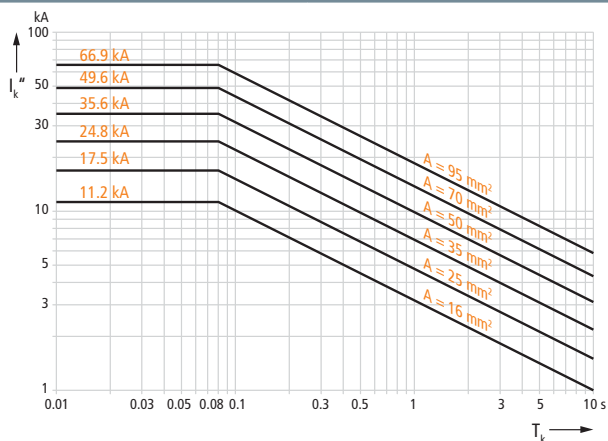

Initial cable temperature 20 °C

Final cable temperature 250 °C

$$A = 5.07 I_k'' \sqrt{T_k} \quad \text{for } T_k \geq 0.08 \text{ s}$$

Where:

A Cable cross-section in mm²I_k'' Maximum initial short-circuit alternating current in kA according to DIN VDE 0102T_k Short-circuit time in s

Current carrying capacity of E-AlMgSi 0.5 F17 short-circuiting bars

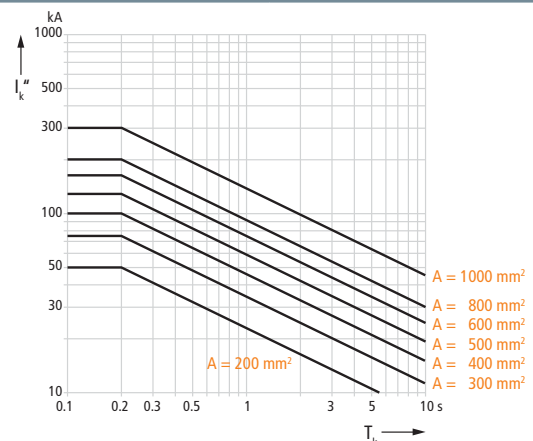

Initial cable temperature 20 °C

Final cable temperature 250 °C

$$A = 8.79 I_k'' \sqrt{T_k} \quad \text{for } T_k \geq 0.2 \text{ s}$$

Where:

A Busbar cross-section in mm²I_k'' Maximum initial short-circuit alternating current in kA according to DIN VDE 0102T_k Short-circuit time in s

Current carrying capacity of copper short-circuiting cables for use on overhead contact lines of electric railways

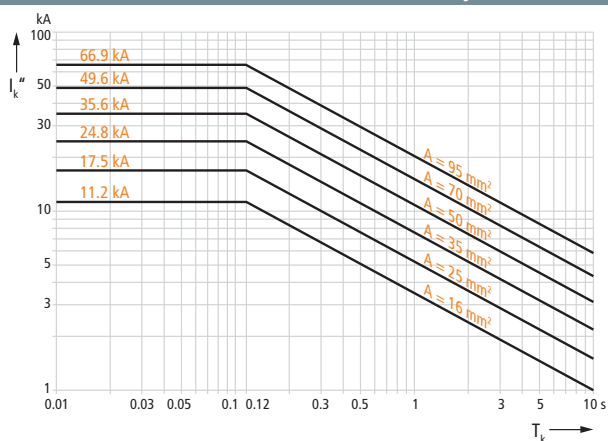

Initial cable temperature 20 °C

Final cable temperature 400 °C

$$A = 4.1 I_k'' \sqrt{T_k} \quad \text{for } T_k \geq 0.12 \text{ s}$$

Where:

A Cable cross-section in mm²I_k'' Maximum initial short-circuit alternating current in kA according to DIN VDE 0102T_k Short-circuit time in s

4. Carry out Earthing and Short-Circuiting – EaS Devices

Calculation example:

Known: Mains breaking capacity S_a
Short-circuit time T_k

Unknown: Required cable or bar cross-section A.

The calculation is based on an off-generator short-circuit.

$$\text{Three-phase current } I_k'' = I_k = I_a = \frac{S_a}{\sqrt{3} \cdot U_N}$$

$$\text{Single-phase alternating current } I_k'' = I_k = I_a = \frac{S_a}{U_N}$$

The required cable or bar cross-section can now be calculated based on I_k'' of the above equations or can be taken from the diagrams. The permissible current carrying capacity of an earthing and short-circuiting device is based on the cross-section printed on the short-circuiting cables or bars.

Note:

- Earthing and short-circuiting devices can only be loaded once with the permissible short-circuit currents depending on the short-circuit time.
- Short-circuiting cables of multi-pole earthing and short-circuiting devices must have the same cross-sections.
- Cable lengths of earthing and short-circuiting devices should be at least 120% of the distance between two fixed connection points. They should be as short as possible as the cables move violently during a short-circuit.
- When connecting earthing and short-circuiting devices in parallel with cables for achieving certain total cable cross-sections, the following conditions must be fulfilled:
 1. Identical cable lengths and cross-sections,
 2. Identical connecting clamps and fixed connection points
 3. Installing the devices directly next to each other, with parallel arrangement of cables,
 4. The current carrying capacity per cable must be reduced to 75% of the current carrying capacity of the cable cross-section.

Remark:

If it is ensured that earthing and short-circuiting devices connected in parallel are loaded with short-circuit currents only once (no interruption of the short circuit), the devices may be exposed to the full load. Generally, this applies to installations with nominal voltages above 110 kV.

Table:

Cable cross-section of the earthing and short-circuiting device depending on the maximum short-circuit I_k and maximum short-circuit time T_k .

Cross-section of the copper cable	Max. short-circuit current I_k at a duration of				
	10 s	5 s	2 s	1 s *)	≤ 0.5 s *)
16 mm ²	1 000 A	1 400 A	2 200 A	3 200 A	4 500 A
25 mm ²	1 600 A	2 200 A	3 500 A	4 900 A	7 000 A
35 mm ²	2 200 A	3 100 A	4 900 A	6 900 A	10 000 A
50 mm ²	3 100 A	4 400 A	7 000 A	9 900 A	14 000 A
70 mm ²	4 400 A	6 200 A	9 800 A	13 800 A	19 500 A
95 mm ²	5 900 A	8 400 A	13 200 A	18 700 A	26 500 A
120 mm ²	7 500 A	10 600 A	16 700 A	23 700 A	33 500 A
150 mm ²	9 400 A	13 200 A	20 900 A	29 600 A	42 000 A

*) catalogue data

4. Carry out Earthing and Short-Circuiting – EaS Devices

Fixed Ball Points

Ø20 or 25 mm

- Suitable for fixing cable lugs or connecting busbars in accordance with DIN 43673-1
- Self-locking nut
- M12 or M16 female thread (not cut)
- M12 or M16 threaded pin

General Information:	
Standard	EN/IEC 61230 (DIN VDE 0683-100) and based on DIN 48088-1
Material (fixed ball point)	E-Cu/gal Sn
Material (threaded pin)	StSt A2-70
Hexagon nut	DIN 985-M12-8 / gal Zn; DIN 985-M16-8 / gal Zn
Tightening torque	M12: 80 Nm; M16: 150 Nm



Straight fixed ball point mounted on a busbar

Angled with Terminal Lug

Type KFP ...	20 S AL 12	25 S AL 12
Part No.	706 300	756 300
Fixed ball point Ø	20 mm	25 mm
Dimensions	45 x 30 x 9 mm	50 x 30 x 9 mm
Max. cable cross-section Cu	50 mm ²	95 mm ²
Max. short-circuit current I _k 0.5 s	14 kA	26.5 kA
Max. short-circuit current I _k 1 s	9.9 kA	18.7 kA



Straight with Threaded Pin and Self-locking Nut

Type KFP ...	20 M12 35 SSM	20 M16 45 SSM	25 M12 25 SSM	25 M12 45 SSM	25 M16 45 SSM
Part No.	754 235	754 645	755 225	755 245	755 645
Fixed ball point Ø	20 mm	20 mm	25 mm	25 mm	25 mm
Dimensions	M12 x 35 mm	M16 x 45 mm	M12 x 25 mm	M12 x 45 mm	M16 x 45 mm
Width A/F	24 mm	24 mm	27 mm	27 mm	27 mm
Max. cable cross-section Cu	120 mm ²	120 mm ²	150 mm ²	150 mm ²	150 mm ²
Max. short-circuit current I _k 0.5 s	33.5 kA	33.5 kA	42.0 kA	42.0 kA	42.0 kA
Max. short-circuit current I _k 1 s	23.7 kA	23.7 kA	29.6 kA	29.6 kA	29.6 kA



Straight with Female Thread

Type KFP ...	20 M10	20 M12	20 M16	25 M12	25 M16
Part No.	754 205	754 200	754 600	755 200	755 600
Fixed ball point Ø	20 mm	20 mm	20 mm	25 mm	25 mm
Dimensions	M10 mm	M12 mm	M16 mm	M12 mm	M16 mm
Width A/F	24 mm	24 mm	24 mm	27 mm	27 mm
Max. cable cross-section Cu	120 mm ²	120 mm ²	120 mm ²	150 mm ²	150 mm ²
Max. short-circuit current I _k 0.5 s	33.5 kA	33.5 kA	33.5 kA	42.0 kA	42.0 kA
Max. short-circuit current I _k 1 s	23.7 kA	23.7 kA	23.7 kA	29.6 kA	29.6 kA



4. Carry out Earthing and Short-Circuiting – EaS Devices

Straight with Threaded Pin, Nut and Washer



Type KFP ...	25 M16 25 SKM	25 M12 35 SKM	25 M16 45 SKM
Part No.	755 626	755 627	755 646
Fixed ball point Ø	25 mm	25 mm	25 mm
Dimensions	M16 x 25 mm	M12 x 35 mm	M16 x 45 mm
Max. short-circuit current I_k 0.06 s	34.0 kA	34.0 kA	34.0 kA
DB drawing No.	3 Ebgw 01.63	3 Ebgw 01.63	3 Ebgw 01.63
DB material No.	157 541	622 014	157 542

Straight with Threaded Pin



Type KFP ...	25 M16 25
Part No.	755 636
Fixed ball point Ø	25 mm
Dimensions	M16 x 25 mm
Max. short-circuit current I_k 0.06 s	34.0 kA
DB drawing No.	3 Ebgw 01.63
DB material No.	609 426

Straight with Round Conductor Half Shell for Round Copper Conductors

Type KFP ...	20 RL 10	20 RL 12	20 RL 14	20 RL 16
Part No.	720 010	720 012	720 014	720 016
Fixed ball point Ø	20 mm	20 mm	20 mm	20 mm
For round conductor Ød	10 mm	12 mm	14 mm	16 mm
Max. cable cross-section Cu	50 mm ²	50 mm ²	50 mm ²	50 mm ²
Max. short-circuit current I_k 0.5 s	14 kA	14 kA	14 kA	14 kA
Max. short-circuit current I_k 1 s	9.9 kA	9.9 kA	9.9 kA	9.9 kA

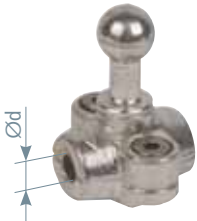

Type KFP ...	20 RL 18	20 RL 20	25 RL 10	25 RL 12
Part No.	720 018	720 020	725 010	725 012
Fixed ball point Ø	20 mm	20 mm	25 mm	25 mm
For round conductor Ød	18 mm	20 mm	10 mm	12 mm
Max. cable cross-section Cu	50 mm ²	50 mm ²	95 mm ²	95 mm ²
Max. short-circuit current I_k 0.5 s	14 kA	14 kA	26.5 kA	26.5 kA
Max. short-circuit current I_k 1 s	9.9 kA	9.9 kA	18.7 kA	18.7 kA

Type KFP ...	25 RL 14	25 RL 16	25 RL 18	25 RL 20
Part No.	725 014	725 016	725 018	725 020
Fixed ball point Ø	25 mm	25 mm	25 mm	25 mm
For round conductor Ød	14 mm	16 mm	18 mm	20 mm
Max. cable cross-section Cu	95 mm ²	95 mm ²	95 mm ²	95 mm ²
Max. short-circuit current I_k 0.5 s	26.5 kA	26.5 kA	26.5 kA	26.5 kA
Max. short-circuit current I_k 1 s	18.7 kA	18.7 kA	18.7 kA	18.7 kA

45° angled with Threaded Pin and Self-locking Nut



Type KFP ...	20 W45 M12 35SSM	20 W45 M16 45SSM	25 W45 M12 45SSM	25 W45 M16 45SSM
Part No.	706 235	706 645	756 245	756 645
Fixed ball point Ø	20 mm	20 mm	25 mm	25 mm
Dimensions	M12 x 35 mm	M16 x 45 mm	M12 x 45 mm	M16 x 45 mm
Width A/F	24 mm	24 mm	27 mm	27 mm
Max. cable cross-section Cu	70 mm ²	70 mm ²	95 mm ²	95 mm ²
Max. short-circuit current I_k 0.5 s	19.5 kA	19.5 kA	26.5 kA	26.5 kA
Max. short-circuit current I_k 1 s	13.8 kA	13.8 kA	18.7 kA	18.7 kA

4. Carry out Earthing and Short-Circuiting – EaS Devices

45° angled with Female Thread

Type KFP ...	20 W45 M12	20 W45 M16	25 W45 M12	25 W45 M16
Part No.	706 200	706 600	756 200	756 600
Fixed ball point Ø	20 mm	20 mm	25 mm	25 mm
Dimensions	M12 mm	M16 mm	M12 mm	M16 mm
Width A/F	24 mm	24 mm	27 mm	27 mm
Max. cable cross-section Cu	70 mm ²	70 mm ²	95 mm ²	95 mm ²
Max. short-circuit current I _k 0.5 s	19.5 kA	19.5 kA	26.5 kA	26.5 kA
Max. short-circuit current I _k 1 s	13.8 kA	13.8 kA	18.7 kA	18.7 kA



90° angled with Threaded Pin and Self-locking Nut

Type KFP ...	20 W90 M12 35SSM	20 W90 M16 45SSM	25 W90 M12 45SSM	25 W90 M16 45SSM
Part No.	707 235	707 645	757 245	757 645
Fixed ball point Ø	20 mm	20 mm	25 mm	25 mm
Dimensions	M12 x 35 mm	M16 x 45 mm	M12 x 45 mm	M16 x 45 mm
Width A/F	24 mm	24 mm	27 mm	27 mm
Max. cable cross-section Cu	70 mm ²	70 mm ²	95 mm ²	95 mm ²
Max. short-circuit current I _k 0.5 s	19.5 kA	19.5 kA	26.5 kA	26.5 kA
Max. short-circuit current I _k 1 s	13.8 kA	13.8 kA	18.7 kA	18.7 kA



90° angled with Female Thread

Type KFP ...	20 W90 M12	20 W90 M16	25 W90 M12	25 W90 M16
Part No.	707 200	707 600	757 200	757 600
Fixed ball point Ø	20 mm	20 mm	25 mm	25 mm
Dimensions	M12 mm	M16 mm	M12 mm	M16 mm
Width A/F	24 mm	24 mm	27 mm	27 mm
Max. cable cross-section Cu	70 mm ²	70 mm ²	95 mm ²	95 mm ²
Max. short-circuit current I _k 0.5 s	19.5 kA	19.5 kA	26.5 kA	26.5 kA
Max. short-circuit current I _k 1 s	13.8 kA	13.8 kA	18.7 kA	18.7 kA



4. Carry out Earthing and Short-Circuiting – EaS Devices

Fixed Earthing Points



Fixed earthing point with ring groove and earth bushing.



Bolted-type earth connector with M12 threaded pin on an earthed part of an installation.

Ring Groove and Connecting Elements

- For connecting earth bushings or earth connecting plates in accordance with DIN 48088-2
- Welding-type or bolted-type connector for connecting earth connectors with wing nut or wing bolt on the earth cable end
- Connectors with M12 or M16 threaded pin
- M12 or M16 female thread

General Information:

Standard	EN/IEC 61230 (DIN VDE 0683-100) and DIN 48088-2 and -5
Material (fixed point)	Brass (CuNi2Si) / gal Sn
Material (threaded pin)	StSt A2-70
Hexagon nut	DIN 985-M12-8 / gal Zn; DIN 985-M16-8 / gal Zn
Tightening torque	M12: 80 Nm; M16: 150 Nm

Ring Groove Fixed Point with Threaded Pin and Nut



Type	EFP 16 RN M12 35 SSM	EFP 16 RN M16 45 SSM
Part No.	790 251	790 261
Dimensions	M12 x 35 mm	M16 x 45 mm
Diameter	16 mm	16 mm
Width A/F	22 mm	22 mm
Max. cable cross-section Cu	150 mm ²	150 mm ²
Max. short-circuit current I _k 0.5 s	42 ^{*)} kA	42 ^{*)} kA
Max. short-circuit current I _k 1 s	29.6 ^{*)} kA	29.6 ^{*)} kA

Ring Groove Fixed Point with Female Thread



Type	EFP 16 RN M12	EFP 16 RN M16
Part No.	790 250	790 260
Dimensions	M12 mm	M16 mm
Diameter	16 mm	16 mm
Width A/F	22 mm	22 mm
Max. cable cross-section Cu	150 mm ²	150 mm ²
Max. short-circuit current I _k 0.5 s	42 ^{*)} kA	42 ^{*)} kA
Max. short-circuit current I _k 1 s	29.6 ^{*)} kA	29.6 ^{*)} kA

^{*)} For earthing and short-circuiting devices with cable lengths > 4000 mm: 26.5 kA / 0.5 s (18.7 kA / 1 s)

Welding-type Connector with Threaded Pin



Type	AS SCHW M12 25	AS SCHW M16 30
Part No.	705 501	755 501
Dimensions	M12 x 25 mm	M16 x 30 mm
Max. cable cross-section Cu	150 mm ²	150 mm ²
Max. short-circuit current I _k 0.5 s	42 kA	42 kA
Max. short-circuit current I _k 1 s	29.6 kA	29.6 kA

Welding-type Connector with Female Thread



Type	AS SCHW M12	AS SCHW M16
Part No.	336 020	336 025
Dimensions	M12 mm	M16 mm
Max. cable cross-section Cu	150 mm ²	150 mm ²
Max. short-circuit current I _k 0.5 s	42 kA	42 kA
Max. short-circuit current I _k 1 s	29.6 kA	29.6 kA

4. Carry out Earthing and Short-Circuiting – EaS Devices

Bolted-type Connector with Female Thread

Type	AS SCHR M12 M12 40	
Part No.	705 504	
Dimensions	M12 / M12 x 40 mm	
Width A/F	27 mm	
Max. cable cross-section Cu	150 mm ²	
Max. short-circuit current I_k 0.5 s	42 kA	
Max. short-circuit current I_k 1 s	29.6 kA	



Bolted-type Connector with Threaded Pin and Separate Hexagon Nut

Type	AS SCHR M12 55	AS SCHR M16 65
Part No.	705 500	750 500
Dimensions	M12 x 55 mm	M16 x 65 mm
Width A/F	32 mm	41 mm
Max. cable cross-section Cu	150 mm ²	150 mm ²
Max. short-circuit current I_k 0.5 s	42 kA	42 kA
Max. short-circuit current I_k 1 s	29.6 kA	29.6 kA



Bolted-type Connector for Converting from M12 to M16 Threaded Pin

Type	AS SCHR M16 55 M12	
Part No.	705 510	
Dimensions	M12 x 20 / M16 x 55 mm	
Width A/F	41 mm	
Max. cable cross-section Cu	150 mm ²	
Max. short-circuit current I_k 0.5 s	42 kA	
Max. short-circuit current I_k 1 s	29.6 kA	



Earth Connecting Plates

- Connecting plate with high short-circuit current carrying capacity
- Single-pole connection of the phase arms
- For connecting single-pole earthing and short-circuiting devices to transformers of overhead line masts or to fuse holders
- For fixed ball points (Ø20 mm, Ø25 mm) or ring groove pins (Ø16 mm)

General Information:	
Standard	EN/IEC 61230 (DIN VDE 0683-100) and fixed points in accordance with DIN 48088-1
Material (plate)	Aluminium
Material (terminal lug)	4 mm: Cu / gal Sn; 6 mm: St / tZn
Material (fixed point)	E-Cu / brass (CuNi2Si) / gal Sn



Earth connecting plate with fixed ball points and ball head cap with plastic handle

With three Fixed Ball Points and Ball Head Cap

Type	EAPA 3 KFP 20 KKH	EAPA 3 KFP 25 KKH
Part No.	728 620	728 625
Fixed point Ø	20 mm	25 mm
Max. cable cross-section Cu	120 mm ²	150 mm ²
Max. short-circuit current I_k 0.5 s	33.5 kA	42.0 kA
Max. short-circuit current I_k 1 s	23.7 kA	29.6 kA



4. Carry out Earthing and Short-Circuiting – EaS Devices

With three Fixed Ball Points

To be mounted on earth connecting clamps with anti-rotation element (PK1).



Type	EAPA 3 KFP 20 B13	EAPA 3 KFP 25 B13
Part No.	728 522	728 526
Fixed point Ø	20 mm	25 mm
Max. cable cross-section Cu	120 mm ²	150 mm ²
Max. short-circuit current I _k 0.5 s	33.5 kA	42.0 kA
Max. short-circuit current I _k 1 s	23.7 kA	29.6 kA

With three Ring Groove Fixed Points and Earth Bushing

Type	EAPA 3 RN 16 EAB
Part No.	728 516
Fixed point Ø	16 mm
Max. cable cross-section Cu	95 mm ²
Max. short-circuit current I _k 0.5 s	26.5 kA
Max. short-circuit current I _k 1 s	18.7 kA

With three Ring Groove Fixed Points

To be mounted on earth connecting clamps with anti-rotation element (PK1).



Type	EAPA 3 RN 16 B13
Part No.	728 506
Fixed point Ø	16 mm
Max. cable cross-section Cu	95 mm ²
Max. short-circuit current I _k 0.5 s	26.5 kA
Max. short-circuit current I _k 1 s	18.7 kA

**With two Fixed Ball Points and Ball Head Cap**

With adjustable ball head cap (Ø25 mm) and plastic handle.

For connecting two single-pole earthing and short-circuiting devices to one fixed ball point Ø25 mm.



Type	EAP 2 25 KKH HG
Part No.	728 501
Fixed point Ø	25 mm
DB drawing No.	3 Ebgw 01.66
DB material No.	157 540

**Terminal Lug with one Fixed Ball Point**

To be connected to a fuse holder.



Type	EAP 25 SIT US OL
Part No.	728 503
Fixed point Ø	25 mm
DB drawing No.	4 Ebgw 01.60
DB material No.	157 545

**Terminal Lug with two Fixed Ball Points**

To be connected to a tower.



Type	EAP 2 25 MA US OL
Part No.	728 502
Fixed point Ø	25 mm
DB drawing No.	3 Ebgw 01.61
DB material No.	157 548

4. Carry out Earthing and Short-Circuiting – EaS Devices

Fixed Phase Points

- Coupling aid (clamp) for phase screw clamps 25 mm
- For high-voltage installations up to 220 kV
- Other types of clamps, e.g. for twin conductors or greater clamp widths available on request



Fixed phase point mounted on an overhead line conductor

General Information:

Standard	Clamp in accordance with DIN 48088-3
Clamp material	Aluminium or copper alloy
Bolt material	StSt

Fixed Phase Points for Al and Al/St Overhead Line Conductors

Type PFP	AL 60 82	AL 60 98	AL 60 126
Part No.	731 011	731 013	731 015
Clamp width b	82 mm	98 mm	126 mm
For conductors $\varnothing d$	11.0 ... 33 mm	33.1 ... 48 mm	48.1 ... 70 mm
Max. short-circuit current I_k 0.5 s	33.5 kA	33.5 kA	33.5 kA
Max. short-circuit current I_k 1 s	23.7 kA	23.7 kA	23.7 kA



Fixed Phase Points for Cu Round Conductors

Type PFP	CU 60 82	CU 60 98
Part No.	731 027	731 037
Clamp width b	82 mm	98 mm
For conductors $\varnothing d$	11.0 ... 33 mm	33.1 ... 48 mm
Max. short-circuit current I_k 0.5 s	33.5 kA	33.5 kA
Max. short-circuit current I_k 1 s	23.7 kA	23.7 kA



Note: The exact conductor / cable diameter d must be specified when ordering!

4. Carry out Earthing and Short-Circuiting – EaS Devices

Earthing and Short-Circuiting Cables, unequipped



Equipped three-pole earthing and short-circuiting device in a switchgear installation

- To be equipped with connecting components
- Transparent sheath
- Waterproof and plastic-sheathed cable entries and node unit, additional anti-kink protection
- Standard anti-rotation crimped cable lugs (type PK1)
- Other cable lengths and crimped cable lugs can be selected online via the earthing and short-circuiting configurator
- Earthing and short-circuiting devices can be configured online via the earthing and short-circuiting configurator

General Information:

Standard	EN/IEC 61138 (DIN VDE 0283-3) and EN/IEC 61230 (DIN VDE 0683-100)
Temperature range	-25 °C ... +55 °C
Material (cable)	E-Cu, extra finely stranded and highly flexible
Material (sheath)	Thermoplastic polymer (flexible PVC compound YM2)
Hole (cable lug)	Ø12.5 mm



Crimped cable lugs, type PK1:
Standard anti-rotation cable lug with cut-out.





Crimped cable lugs, type PK2:
Cable lugs without cut-out for connecting parts from other manufacturers are available on request.



Crimped cable lugs, type PK3:
Hook-type cable lugs up to cable cross-sections of 35 mm² are available on request.

*) Clamping range and maximum cable cross-section of universal clamps used for:

Fixed ball point Ø	T Pin Collar width	Rd / Fl Clamping range	Max. cable cross-section	Max. short-circuit current	
				I _k 0.5 s	I _k 1 s
 20 / 25 / 30 mm	 15 / 18 mm	 20 / 30 mm	16 mm ²	4.5 kA	3.2 kA
20 / 25 / 30 mm	15 / 18 mm	20 / 30 mm	25 mm ²	7.0 kA	4.9 kA
20 / 25 / 30 mm	15 / 18 mm	20 / 30 mm	35 mm ²	10.0 kA	6.9 kA
20 / 25 / 30 mm	15 / 18 mm	20 / 30 mm	50 mm ²	14.0 kA	9.9 kA
20 / 25 / 30 mm	15 / 18 mm	20 / 30 mm	70 mm ²	19.5 kA	13.8 kA
20 / 25 / 30 mm	15 / 18 mm	—	95 mm ²	26.5 kA	18.7 kA
— / 25 / 30 mm	—	—	120 mm ²	33.5 kA	23.7 kA
—	—	—	150 mm ²	42.0 kA	29.6 kA

4. Carry out Earthing and Short-Circuiting – EaS Devices

Single-pole Earthing and Short-Circuiting Cables



General Information:

Crimped cable lug	PK1
-------------------	-----

Type	EKV1+0 16 V4YPRGE	EKV1+0 25 VSY71K4	EKV1+0 35 V9JF26K	EKV1+0 50 VRJG23Y
Variant No.	V4YPRGE	VSY71K4	V9JF26K	VRJG23Y
Cable cross-section	16 mm ²	25 mm ²	35 mm ²	50 mm ²
Material	Cu	Cu	Cu	Cu
Max. short-circuit current I_k 0.5 s	4.5 kA	7.0 kA	10.0 kA	14.0 kA
Max. short-circuit current I_k 1 s	3.2 kA	4.9 kA	6.9 kA	9.9 kA

Type	EKV1+0 70 VPZBBSL	EKV1+0 95 VZC3FST	EKV1+0 120 V797FE6	EKV1+0 150 VB53TC9
Variant No.	VPZBBSL	VZC3FST	V797FE6	VB53TC9
Cable cross-section	70 mm ²	95 mm ²	120 mm ²	150 mm ²
Material	Cu	Cu	Cu	Cu
Max. short-circuit current I_k 0.5 s	19.5 kA	26.5 kA	33.5 kA	42.0 kA
Max. short-circuit current I_k 1 s	13.8 kA	18.7 kA	23.7 kA	29.6 kA

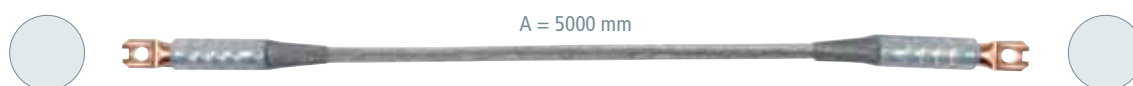

Type	EKV1+0 70 VVXDACJ
Variant No.	VVXDACJ ^{NEU}
Cable cross-section	70 mm ²
Material	Al
Max. short-circuit current I_k 0.5 s	13.0 kA
Max. short-circuit current I_k 1 s	9.2 kA

NEW

Attention: Please state the relevant Variant No. when ordering.

Two-pole Earthing and Short-Circuiting Cables

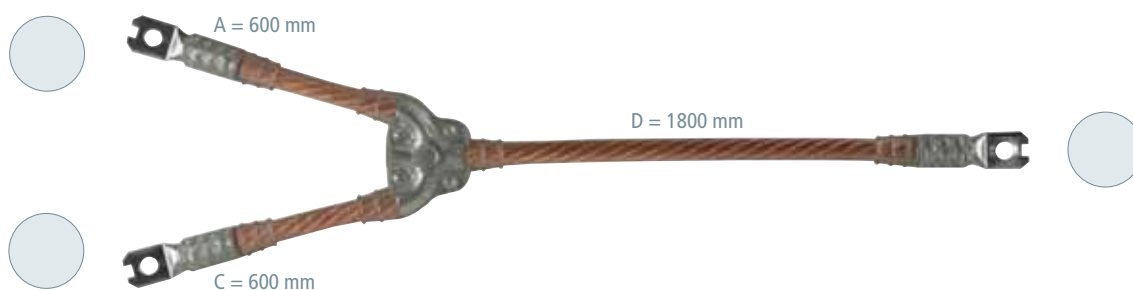

General Information:

Crimped cable lug	PK1
-------------------	-----

Type	EKV2+0 16 G V7265NS	EKV2+0 25 G VZL6TGH	EKV2+0 35 G VPHPZV2	EKV2+0 50 G VJ13VWW
Variant No.	V7265NS	VZL6TGH	VPHPZV2	VJ13VWW
Cable cross-section Cu	16 mm ²	25 mm ²	35 mm ²	50 mm ²
Max. short-circuit current I_k 0.5 s	4.5 kA	7.0 kA	10.0 kA	14.0 kA
Max. short-circuit current I_k 1 s	3.2 kA	4.9 kA	6.9 kA	9.9 kA

Type	EKV2+0 70 G VTJKEZU	EKV2+0 95 G VAM7M6H	EKV2+0 120 G V797FE6	EKV2+0 150 G VLL6JWS
Variant No.	VTJKEZU	VAM7M6H	V797FE6	VLL6JWS
Cable cross-section Cu	70 mm ²	95 mm ²	120 mm ²	150 mm ²
Max. short-circuit current I_k 0.5 s	19.5 kA	26.5 kA	33.5 kA	42.0 kA
Max. short-circuit current I_k 1 s	13.8 kA	18.7 kA	23.7 kA	29.6 kA

Attention: Please state the relevant Variant No. when ordering.

4. Carry out Earthing and Short-Circuiting – EaS Devices

Three-pole Earthing and Short-Circuiting Cables, same Cable Cross-Section

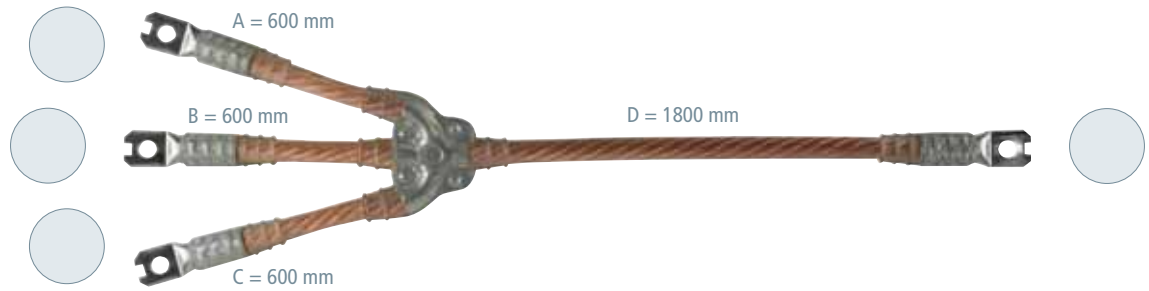

General Information:

Crimped cable lug PK1

Type	EKV3+0 16 G VE5MT89	EKV3+0 25 G VNC1S9W	EKV3+0 35 G V18JQHQ	EKV3+0 50 G VJ7VGZD
Variant No.	VE5MT89	VNC1S9W	V18JQHQ	VJ7VGZD
Cable cross-section Cu	16 mm ²	25 mm ²	35 mm ²	50 mm ²
Max. short-circuit current I _k 0.5 s	4.5 kA	7.0 kA	10.0 kA	14.0 kA
Max. short-circuit current I _k 1 s	3.2 kA	4.9 kA	6.9 kA	9.9 kA

Type	EKV3+0 70 G VH95BZZ	EKV3+0 95 G VM2J7S3	EKV3+0 120 G V8D4AQ2	EKV3+0 150 G VG3V6T2
Variant No.	VH95BZZ	VM2J7S3	V8D4AQ2	VG3V6T2
Cable cross-section Cu	70 mm ²	95 mm ²	120 mm ²	150 mm ²
Max. short-circuit current I _k 0.5 s	19.5 kA	26.5 kA	33.5 kA	42.0 kA
Max. short-circuit current I _k 1 s	13.8 kA	18.7 kA	23.7 kA	29.6 kA

Attention: Please state the relevant Variant No. when ordering.

Three-pole Earthing and Short-Circuiting Cables, reduced Cable Cross-Section

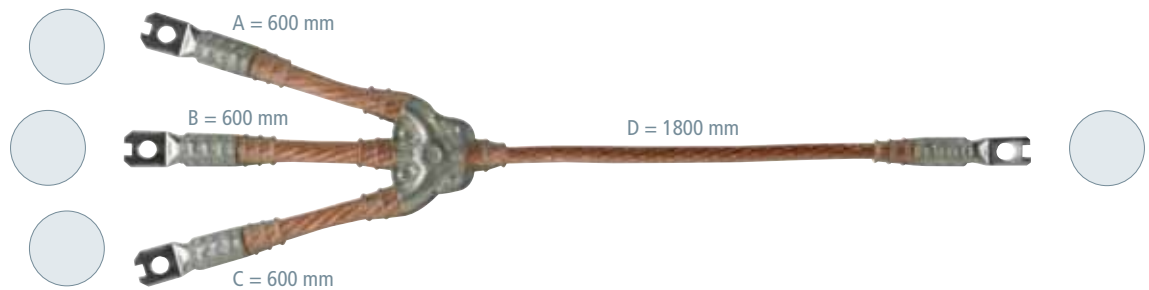

General Information:

Crimped cable lug PK1

Type	EKV3+0 50 R VN35H5D	EKV3+0 70 R VTCS2XV	EKV3+0 95 R VLB2F3G
Variant No.	VN35H5D	VTCS2XV	VLB2F3G
Cable cross-section Cu	50/25 mm ²	70/35 mm ²	95/35 mm ²
Max. short-circuit current I _k 0.5 s	14.0 kA	19.5 kA	26.5 kA
Max. short-circuit current I _k 1 s	9.9 kA	13.8 kA	18.7 kA

Type	EKV3+0 120 R V8115WA	EKV3+0 150 R V11E77B
Variant No.	V8115WA	V11E77B
Cable cross-section Cu	120/50 mm ²	150/50 mm ²
Max. short-circuit current I _k 0.5 s	33.5 kA	42.0 kA
Max. short-circuit current I _k 1 s	23.7 kA	29.6 kA

Attention: Please state the relevant Variant No. when ordering.

4. Carry out Earthing and Short-Circuiting – EaS Devices

Four-pole Earthing and Short-Circuiting Cables

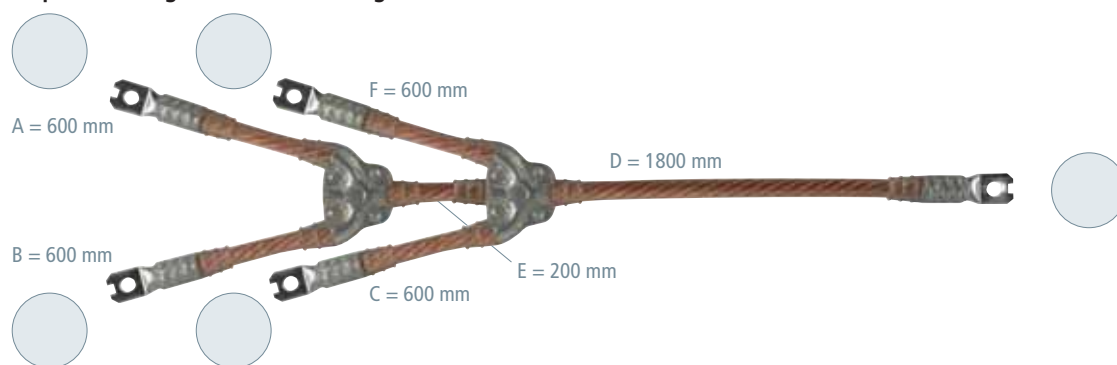

General Information:

Crimped cable lug	PK1
-------------------	-----

Type	EKV4U0 16 G VGUVRRG	EKV4U0 25 G VGM214B	EKV4U0 35 G V93UVAP	EKV4U0 50 G V3NC SHX
Variant No.	VGUVRRG	VGM214B	V93UVAP	V3NC SHX
Cable cross-section Cu	16 mm ²	25 mm ²	35 mm ²	50 mm ²
Max. short-circuit current I _k 0.5 s	4.5 kA	7.0 kA	10.0 kA	14.0 kA
Max. short-circuit current I _k 1 s	3.2 kA	4.9 kA	6.9 kA	9.9 kA

Type	EKV4U0 70 G V7GN8WU	EKV4U0 95 G VABRSSE	EKV4U0 120 G V27E2GP	EKV4U0 150 G V291ZZT
Variant No.	V7GN8WU	VABRSSE	V27E2GP	V291ZZT
Cable cross-section Cu	70 mm ²	95 mm ²	120 mm ²	150 mm ²
Max. short-circuit current I _k 0.5 s	19.5 kA	26.5 kA	33.5 kA	42.0 kA
Max. short-circuit current I _k 1 s	13.8 kA	18.7 kA	23.7 kA	29.6 kA

Attention: Please state the relevant Variant No. when ordering.

Five-pole Earthing and Short-Circuiting Cables

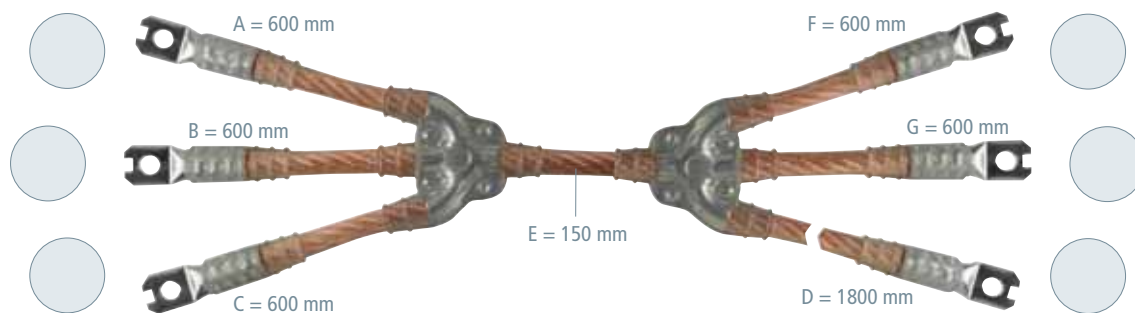

General Information:

Crimped cable lug	PK1
-------------------	-----

Type	EKV5+0 16 G VQ7PF5A	EKV5+0 25 G VZKQZB5	EKV5+0 35 G V76D5TH	EKV5+0 50 G V6VE249
Variant No.	VQ7PF5A	VZKQZB5	V76D5TH	V6VE249
Cable cross-section Cu	16 mm ²	25 mm ²	35 mm ²	50 mm ²
Max. short-circuit current I _k 0.5 s	4.5 kA	7.0 kA	10.0 kA	14.0 kA
Max. short-circuit current I _k 1 s	3.2 kA	4.9 kA	6.9 kA	9.9 kA

Type	EKV5+0 70 G VDXTBGF	EKV5+0 95 G VGCMAA5	EKV5+0 120 G VVL7AKP	EKV5+0 150 G VHV1NKR
Variant No.	VDXTBGF	VGCMAA5	VVL7AKP	VHV1NKR
Cable cross-section Cu	70 mm ²	95 mm ²	120 mm ²	150 mm ²
Max. short-circuit current I _k 0.5 s	19.5 kA	26.5 kA	33.5 kA	42.0 kA
Max. short-circuit current I _k 1 s	13.8 kA	18.7 kA	23.7 kA	29.6 kA

Attention: Please state the relevant Variant No. when ordering.

4. Carry out Earthing and Short-Circuiting – EaS Devices

Earthing Cable Cu in accordance with IEC 61138

The cable is delivered without crimped cable lugs and can be ordered by the metre.

General Information:

Minimum order quantity *)	1 m
---------------------------	-----

Type	ES YM2 16	ES YM2 25	ES YM2 35	ES YM2 50
Part No.	716 001	725 001	735 001	750 001
Cable cross-section	16 mm ²	25 mm ²	35 mm ²	50 mm ²

Type	ES YM2 70	ES YM2 95	ES YM2 120	ES YM2 150
Part No.	770 001	795 001	712 001	715 001
Cable cross-section	70 mm ²	95 mm ²	120 mm ²	150 mm ²

*) Please specify the length of the earthing cable when ordering (in whole metres)

Note:

If you have no Internet access, please fill in the template (DEHN form No. 2151) and send it to us!



4. Carry out Earthing and Short-Circuiting – EaS Devices

Phase Connecting Elements for Switchgear Installations

- To be fitted to the phase cable end of single-pole to five-pole earthing and short-circuiting devices
- Anti-rotation element PK1
- Other earthing and short-circuiting devices can be configured online via the earthing and short-circuiting configurator



General Information:

Standard	EN/IEC 61230 (DIN VDE 0683-100), threaded T pin shaft DIN 48087
Temperature range	-25 °C ... +55 °C
Material (clamp body)	Cu alloy/gal Sn
Material (terminal lug)	Cu alloy/gal Sn
Material (shaft)	Cu alloy/gal Sn
Material (pressure plate)	Cu alloy/gal Sn / St/Zn



Connecting the phase cable end with universal clamp to a fixed ball point



SK: Hexagon shaft

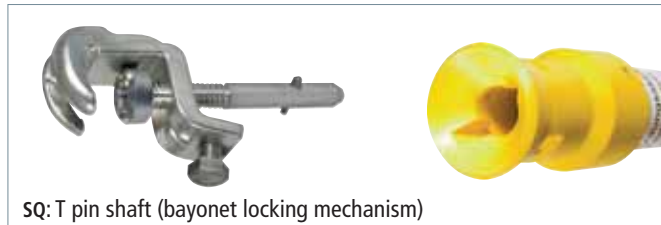

SQ: T pin shaft (bayonet locking mechanism)

Two types of ball head caps are available:

- Rigid ball head cap
- Adjustable ball head cap (4x 90°)

The adjustable ball head cap allows the user to connect the earthing and short-circuiting device to fixed ball points that are installed in unfavourable positions. Thus, in the vast majority of cases, angled fixed ball points no longer have to be used.



Rigid ball head cap



Adjustable ball head cap (4x 90°)



Rigid Ball Head Cap, Hexagon Shaft

Type	KKH 20 SK	KKH 25 SK
Part No.	772 310	772 320
For fixed ball point Ø	20 mm	25 mm
Anti-rotation element	PK1	PK1
For cable cross-section Cu	16 ... 120 mm ²	16 ... 150 mm ²
Max. short-circuit current I _k 0.5 s	33.5 kA	42.0 kA
Max. short-circuit current I _k 1 s	23.7 kA	29.6 kA



Rigid Ball Head Cap, T Pin Shaft

Type	KKH 20 SQ	KKH 25 SQ
Part No.	772 311	772 321
For fixed ball point Ø	20 mm	25 mm
Anti-rotation element	PK1	PK1
For cable cross-section Cu	16 ... 120 mm ²	16 ... 150 mm ²
Max. short-circuit current I _k 0.5 s	33.5 kA	42.0 kA
Max. short-circuit current I _k 1 s	23.7 kA	29.6 kA



4. Carry out Earthing and Short-Circuiting – EaS Devices

Adjustable Ball Head Cap (4x 90°), Hexagon Shaft



Type	KKH 20 D SK	KKH 25 D SK
Part No.	772 330	772 340
For fixed ball point Ø	20 mm	25 mm
Anti-rotation element	PK1	PK1
For cable cross-section Cu	16 ... 120 mm ²	16 ... 150 mm ²
Max. short-circuit current I _k 0.5 s	33.5 kA	42.0 kA
Max. short-circuit current I _k 1 s	23.7 kA	29.6 kA

Adjustable Ball Head Cap (4x 90°), T Pin Shaft



Type	KKH 20 D SQ	KKH 25 D SQ
Part No.	772 331	772 341
For fixed ball point Ø	20 mm	25 mm
Anti-rotation element	PK1	PK1
For cable cross-section Cu	16 ... 120 mm ²	16 ... 150 mm ²
Max. short-circuit current I _k 0.5 s	33.5 kA	42.0 kA
Max. short-circuit current I _k 1 s	23.7 kA	29.6 kA

Round Pin Clamp, T Pin Shaft

For round pins in switchgear installations.



Type	RBK 35 SQ
Part No.	715 312
For round pins Ø	35 mm
Anti-rotation element	PK1
For cable cross-section Cu	16 ... 150 mm ²
Max. short-circuit current I _k 0.5 s	42.0 kA
Max. short-circuit current I _k 1 s	29.6 kA

Universal Clamp, Hexagon Shaft



Type	UK 25 SK	UK 30 SK
Part No.	773 034	773 130
For fixed ball point Ø	20 / 25 mm	25 / 30 mm
For T pins with a collar width of	15 mm	18 mm
Rd / Fl clamping range	20 mm	30 mm
Anti-rotation element	PK1	PK1
For cable cross-section Cu	16 ... 120 ^{*)} mm ²	16 ... 120 ^{*)} mm ²
Max. short-circuit current I _k 0.5 s	33.5 kA	33.5 kA
Max. short-circuit current I _k 1 s	23.7 kA	23.7 kA

^{*)} See table for "Clamping range and maximum cable cross-section of universal clamps used for"

Universal Clamp, T pin shaft



Type	UK 25 SQ	UK 30 SQ
Part No.	773 234	773 330
For fixed ball point Ø	20 / 25 mm	25 / 30 mm
For T pins with a collar width of	15 mm	18 mm
Rd / Fl clamping range	20 mm	30 mm
Anti-rotation element	PK1	PK1
For cable cross-section Cu	16 ... 120 ^{*)} mm ²	16 ... 120 ^{*)} mm ²
Max. short-circuit current I _k 0.5 s	33.5 kA	33.5 kA
Max. short-circuit current I _k 1 s	23.7 kA	23.7 kA

^{*)} See table for "Clamping range and maximum cable cross-section of universal clamps used for"

Phase Connecting Element, T Pin Shaft

With M16 threaded pin for installation in switchgear installations.



Type	PAS EK SQ 16
Part No.	771 316
Dimensions	M16
Anti-rotation element	PK1
For cable cross-section Cu	16 ... 150 mm ²
Max. short-circuit current I _k 0.5 s	42.0 kA
Max. short-circuit current I _k 1 s	29.6 kA

^{*)} Clamping range and maximum cable cross-section of universal clamps used for:

Fixed ball point Ø	T Pin Collar width	Rd / Fl Clamping range	Max. cable cross-section
20 / 25 / 30 mm	15 / 18 mm	20 / 30 mm	16 mm ²
20 / 25 / 30 mm	15 / 18 mm	20 / 30 mm	25 mm ²
20 / 25 / 30 mm	15 / 18 mm	20 / 30 mm	35 mm ²
20 / 25 / 30 mm	15 / 18 mm	20 / 30 mm	50 mm ²
20 / 25 / 30 mm	15 / 18 mm	20 / 30 mm	70 mm ²
20 / 25 / 30 mm	15 / 18 mm	—	95 mm ²
— / 25 / 30 mm	—	—	120 mm ²
—	—	—	150 mm ²

The clamps must have the same maximum short-circuit current as the earthing and short-circuiting cables!

Detailed product information: www.dehn-international.com/search

Valid as of January 1, 2016

4. Carry out Earthing and Short-Circuiting – EaS Devices

Phase Connecting Elements for Overhead Lines

- For connecting the phase cables of single-pole and three-pole earthing and short-circuiting devices to overhead lines
- With coupling aid for safe attachment on conductor cables
- Easy coupling due to spring-loaded clamp
- Anti-rotation element PK1 or PK2 and long threaded T pin shaft
- Earthing and short-circuiting devices can be configured online via the earthing and short-circuiting configurator



General Information:

Standard	EN/IEC 61230 (DIN VDE 0683-100), threaded T pin shaft DIN 48087
Temperature range	-25 °C ... +55 °C
Material (pressure plate)	Aluminium alloy
Material (clamp body)	Aluminium alloy
Material (shaft)	Copper alloy/gal Sn or StSt
Material (coupling aid)	St/gal Zn



Phase screw clamps used on an overhead line

Crimped cable lug, type PK1:
Standard anti-rotation cable lug with cut-out.Crimped cable lug, type PK2:
Cable lugs without cut-out for connecting parts from other manufacturers are available on request.

Clamp with long shaft and earthing stick with aluminium cone coupling

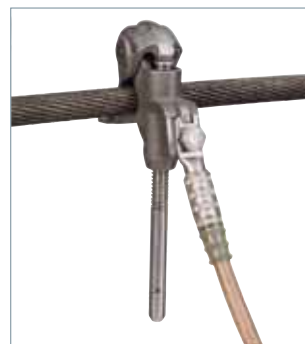

Spring-loaded phase screw clamp



Phase screw clamp fitted with fixed coupling aid allows safe coupling

Standard Phase Screw Clamp

Short-circuit-proof, even if the conductor cables are corroded due to weathering.

Type	PSK 4 30 SQL	PSK 10 65 SQL
Part No.	784 201	784 301
Clamping range Ø	4 ... 30 mm	10 ... 65 mm
Anti-rotation element	PK1	PK1
For cable cross-section Cu	16 ... 70 mm ²	16 ... 120 mm ²
Max. short-circuit current I _k 0.5 s	19.5 kA	33.5 kA
Max. short-circuit current I _k 1 s	13.8 kA	23.7 kA

Phase Screw Clamp with Coupling Aid

Short-circuit-proof, even if the conductor cables are corroded due to weathering.

Type	PSK 4 30 SQL EH	PSK 10 65 SQL EH
Part No.	784 401	784 501
Clamping range Ø	4 ... 30 mm	10 ... 65 mm
Anti-rotation element	PK1	PK1
For cable cross-section Cu	16 ... 70 mm ²	16 ... 120 mm ²
Max. short-circuit current I _k 0.5 s	19.5 kA	33.5 kA
Max. short-circuit current I _k 1 s	13.8 kA	23.7 kA



4. Carry out Earthing and Short-Circuiting – EaS Devices

**Spring-loaded Phase Screw Clamp**

Easy coupling due to spring-loaded clamp.

Type	PSK FV 4 30 SQL
Part No.	784 480
Clamping range Ø	4 ... 30 mm
Anti-rotation element	PK1
For cable cross-section Cu	16 ... 70 mm ²
Max. short-circuit current I _k 0.5 s	19.5 kA
Max. short-circuit current I _k 1 s	13.8 kA

**Phase Screw Clamp with wide Clamping Range**

Ideally suited for use with Al and Al/St conductor cables, pipes and fixed phase points.

Type	PSK 10 85 SQL
Part No.	784 085
Clamping range Ø	10 ... 85 mm
Anti-rotation element	PK2
For cable cross-section Cu	16 ... 150 mm ²
Max. short-circuit current I _k 0.5 s	29.6 kA
Max. short-circuit current I _k 1 s	29.6 kA

**Phase Screw Clamp**

Ideally suited for use in inclined positions.

Type	PSK 10 32 SQL
Part No.	784 032
Clamping range Ø	10 ... 32 mm
Anti-rotation element	PK2
For cable cross-section Cu	16 ... 95 mm ²
Max. short-circuit current I _k 0.5 s	18.7 kA
Max. short-circuit current I _k 1 s	18.7 kA

**Phase Screw Clamp with Safety Bow**

Ideally suited for use in inclined positions.

Type	PSK 10 32 SQL SB
Part No.	784 038
Clamping range Ø	10 ... 32 mm
Anti-rotation element	PK2
For cable cross-section Cu	16 ... 95 mm ²
Max. short-circuit current I _k 0.5 s	18.7 kA
Max. short-circuit current I _k 1 s	18.7 kA

**Rigid Ball Head Cap**

Type	KKH 20 SQL	KKH 25 SQL
Part No.	772 314	772 324
For fixed ball point Ø	20 mm	25 mm
Anti-rotation element	PK1	PK1
For cable cross-section Cu	16 ... 120 mm ²	16 ... 150 mm ²
Max. short-circuit current I _k 0.5 s	33.5 kA	42.0 kA
Max. short-circuit current I _k 1 s	23.7 kA	29.6 kA

**Universal Clamp**

Type	UK 25 SQL	UK 30 SQL
Part No.	773 236	773 331
For fixed ball point Ø	20 / 25 mm	25 / 30 mm
For T pins with a collar width of	15 mm	18 mm
Rd / Fl clamping range	20 mm	30 mm
Anti-rotation element	PK1	PK1
For cable cross-section Cu	16 ... 120 ^{*)} mm ²	16 ... 120 ^{*)} mm ²
Max. short-circuit current I _k 0.5 s	33.5 kA	33.5 kA
Max. short-circuit current I _k 1 s	23.7 kA	23.7 kA

^{*)} See table page 72 for "Clamping range and maximum cable cross-section of universal clamps used for"

4. Carry out Earthing and Short-Circuiting – EaS Devices

Spring-Loaded Phase Clamp

Spring-loaded clamp for overhead lines without shaft.

Single-pole or three-pole coupling aid for easy coupling and removal of the clamp, the spring-loaded clamp is connected by simply removing the coupling aid.

Type	PK FV 4 25
Part No.	784 490
Clamping range \varnothing	4 ... 25 mm
Anti-rotation element	PK1 / PK1
For cable cross-section Cu	16 ... 70 mm ²
Max. short-circuit current I_k 0.5 s	13.8 kA
Max. short-circuit current I_k 1 s	13.8 kA



Accessories for Spring-Loaded Phase Clamp

Single-pole Coupling Aid with Gear Coupling

For ISMTC N 36 ZK 10600 telescopic sticks for use from the ground.

Type	EH1 PK FV ZK
Part No.	784 461
Total length	520 mm



Three-pole Coupling Aid with T Pin Shaft

For earthing sticks with bayonet locking mechanism for use from towers or mobile elevating working platforms.

Type	EH3 PK FV SQL
Part No.	784 463
Total length	500 mm

The clamps must have the same maximum short-circuit current as the earthing and short-circuiting cables!

Accessories for Phase Connecting Elements for Overhead Lines

Two-pole Phase Connecting Plate

Allows to connect two phase screw clamps with PK1 anti-rotation element.

Type	PAP 2 M12 SSM B13
Part No.	728 312
Anti-rotation cable lug	PK1
Borehole	\varnothing 12.5 mm
Max. short-circuit current I_k 0.5 s	33.5 kA
Max. short-circuit current I_k 1 s	23.7 kA



Three-pole Phase Connecting Plate with Round Pin

Phase connecting plate for phase clamps.

Type	PAP 3 M12 SSM B13 RB
Part No.	728 313
Anti-rotation cable lug	PK1
Borehole	\varnothing 12.5 mm mm
Max. short-circuit current I_k 0.5 s	33.5 kA
Max. short-circuit current I_k 1 s	23.7 kA

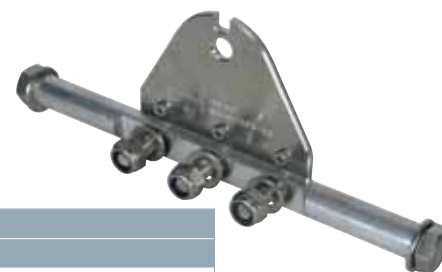

4. Carry out Earthing and Short-Circuiting – EaS Devices

Phase Connecting Elements for Railway Applications



- Safe positive-locking earth clamps for railway applications



Coupling the earth clamp to the overhead contact line.



Earth Clamp for Overhead Contact Lines

With contact electrode and flexible threaded T pin shaft according to DIN 48087.
For AC-80 to AC-120 overhead contact lines.

Type	FEK 4 15 TS FSQL	FEK4 15 TS FSQL AB29
Part No.	784 755	784 756 ^{NEW}
Clamping range Ø	4 ... 15 mm	4 ... 15 mm
Anti-rotation cable lug	PK2 (Ø10.5 mm)	PK2 (Ø10.5 mm)
For cable material	Cu	Al
For cable cross-section	50 mm ²	70 mm ²
DB drawing No.	3 Ebgw 01.54	Ebgw 01.85
DB material No.	157 536	—



Conductor Clamp

With contact electrode and threaded T pin shaft according to DIN 48087.
For supply and traction power lines.

Type	LK 4 40 TS SQL
Part No.	784 352
Clamping range Ø	4 ... 40 mm
Anti-rotation cable lug	PK2 (Ø10.5 mm)
DB drawing No.	3 Ebgw 01.65
DB material No.	157 539

4. Carry out Earthing and Short-Circuiting – EaS Devices

Earthing Kit

- For overhead line systems
- For driving the tubular earth electrode into the ground
- Kit consists of a tubular earth electrode with drill, 3-pole earthing busbar and transport bag

General Information:

Material (tubular earth electrode)	St/tZn
Material (bolt)	StSt (V2A)
Material (handle)	Wood
Material (earthing busbar)	St/tZn

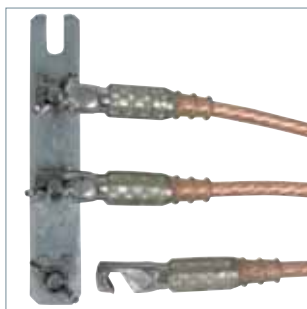

Earthing busbar and earthing cables mounted on a tubular earth electrode

Crimped cable lugs, type PK3:
Anti-rotation hook-type cable lug mounted on a three-pole earthing busbar.

Earthing Kit

For three-pole earthing devices.

Type	ES 3P FL ER
Part No.	799 009
Total length (l _G)	1000 mm
Bolt	M10 x 35 mm

Kit includes:

Pos.	Part No.	Pos.	Part No.
1	644 000	3	766 601
2	799 019		

More details on the bag, see chapter storage bags and transport cases.

Accessories for Earthing Kit

Tubular Earth Electrode with Drill

Type	ERO BSP ASSM10 1000 STTZN
Part No.	644 000
Length (drill)	1000 mm
Military Name	VG 96953 T10 A0001
Stock No.	5975-12-120-0006



Three-pole Earthing Busbar

With slot for mounting the earthing busbar on the tubular earth electrode, for hook-type cable lugs of type PK3.

Type	ESS 3P M10 FM
Part No.	799 019
Dimensions	180 x 30 x 5 mm
Bolt	3x M10 x 35 mm



4. Carry out Earthing and Short-Circuiting – EaS Devices

Earth Spike



Earth spike with coiled earthing cable.

- To be driven into the soil
- Two half-shells for earthing or extension cables
- Hot-dip galvanised version

General Information:

Material	St/tZn
Material (bolt)	St/St



Earth Spike

With M12 connection bolt.

Type	ESP HVS 1500
Part No.	799 006
Total length (l _G)	1500 mm
Bolt	M12 x 25 mm

Earth Connecting Elements for Switchgear Installations and Overhead Lines



Universal earth clamp with handle connected to a fixed ball point

Clamping Range up to 40 mm

- For connecting the earth cable end to fixed ball points, T pins, round and flat conductors, connecting elements and flat profiles
- For wide clamping ranges up to 40 mm
- Anti-rotation element of type PK1 or PK2
- Earthing and short-circuiting devices can be configured online by means of the earthing and short-circuiting configurator



General Information:

Standard	EN/IEC 61230 (DIN VDE 0683-100)
Temperature range	-25 °C ... +55 °C
Material (clamp body)	Cu alloy/gal Sn / MCl/gal Zn
Material (shaft)	Cu alloy/gal Sn / brass/gal Zn
Material (pressure plate)	Cu alloy/gal Sn / St/gal Zn
Material (terminal lug)	E-Cu/gal Sn
Material (wing nut)	Cu alloy/gal Sn
Material (milling plate)	St, hardened / chromed
Material (spring)	Spring steel

4. Carry out Earthing and Short-Circuiting – EaS Devices

Universal Clamp with Wing Bolt

Type	UEK 25 FS	UEK 30 FS
Part No.	774 034	774 130
For fixed ball point Ø	20 / 25 mm	25 / 30 mm
For T pins with a collar width of	15 mm	18 mm
Rd / Fl clamping range	20 mm	30 mm
Anti-rotation cable lug	PK1	PK1
For cable cross-section Cu	16 ... 120 ^{*)} mm ²	16 ... 120 ^{*)} mm ²
Max. short-circuit current I _k 0.5 s	33.5 kA	33.5 kA
Max. short-circuit current I _k 1 s	23.7 kA	23.7 kA



^{*)} See table page 72 for "Clamping range and maximum cable cross-section of universal clamps used for"

Universal Clamp with Handle

Type	UEK 25 HG	UEK 30 HG
Part No.	774 234	774 330
For fixed ball point Ø	20 / 25 mm	25 / 30 mm
For T pins with a collar width of	15 mm	18 mm
Rd / Fl clamping range	20 mm	30 mm
Anti-rotation cable lug	PK1	PK1
For cable cross-section Cu	16 ... 120 ^{*)} mm ²	16 ... 120 ^{*)} mm ²
Max. short-circuit current I _k 0.5 s	33.5 kA	33.5 kA
Max. short-circuit current I _k 1 s	23.7 kA	23.7 kA



^{*)} See table page 72 for "Clamping range and maximum cable cross-section of universal clamps used for"

Universal Clamp with Tommy Bar

Type	UEK 25 SKN	UEK 30 SKN
Part No.	774 434	774 530
For fixed ball point Ø	20 / 25 mm	30 mm
For T pins with a collar width of	15 mm	18 mm
Rd / Fl clamping range	20 mm	30 mm
Anti-rotation cable lug	PK1	PK1
For cable cross-section Cu	16 ... 120 ^{*)} mm ²	16 ... 120 ^{*)} mm ²
Max. short-circuit current I _k 0.5 s	33.5 kA	33.5 kA
Max. short-circuit current I _k 1 s	23.7 kA	23.7 kA



^{*)} See table page 72 for "Clamping range and maximum cable cross-section of universal clamps used for"

Rigid Ball Head Cap with Wing Bolt

Type	KKH 20 FS	KKH 25 FS
Part No.	772 312	772 322
For fixed ball point Ø	20 mm	25 mm
Anti-rotation cable lug	PK1	PK1
For cable cross-section Cu	16 ... 120 mm ²	16 ... 150 mm ²
Max. short-circuit current I _k 0.5 s	33.5 kA	42.0 kA
Max. short-circuit current I _k 1 s	23.7 kA	29.6 kA



Rigid Ball Head Cap with Handle

Type	KKH 20 HG	KKH 25 HG
Part No.	772 313	772 323
For fixed ball point Ø	20 mm	25 mm
Anti-rotation cable lug	PK1	PK1
For cable cross-section Cu	16 ... 120 mm ²	16 ... 150 mm ²
Max. short-circuit current I _k 0.5 s	33.5 kA	42.0 kA
Max. short-circuit current I _k 1 s	23.7 kA	29.6 kA



4. Carry out Earthing and Short-Circuiting – EaS Devices

Earth Connecting Element with Wing Nut



Type	EAS EK FM 12	EAS EK FM 16
Part No.	775 621	775 631
Dimensions	M12	M16
Anti-rotation cable lug	PK1	PK1
For cable cross-section Cu	16 ... 150 mm ²	16 ... 150 mm ²
Max. short-circuit current I _k 0.5 s	42.0 kA	42.0 kA
Max. short-circuit current I _k 1 s	29.6 kA	29.6 kA

Earth Connecting Element with Wing Bolt



Type	EAS EK FS 12	EAS EK FS 16
Part No.	775 626	775 636
Dimensions	M12 x 15 mm	M16 x 15 mm
Anti-rotation cable lug	PK1	PK1
For cable cross-section Cu	16 ... 150 mm ²	16 ... 150 mm ²
Max. short-circuit current I _k 0.5 s	42.0 kA	42.0 kA
Max. short-circuit current I _k 1 s	29.6 kA	29.6 kA

Earth Bushing with Wing Bolt

For fixed earthing points with ring groove



Type	EAB RN 16 FS
Part No.	790 150
Dimensions	Ø16 mm
Anti-rotation cable lug	PK1
For cable cross-section Cu	16 ... 150 ^{*)} mm ²
Max. short-circuit current I _k 0.5 s	42.0 kA
Max. short-circuit current I _k 1 s	29.6 kA

^{*)} For cable lengths > 4000 mm: max. up to 95 mm² (26.5 kA / 0.5 s).

Earth Bushing with Tommy Bar

For fixed earthing points with ring groove



Type	EAB RN 16 SKN
Part No.	790 160
Dimensions	Ø16 mm
Anti-rotation cable lug	PK2
For cable cross-section Cu	16 ... 150 ^{**)} mm ²
Max. short-circuit current I _k 0.5 s	29.6 kA
Max. short-circuit current I _k 1 s	29.6 kA

^{**)} Max. short-circuit current of 29.6 kA even in case of a disconnection time I_k of 1 s.

Earth Milling Clamp with Tommy Bar and Disc Springs

Milling plate, disc springs and long tommy bar for reliable contact



Type	EFK FL40 SKN
Part No.	792 190
Clamping range	up to 40 mm
Anti-rotation cable lug	PK1
For cable cross-section Cu	25 ... 95 mm ²
Max. short-circuit current I _k 0.5 s	26.5 kA
Max. short-circuit current I _k 1 s	18.7 kA

Earth Milling Clamp with Tommy Bar

Milling plate, disc springs and long tommy bar for reliable contact



Type	EFK FL30 SKN
Part No.	792 030
Clamping range	Up to 30 mm
Anti-rotation cable lug	PK1
For cable cross-section Cu	25 ... 50 mm ²
Max. short-circuit current I _k 0.5 s	14.0 kA
Max. short-circuit current I _k 1 s	9.9 kA

The clamps must have the same maximum short-circuit current as the earthing and short-circuiting cables!

4. Carry out Earthing and Short-Circuiting – EaS Devices

Earth Connecting Elements for Railway Applications

- Safe earth connection elements for railway applications



Clamp for railway tracks mounted at the track profile.

Clamp for Railway Tracks with Tommy Bar

With detachable tommy bar (locking spring).

For profile-free earthing of track profiles S49, S54, S64 and UIC60.

Type	SAK PFE KN	SAK PFE KN AB29
Part No.	792 450	792 451 ^{NEW}
Anti-rotation cable lug	PK2 (Ø10.5 mm)	PK2 (Ø10.5 mm)
Cable material	Cu	Al
For cable cross-section	50 mm ²	70 mm ²
Max. short-circuit current I_k 0.06 s	34.0 kA	32.0 kA
DB drawing No.	3 Ebgw 01.53	Ebgw 01.82
DB material No.	157 535	—



Clamp for Railway Tracks with Ratchet

With detachable ratchet.

For profile-free earthing of track profiles S49, S54, S64 and UIC60.

Type	SAK PFE RA	SAK PFE RA AB29
Part No.	792 453	792 454 ^{NEW}
Anti-rotation cable lug	PK2 (Ø10.5 mm)	PK2 (Ø10.5 mm)
Cable material	Cu	Al
For cable cross-section	50 mm ²	70 mm ²
Max. short-circuit current I_k 0.06 s	34.0 kA	32.0 kA
DB drawing No.	3 Ebgw 01.53	Ebgw 01.83
DB material No.	157 549	—



Universal Clamp, T Pin Shaft

T pin according to DIN 48087.

Type	UK K25 FL30 SQL
Part No.	773 251
For fixed ball point Ø	25 / 30 mm
Anti-rotation cable lug	PK2 (Ø10.5 mm)
For cable cross section Cu	50 mm ²
Max. short-circuit current I_k 0.06 s	34.0 kA
DB drawing No.	4 Ebgw 01.59
DB material No.	157 538



Universal Clamp with Handle

Type	UK K25 FL30 HG
Part No.	774 251
For fixed ball point Ø	25 / 30 mm
Anti-rotation cable lug	PK2 (Ø10.5 mm)
For cable cross section Cu	50 mm ²
Max. short-circuit current I_k 0.06 s	34.0 kA
DB drawing No.	4 Ebgw 01.64
DB material No.	157 537



4. Carry out Earthing and Short-Circuiting – EaS Devices

Earthing Sticks for Switchgear Installations



- For attaching earthing and short-circuiting devices
- Available in different lengths
- Modular for easy transport
- Light-weight construction
- Hexagon shaft (width across flats 19 mm) or T pin shaft



General Information:

Standard	T pin shaft DIN 48087
Temperature range	-25 °C ... +55 °C
Material (insulating tube)	Glass-fibre reinforced polyester tube
End fitting	Non-slip plastic cap or plug-in coupling for extending the handle

Earthing stick used for attaching an earthing and short-circuiting device to an installation.



Earthing sticks with bayonet locking mechanism (T pin shaft) can also be used for clamps with hexagon shafts by attaching an AES SQ SK adapter.



The plug-in coupling allows for easy handle extension of ES STK earthing sticks.

Earthing sticks are hand-held insulating sticks for approaching clamps of earthing and short-circuiting devices to parts of electrical installations for earthing and short-circuiting purposes.

They consist of an insulating element, black ring, handle and coupling for attaching clamps. Earthing sticks have to be selected according to the **weight** of the earthing and short-circuiting device (see also "max. load on the operating head in kg").

The **insulating element** is the part of the earthing stick between the black ring and the end of the earthing stick in the direction of the clamp. It ensures that the user maintains the required safety distance and provides sufficient insulation. In installations exceeding 1 kV, the insulating element must have a minimum length of 500 mm.

For Hexagon Shafts

Handle termination with end cap (spring locking mechanism)

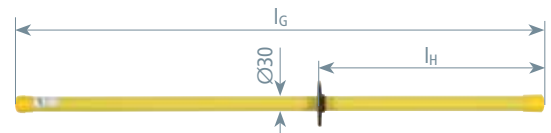

Type	ES SK 1000	ES SK 1500
Part No.	761 010	761 015
Total length (l_G)	1000 mm	1500 mm
Length (handle) (l_H)	430 mm	930 mm
Max. load on the operating head	35 kg	35 kg



For T Pin Shafts

Handle termination with end cap (bayonet locking mechanism)

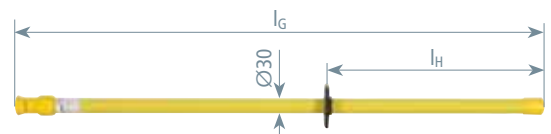

Type	ES SQ 1000	ES SQ 1500
Part No.	761 011	761 016
Total length (l_G)	1000 mm	1500 mm
Length (handle) (l_H)	430 mm	930 mm
Max. load on the operating head	35 kg	35 kg



4. Carry out Earthing and Short-Circuiting – EaS Devices

For Hexagon Shafts, Plug-in Coupling

Handle termination with plastic plug-in coupling for extending the handle (spring locking mechanism)

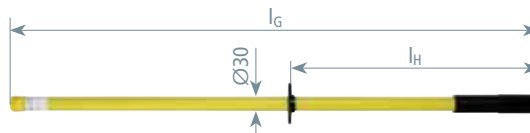

Type	ES SK STK 1000	ES SK STK 2000
Part No.	761 001	761 003
Total length (l_G)	1000 mm	2000 mm
Length (handle) (l_H)	430 mm	1430 mm
Max. load on the operating head	35 kg	20 kg



For T Pin Shafts, Plug-in Coupling

Handle termination with plastic plug-in coupling for extending the handle (bayonet locking mechanism)

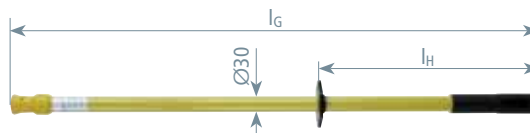

Type	ES SQ STK 1000	ES SQ STK 2000
Part No.	761 002	761 004
Total length (l_G)	1000 mm	2000 mm
Length (handle) (l_H)	430 mm	1430 mm
Max. load on the operating head	35 kg	20 kg



Two-part, for Hexagon Shafts

Handle termination with plastic plug-in coupling for extending the handle (spring locking mechanism)

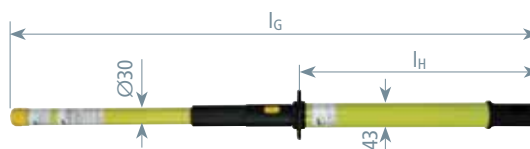

Type	EST SK STK 920
Part No.	761 070
Total length (l_G)	920 mm
Length (handle) (l_H)	415 mm
Max. load on the operating head	35 kg



Two-part, for T Pin Shafts

Handle termination with plastic plug-in coupling for extending the handle (bayonet locking mechanism)

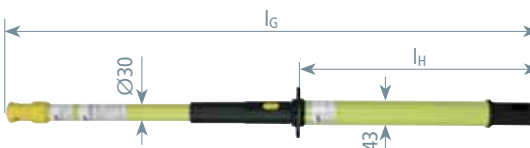

Type	EST SQ STK 920
Part No.	761 075
Total length (l_G)	920 mm
Length (handle) (l_H)	415 mm
Max. load on the operating head	35 kg



Accessories for Earthing Sticks for Switchgear Installations

Adapter (T Pin Shaft / Hexagon Shaft)

Suitable for insertion into earthing sticks with coupling for T pin shafts (bayonet locking mechanism) to accept clamps with hexagon shaft. The lock nut allows to fix the adapter on the earthing stick.

Type	AD ES SQ SK
Part No.	765 001
Length	130 mm



Adapter (T Pin Shaft / long T Pin Shaft)

Suitable for insertion into earthing sticks with aluminium cone coupling for T pin shafts (bayonet locking mechanism) to accept clamps with T pin shaft.

The lock nut allows to fix the adapter on the earthing stick.

Type	AD ES SQ SQL
Part No.	765 006
Length	185 mm



4. Carry out Earthing and Short-Circuiting – EaS Devices

Earthing Sticks for Overhead Lines



Telescopic earthing stick with aluminium cone coupling and phase screw clamp.

- For outdoor use
- Robust aluminium cone coupling
- Total lengths up to 6000 mm
- Length of telescopic stick continuously adjustable via star knob
- For phase screw clamps and clamps with long T pin shaft



General Information:

Temperature range	-25 °C ... +55 °C
Material (insulating tube)	Glass-fibre reinforced polyester tube
Material (threaded coupling, star knob)	Aluminium alloy
End fitting	Aluminium/rubber eye / Plug-in coupling for extending the handle

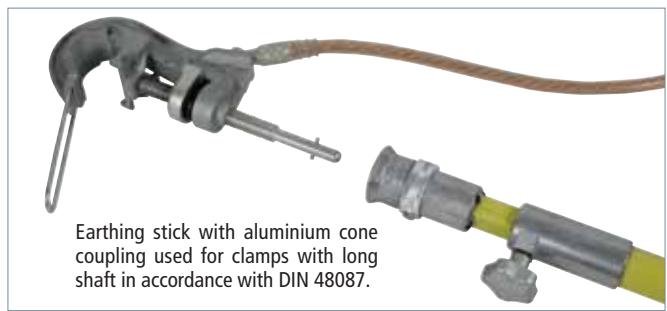

Earthing stick with aluminium cone coupling used for clamps with long shaft in accordance with DIN 48087.



Robust aluminium threaded coupling allows positive and non-positive connection due to the screw connection and gearing.



End fitting with eye (Al/rubber) or plug-in coupling with eye (Al/rubber) for extending the handle.



Lockable adjusting ring

The adjusting ring on the cone has the following functions:

- Position "AUF" (= OPEN): Stick can be removed after the clamp has been attached
- Position "ZU" (= CLOSED): Stick and clamp remain coupled even after the earthing and short-circuiting device has been attached

A square tube (26 mm) can be pulled out of the round insulating tube and can be fixed in any position between I_{\min} and I_{\max} using the star knob.

4. Carry out Earthing and Short-Circuiting – EaS Devices

Telescopic, for T Pin Shafts

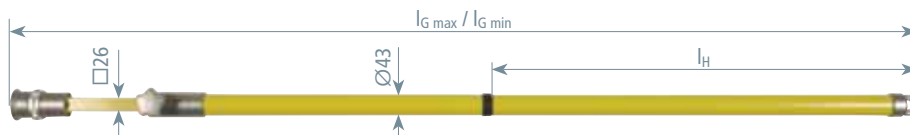

Type	ESTC SQL 4000	ESTC SQL 5000
Part No.	769 400	769 500
Total length ($l_{G \max} / l_{G \min}$)	4015 / 2180 mm	5015 / 2680 mm
Length (handle) (l_H)	1400 mm	1900 mm
Max. load on the operating head ($l_{G \max} / l_{G \min}$)	12 / 35 kg	10 / 35 kg
Diameter	43 mm	43 mm

Telescopic, for T Pin Shafts, Plug-in Coupling

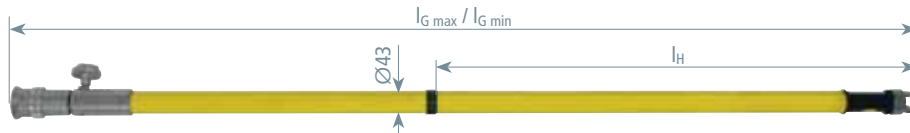

Type	ESTC SQL STK 3000
Part No.	769 300
Total length ($l_{G \max} / l_{G \min}$)	2945 / 1615 mm
Length (handle) (l_H)	900 mm
Max. load on the operating head ($l_{G \max} / l_{G \min}$)	18 / 35 kg
Diameter	43 mm

Multi-part, Top Section

With aluminium bayonet coupling and aluminium threaded coupling as end fitting.

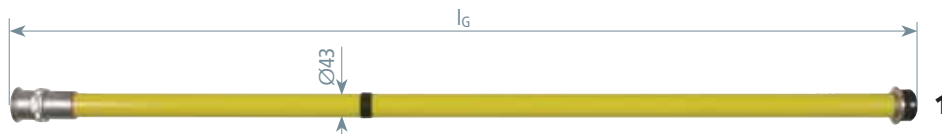

Type	EST KS SQL 1500
Part No.	769 503
Total length (l_G)	1600 mm
Diameter	43 mm

Permissible loads for the earthing sticks:		
Length l_G	Pos. No.	Max. load on the operating head
6000 mm	1+2+2+3	8 kg
4500 mm	1+2+3	15 kg
3000 mm	1+3	30 kg
1500 mm	1	35 kg

Multi-part, Intermediate Section

With aluminium threaded coupling, connector with nut and bushing.

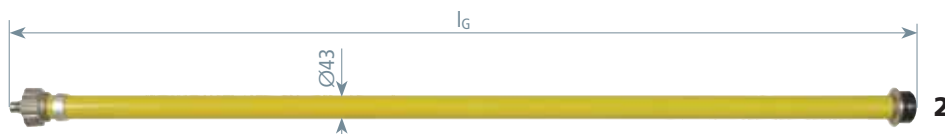

Type	EST ZS 1500
Part No.	769 504
Total length (l_G)	1580 mm
Diameter	43 mm

Multi-part, End Fitting

With connector and nut of the aluminium threaded coupling and end fitting with ring eye.

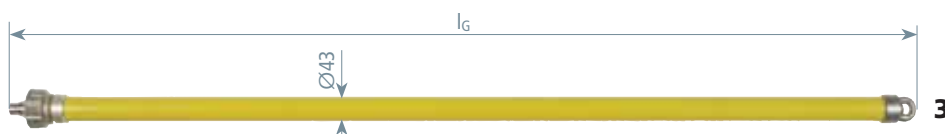

Type	EST ES 1500
Part No.	769 505
Total length (l_G)	1590 mm
Diameter	43 mm

4. Carry out Earthing and Short-Circuiting – EaS Devices

Earthing Sticks for Railway Applications



Attaching a railway earthing device.

For threaded T pin shafts (bayonet locking mechanism)

- For outdoor use
- Robust aluminium cone coupling
- Length of telescopic stick continuously adjustable via star knob
- Only suitable for phase screw clamps and clamps with long T pin shaft



General Information:

Standard	EN/IEC 61230 (DIN VDE 0683-100)
Temperature range	-25 °C ... +55 °C



Lockable adjusting ring

The adjusting ring on the cone has the following functions:

- Position "AUF" (= OPEN): Stick can be removed after the clamp has been attached
- Position "ZU" (= CLOSED): Stick and clamp remain coupled even after the earthing and short-circuiting device has been attached

Telescopic Earthing Stick for T Pin Shafts

For threaded T pin shafts (bayonet locking mechanism).

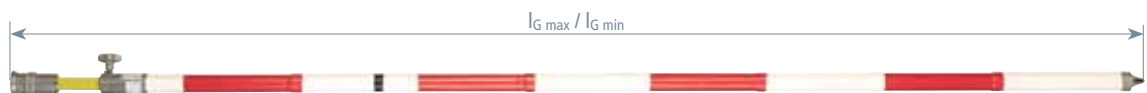

Type	ESTC SQL RW 3500	ESTC SQL RW 5000
Part No.	769 352	769 502
Total length (l _{G max} / l _{G min})	3515 / 1935 mm	5015 / 2685 mm
Max. load on the operating head (l _{G max} / l _{G min})	12 / 35 kg	10 / 35 kg
DB drawing No.	3 Ebgw 01.58	3 Ebgw 01.52
DB material No.	157 534	157 533

Telescopic Earthing Stick for T Pin Shafts with Cable Entry

For threaded T pin shafts (bayonet locking mechanism)

The coupling is additionally fitted with a cable entry and a hook for securing the earthing cable and earthing stick at the tower (without adjusting ring).



Type	ESTC SQL H RW 5000
Part No.	769 508
Total length (l _{G max} / l _{G min})	5015 / 2685 mm
Max. load on the operating head (l _{G max} / l _{G min})	10 / 35 kg
DB drawing No.	3 Ebgw 01.55
DB material No.	612 142

4. Carry out Earthing and Short-Circuiting – EaS Devices

Six-part, for T Pin Shafts, with Plastic Coupling

For threaded T pin shafts (bayonet locking mechanism).



Type	EST SQL RW 4915 TA
Part No.	769 506
Total length ($l_{G \max}$ / $l_{G \min}$)	4915 / 1055 mm
Max. load on the operating head ($l_{G \max}$ / $l_{G \min}$)	10 / 35 kg
DB drawing No.	3 Ebgw 01.68
DB material No.	157 489

Kit includes:			
Pos.	Part No.	Pos.	Part No.
1	1x 766 074	4	1x 766 079
2	2x 766 076	5	1x 766 889
3	1x 766 078	6	1x 769 509

For more detailed information on these products, see Accessories chapter.

Six-part, for T Pin Shafts, Aluminium Coupling

For threaded T pin shafts (bayonet locking mechanism).



Type	EST SQL RW 4855 TA
Part No.	769 515 ^{NEW}
Total length ($l_{G \max}$ / $l_{G \min}$)	4855 / 1035 mm
Max. load on the operating head ($l_{G \max}$ / $l_{G \min}$)	10 / 35 kg

Kit includes:			
Pos.	Part No.	Pos.	Part No.
1	1x 769 516	4	1x 769 519
2	2x 769 517	5	1x 769 509
3	1x 769 518		

For more detailed information on these products, see Accessories chapter.

4. Carry out Earthing and Short-Circuiting – EaS Devices

EaS Configurator: Easy online Configuration

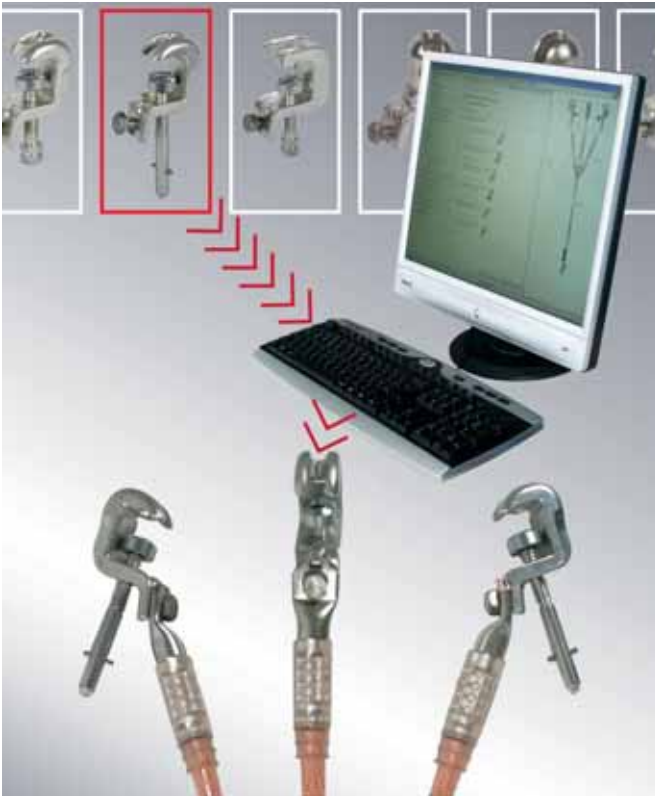

- Easy online selection of the suitable EaS device
- Unique laser marking of the EaS device
- Individual configuration
- Permanent plausibility check in the background
- User-friendly interface
- To start the configuration, simply enter the Variant No., Part No. or Product configuration



General Information:

Standard	EN/IEC 61138 (DIN VDE 0283-3) and EN/IEC 61230 (DIN VDE 0683-100)
Temperature range	-25 °C ... +55 °C
Material (cable)	E-Cu, extra finely stranded and highly flexible
Material (sheath)	Thermoplastic (soft PVC compound YM2)
Hole (terminal lug)	Ø12.5 mm

With the help of the earthing and short-circuiting configurator customised earthing and short-circuiting devices (EaS) for switchgear installations and overhead lines can be configured online at www.dehn.de/de/euk. The configurator provides you with two options to start the configuration (product or system view).

The product view is ideally suited for users who know exactly what they need and already have a concrete idea of, for example, the cable cross-section and clamps to be used.

As an alternative, the system view can be selected. For this extended version of the product view, information on the installation must be provided.

The place of use (switchgear installation or overhead line) of the EaS device is decisive for the selection of the clamps.

A permanent plausibility check ensures reliable selection of the right device. Further accessories such as earthing sticks are optionally displayed for the configured EaS devices.

At the end of the configuration the result is graphically shown and a detailed description of the earthing and short-circuiting device is provided. Moreover a unique Variant No. is assigned to the application-specific earthing and short-circuiting device, which will be lasered on the device later.



You will find the EaS configurator and a demo version at www.dehn.de/de/euk

The EaS configurator is graphically divided into three parts:

- On the left side, a tree structure of the given information is displayed. You can return to the history and change already selected information at any time. The tree structure allows a clearly structured configuration.
- In the centre you can select or change the required information via the keyboard or the mouse. This is done step by step meaning that a detail must be provided before the next detail is visible and selectable.
- On the right side, the current state is graphically displayed to ensure and facilitate optimal selection. Moreover, data may be entered in the relevant field.

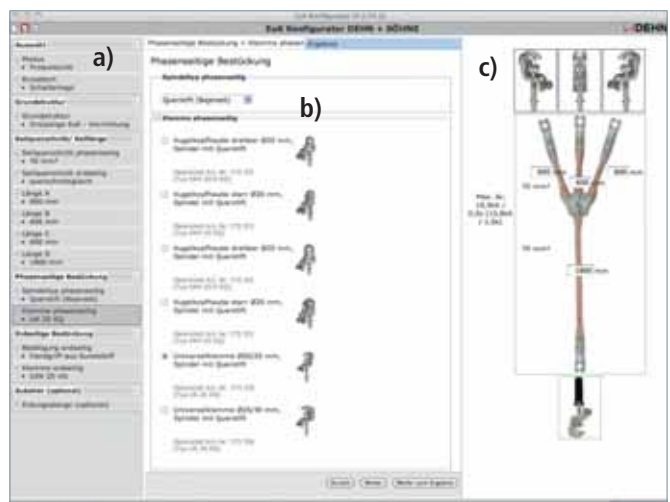

4. Carry out Earthing and Short-Circuiting – EaS Devices

Three-pole, same Cable Cross-Section with Ball Head Caps

... easy configuration ...

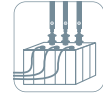

General Information:				
Earth cable end	EAS EK FM 12			
Type	EKV3+1 16 G VGJD2QX	EKV3+1 16 G VGJD2QX	EKV3+1 35 G V3WJMY	EKV3+1 50 G VU8P6LE
Variant No.	VGJD2QX	VRDSN66	V3WJMY	VU8P6LE
Phase cable end	KKH 20 SK	KKH 20 SK	KKH 20 SK	KKH 20 SK
For fixed ball point Ø	20 mm	20 mm	20 mm	20 mm
Cable cross-section Cu	16 mm ²	25 mm ²	35 mm ²	50 mm ²
Max. short-circuit current I _k 0.5 s	4.5 kA	7.0 kA	10.0 kA	14.0 kA
Max. short-circuit current I _k 1 s	3.2 kA	4.9 kA	6.9 kA	9.9 kA
Type	EKV3+1 70 G VCEY1U6	EKV3+1 95 G VA3926U	EKV3+1 120 G VAB3PJV	EKV3+1 150 G V1KPXFR
Variant No.	VCEY1U6	VA3926U	VAB3PJV	V1KPXFR
Phase cable end	KKH 20 SK	KKH 20 SK	KKH 20 SK	KKH 25 SK
For fixed ball point Ø	20 mm	20 mm	20 mm	25 mm
Cable cross-section Cu	70 mm ²	95 mm ²	120 mm ²	150 mm ²
Max. short-circuit current I _k 0.5 s	19.5 kA	26.5 kA	33.5 kA	42.0 kA
Max. short-circuit current I _k 1 s	13.8 kA	18.7 kA	23.7 kA	29.6 kA

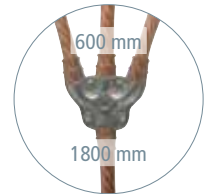
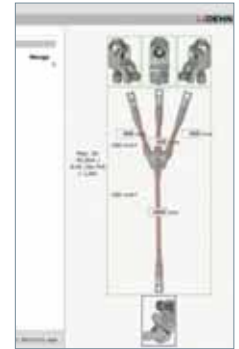

Three-pole, reduced Cable Cross-Section with Ball Head Caps

... easy configuration ...

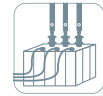

General Information:			
Earth cable end	EAS EK FM 12		
Type	EKV3+1 50 R VD28FAD	EKV3+1 70 R VQYP8B2	EKV3+1 95 R V5SVXPH
Variant No.	VD28FAD	VQYP8B2	V5SVXPH
Phase cable end	KKH 20 SK	KKH 20 SK	KKH 20 SK
For fixed ball point Ø	20 mm	20 mm	20 mm
Cable cross-section Cu	50/25 mm ²	70/35 mm ²	95/35 mm ²
Max. short-circuit current I _k 0.5 s	14.0 kA	19.5 kA	26.5 kA
Max. short-circuit current I _k 1 s	9.9 kA	13.8 kA	18.7 kA
Type	EKV3+1 120 R VTSY9XH		EKV3+1 150 R VHBWUNH
Variant No.	VTSY9XH		VHBWUNH
Phase cable end	KKH 20 SK		KKH 25 SK
For fixed ball point Ø	20 mm		25 mm
Cable cross-section Cu	120/50 mm ²		150/50 mm ²
Max. short-circuit current I _k 0.5 s	33.5 kA		42.0 kA
Max. short-circuit current I _k 1 s	23.7 kA		29.6 kA

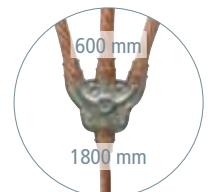
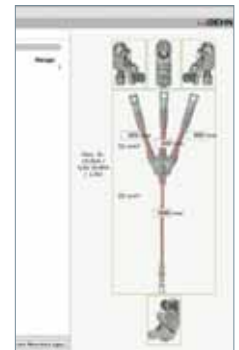

4. Carry out Earthing and Short-Circuiting – EaS Devices



Three-pole, same Cable Cross-Section with Universal Clamp

... easy configuration ...

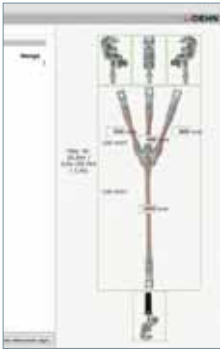

General Information:	
Phase cable end	UK 25 SQ
Earth cable end	UEK 25 HG
For fixed ball point Ø	20 / 25 mm
For T pins with a collar width of	15 mm
Rd / Fl clamping range	20 mm

Type	EKV3+1 16 G V8MCNWM	EKV3+1 25 G V8VF7CP	EKV3+1 35 G V5VN56Z	EKV3+1 50 G VPH98CT
Variant No.	V8MCNWM	V8VF7CP	V5VN56Z	VPH98CT
Cable cross-section Cu	16 mm ²	25 mm ²	35 mm ²	50 mm ²
Max. short-circuit current I _k 0.5 s	4.5 kA	7.0 kA	10.0 kA	14.0 kA
Max. short-circuit current I _k 1 s	3.2 kA	4.9 kA	6.9 kA	9.9 kA

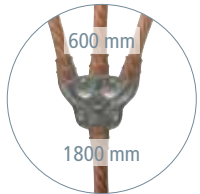

Type	EKV3+1 70 G VMLM2BZ	EKV3+1 95 G VE9HQHJ	EKV3+1 120 G VKZLVU3
Variant No.	VMLM2BZ	VE9HQHJ	VKZLVU3
Cable cross-section Cu	70 mm ²	95 mm ²	120 mm ²
Max. short-circuit current I _k 0.5 s	19.5 kA	26.5 kA	33.5 kA
Max. short-circuit current I _k 1 s	13.8 kA	18.7 kA	23.7 kA



Three-pole, reduced Cable Cross-Section with Universal Clamp

... easy configuration ...

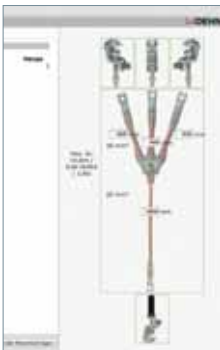

Type	EKV3+1 50 R VMBDCM1	EKV3+1 70 R V4RJ7A2	EKV3+1 95 R VRAB9WB	EKV3+1 120 R VACNLP8
Variant No.	VMBDCM1	V4RJ7A2	VRAB9WB	VACNLP8
Phase cable end	UK 25 SQ	UK 25 SQ	UK 25 SQ	UK 25 SQ
Earth cable end	UEK 25 HG	UEK 25 HG	UEK 25 HG	UEK 25 HG
For fixed ball point Ø	20 / 25 mm	20 / 25 mm	20 / 25 mm	20 / 25 mm
For T pins with a collar width of	15 mm	15 mm	15 mm	15 mm
Rd / Fl clamping range	20 mm	20 mm	20 mm	20 mm
Cable cross-section Cu	50/25 mm ²	70/35 mm ²	95/35 mm ²	120/50 mm ²
Max. short-circuit current I _k 0.5 s	14.0 kA	19.5 kA	26.5 kA	33.5 kA
Max. short-circuit current I _k 1 s	9.9 kA	13.8 kA	18.7 kA	23.7 kA

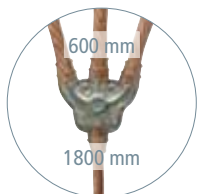

4. Carry out Earthing and Short-Circuiting – EaS Devices

Single-pole with Phase Screw Clamp

... easy configuration ...



Type	EKV1+1 16 VE5E8FZ	EKV1+1 25 VF33XR2	EKV1+1 35 V43FCV8	EKV1+1 50 V2KWXUL
Variant No.	VE5E8FZ	VF33XR2	V43FCV8	V2KWXUL
Phase cable end	PSK 4 30 SQL	PSK 4 30 SQL	PSK 4 30 SQL	PSK 4 30 SQL
Earth cable end	EFK FL40 SKN	EFK FL40 SKN	EFK FL40 SKN	EFK FL40 SKN
Clamping range Ø	4 ... 30 mm	4 ... 30 mm	4 ... 30 mm	4 ... 30 mm
Cable cross-section Cu	16 mm ²	25 mm ²	35 mm ²	50 mm ²
Max. short-circuit current I _k 0.5 s	4.5 kA	7.0 kA	10.0 kA	14.0 kA
Max. short-circuit current I _k 1 s	3.2 kA	4.9 kA	6.9 kA	9.9 kA

Type	EKV1+1 70 VRP32FL	EKV1+1 95 V2WPYVF	EKV1+1 120 VG4GXHQ
Variant No.	VRP32FL	V2WPYVF	VG4GXHQ
Phase cable end	PSK 4 30 SQL	PSK 10 65 SQL	PSK 10 65 SQL
Earth cable end	EFK FL40 SKN	UEK 30 HG	UEK 30 HG
Clamping range Ø	4 ... 30 mm	10 ... 65 mm	10 ... 65 mm
Cable cross-section Cu	70 mm ²	95 mm ²	120 mm ²
Max. short-circuit current I _k 0.5 s	19.5 kA	26.5 kA	33.5 kA
Max. short-circuit current I _k 1 s	13.8 kA	18.7 kA	23.7 kA



Single-pole with Universal Clamp

... easy configuration ...



General Information:	
Phase cable end	UK 25 SQ
Earth cable end	UEK 30 HG
For fixed ball point Ø	20 / 25 mm
For T pins with a collar width of	15 mm
Rd / Fl clamping range	20 mm

Type	EKV1+1 16 VMZDL8N	EKV1+1 25 VB1DETL	EKV1+1 35 V8PPJEF	EKV1+1 50 VQY44GL
Variant No.	VMZDL8N	VB1DETL	V8PPJEF	VQY44GL
Cable cross-section Cu	16 mm ²	25 mm ²	35 mm ²	50 mm ²
Max. short-circuit current I _k 0.5 s	4.5 kA	7.0 kA	10.0 kA	14.0 kA
Max. short-circuit current I _k 1 s	3.2 kA	4.9 kA	6.9 kA	9.9 kA

Type	EKV1+1 70 VFZ17TJ	EKV1+1 95 VWBDMPS	EKV1+1 120 V3CM9FR
Variant No.	VFZ17TJ	VWBDMPS	V3CM9FR
Cable cross-section Cu	70 mm ²	95 mm ²	120 mm ²
Max. short-circuit current I _k 0.5 s	19.5 kA	26.5 kA	33.5 kA
Max. short-circuit current I _k 1 s	13.8 kA	18.7 kA	23.7 kA

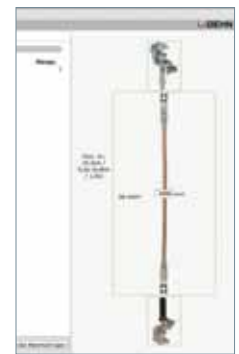

4. Carry out Earthing and Short-Circuiting – EaS Devices

Kits for Railway Applications

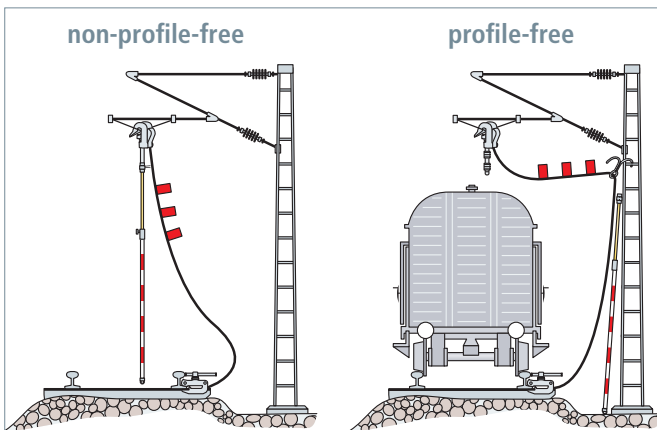

Parts list:			
Pos.	Part No.	Pos.	Part No.
1	784 755	10	751 150
2	773 251	11	740 124
3	784 352	12	769 502
4	792 450	13	769 508
5	792 453	14	769 506
6	774 251	15	769 352
7	751 085	16	761 015
8	751 120	17	785 111
9	751 040	18	700 000

General Information:

Standard	EN/IEC 61230 (DIN VDE 0683-100)
Temperature range	-25 °C ... +55 °C

Kit for Overhead Contact Lines (non-profile-free)

Telescopic earthing stick with adjusting ring (max. 5 m long)

Kit includes:		
Type	Part No.	Pos.-Nr.
Tommy bar (K) or ratchet (R)		
EKV K 50 8500	1x 751 086	1+4+7
EKV R 50 8500	1x 751 087	1+5+7
ESTC SQL RW 5000	1x 769 502	12

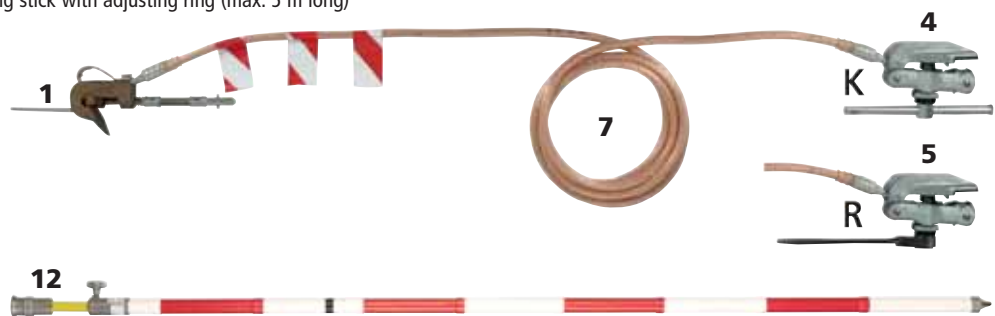

Type BEV ...	OL NPF K	OL NPF R
Part No.	750 210	750 218
Design	Tommy bar	Ratchet
Cable cross-section	50 mm ²	50 mm ²
Cable length	8500 mm	8500 mm
DB drawing No.	3 Ebgw 01.51	—
DB material No.	237 117	—

Kit for Overhead Contact Lines for Transport in Motor Vehicles (non-profile-free)

For technical emergency service and emergency management

Telescopic earthing stick kit consisting of six elements, pluggable (max. 5 m long).

Kit includes:		
Type	Part No.	Pos.-Nr.
Tommy bar (K) or ratchet (R)		
EKV K 50 8500	2x 751 086	1+4+7
EKV R 50 8500	2x 751 087	1+5+7
EST SQL RW 4915 TA	1x 769 506	14
STT 55 27 30	1x 785 111	17



Type BEV ...	OL NPF PKW K	OL NPF PKW R
Part No.	750 196	750 216
Design	Tommy bar	Ratchet
Cable cross-section	50 mm ²	50 mm ²
Cable length	8500 mm	8500 mm
DB drawing No.	3 Ebgw 01.67	—
DB material No.	237 125	—

4. Carry out Earthing and Short-Circuiting – EaS Devices

Kit for Overhead Contact Lines (profile-free *)

Telescopic earthing stick with adjusting ring (max. 5 m long).

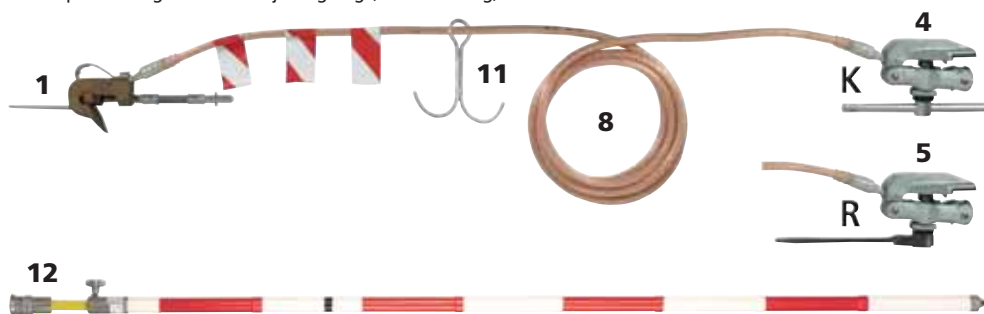

Kit includes:		
Type	Part No.	Pos.-Nr.
Tommy bar (K) or ratchet (R)		
EKV K H 50 12000	1x 751 121	1+4+8+11
EKV R H 50 12000	1x 751 122	1+5+8+11
ESTC SQL RW 5000	1x 769 502	12

Type BEV ...	OL PF K	OL PF R
Part No.	750 211	750 219
Design	Tommy bar	Ratchet
Cable cross-section	50 mm ²	50 mm ²
Length of phase cable A	—	l mm
Cable length	12000 mm	12000 mm
DB drawing No.	3 Ebgw 01.51	—
DB material No.	237 118	—

*) Profile-free earthing means that the earthing cable can be suspended on the tower thus allowing for limited diesel locomotive operation.

Kit for Overhead Contact Lines (profile-free *)

Telescopic earthing stick with cable entry and suspension hook (max. 5 m long).

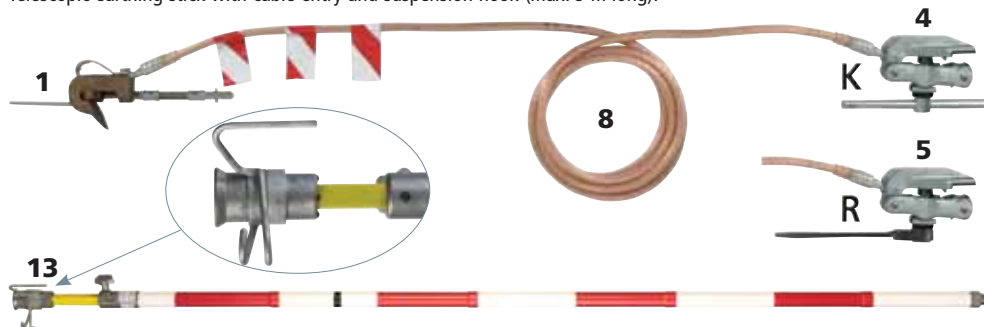

Kit includes:		
Type	Part No.	Pos.-Nr.
Tommy bar (K) or ratchet (R)		
EKV K 50 12000	1x 751 126	1+4+8
EKV R 50 12000	1x 751 127	1+5+8
ESTC SQL H RW 5000	1x 769 508	13

Type BEV ...	OL PF V2 K	OL PF V2 R
Part No.	750 214	750 221
Design	Tommy bar	Ratchet
Cable cross-section	50 mm ²	50 mm ²
Cable length	12000 mm	12000 mm
DB drawing No.	3 Ebgw 01.51	—
DB material No.	237 115	—

*) Profile-free earthing means that the earthing cable can be suspended on the tower thus allowing for limited diesel locomotive operation.

4. Carry out Earthing and Short-Circuiting – EaS Devices

Kit for Overhead Contact Lines for Transport in Motor Vehicles (profile-free *)

For technical emergency service and emergency management

Telescopic earthing stick kit consisting of six elements, pluggable (max. 5 m long).

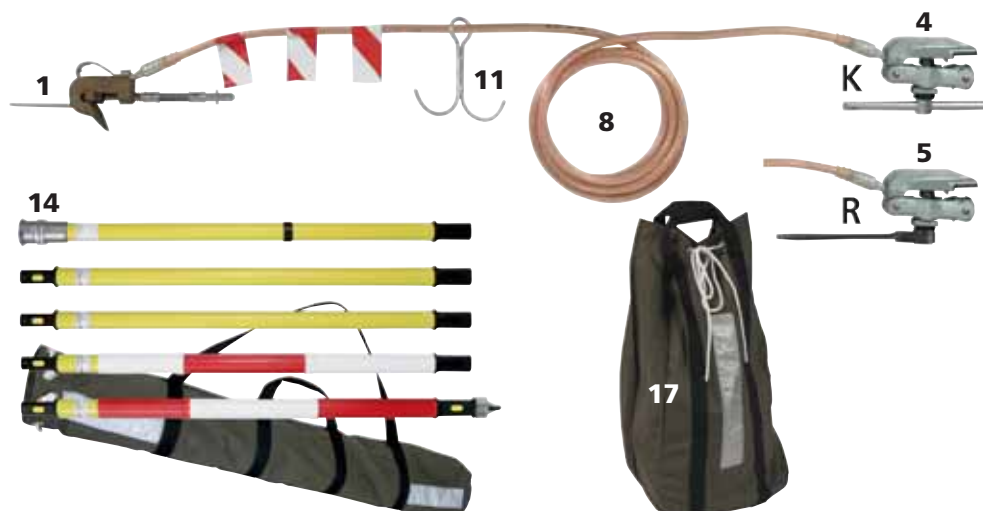

Kit includes:		
Type	Part No.	Pos.-Nr.
Tommy bar (K) or ratchet (R)		
EKV K H 50 12000	2x 751 121	1+4+8+11
EKV R H 50 12000	2x 751 122	1+5+8+11
EST SQL RW 4915 TA	2x 769 506	14
STT 55 27 30	1x 785 111	17

Type BEV ...	OL PF PKW K	OL PF PKW R
Part No.	750 200	750 217
Design	Tommy bar	Ratchet
Cable cross-section	50 mm ²	50 mm ²
Cable length	12000 mm	12000 mm
DB drawing No.	3 Ebgw 01.67	—

*) Profile-free earthing means that the earthing cable can be suspended at the tower, thus allowing for limited diesel locomotive operation.

Kit for Transformers at Overhead Line Towers

For earthing on fuse carriers

Telescopic earthing stick with adjusting ring (max. 3.5 m long).

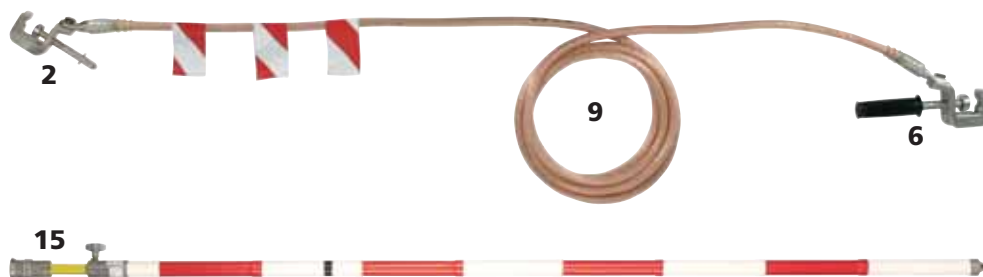

Kit includes:		
Type	Part No.	Pos.-Nr.
EKV UK 50 4000	2x 750 041	2+6+9
ESTC SQL RW 3500	1x 769 352	15

Type BEV ...	US OL ST
Part No.	750 212
Cable cross-section	50 mm ²
Cable length	4000 mm
DB drawing No.	3 Ebgw 01.57
DB material No.	237 121

4. Carry out Earthing and Short-Circuiting – EaS Devices

Kit for Supply Lines, Line Feeders, Bypass Lines and other Types of Lines

For earthing the supply line and traction current lines

Telescopic earthing stick with adjusting ring (max. 3.5 m long).



Kit includes:		
Type	Part No.	Pos.-Nr.
EKV LK 50 4000	1x 750 042	3+6+9
ESTC SQL RW 3500	1x 769 352	15



Type BEV ...	SVUL
Part No.	750 213
Cable cross-section	50 mm ²
Cable length	4000 mm
DB drawing No.	3 Ebgw 01.57
DB material No.	237 119

Kit for Electric Point and Train Pre-Heating Systems

For the initial equipment of a transformer of electric point and train pre-heating systems.

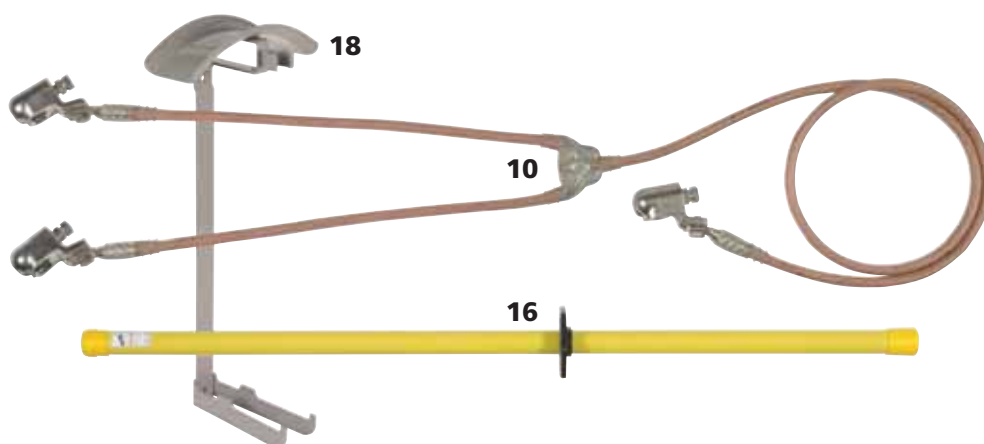

Kit includes:		
Type	Part No.	Pos.-Nr.
EKV2 50 KKH 600 1800	2x 751 150	10
ES SK 1500	1x 761 015	16
HV EKV ES30	1x 700 000	18

Type BEV ...	WHA ZVA
Part No.	750 215
Cable cross-section	50 mm ²
Length of phase cable A	600 mm
Length of phase cable C	600 mm
Length of earthing cable	1800 mm
DB drawing No.	3 Ebgw 01.70
DB material No.	742 402

For voltage detectors for electric point heating systems, please refer to the PHE voltage detector chapter.

4. Carry out Earthing and Short-Circuiting – EaS Devices

Earthing and Short-Circuiting Devices for Railway Applications

Parts list:			
Pos.	Part No.	Pos.	Part No.
1	784 755	7 Cu	751 085
2	773 251	7 Al	752 085
3	784 352	8 Cu	751 120
4	792 450	8 Al	752 120
5	792 453	9	751 040
6	774 251	10	750 202
		11	740 124



General Information:

Standard	EN/IEC 61230 (DIN VDE 0683-100) and IEC 61138
Temperature range	- 25 °C ... + 55 °C

With Earth Clamp for Overhead Contact Lines and Clamp for Railway Tracks with Tommy Bar

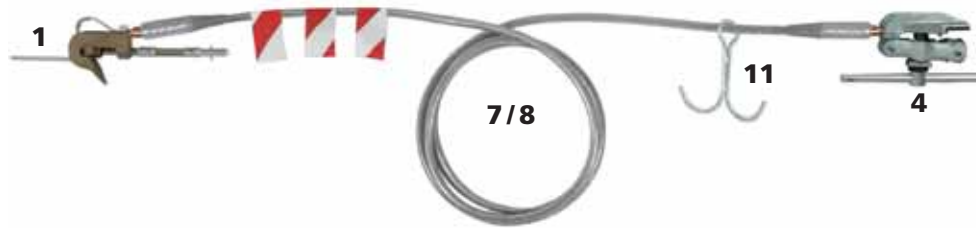

Type	EKV K 50 8500	EKV K 50 12000	EKV K H 50 12000
Part No.	751 086	751 126	751 121
Material (cable)	Cu	Cu	Cu
Cable cross-section	50 mm ²	50 mm ²	50 mm ²
Cable length	8500 mm	12000 mm	12000 mm
Hook	—	—	✓
DB drawing No.	3 Ebgw 01.51/67	3 Ebgw 01.51/67	3 Ebgw 01.51/67

NEW

Type	EKV FD K 70 8500AL	EKV FD K 70 12000AL	EKV FD K H70 12000AL
Part No.	752 086	752 126	752 121
Material (cable)	Al	Al	Al
Cable cross-section	70 mm ²	70 mm ²	70 mm ²
Cable length	8500 mm	12000 mm	12000 mm
Hook	—	—	✓
DB drawing No.	Ebgw 01.74	Ebgw 01.74	Ebgw 01.79

With Earth Clamp for Overhead Contact Lines and Clamp for Railway Tracks with Ratchet



Type	EKV R 50 8500	EKV R 50 12000	EKV R H 50 12000
Part No.	751 087	751 127	751 122
Material (cable)	Cu	Cu	Cu
Cable cross-section	50 mm ²	50 mm ²	50 mm ²
Cable length	8500 mm	12000 mm	12000 mm
Hook	—	—	✓
DB drawing No.	3 Ebgw 01.51/67	3 Ebgw 01.51/67	3 Ebgw 01.51/67

NEW

Type	EKV FD R 70 8500AL	EKV FD R 70 12000AL	EKV FD R H70 12000AL
Part No.	752 087	752 127	752 122
Material (cable)	Al	Al	Al
Cable cross-section	70 mm ²	70 mm ²	70 mm ²
Cable length	8500 mm	12000 mm	12000 mm
Hook	—	—	✓
DB drawing No.	Ebgw 01.78	Ebgw 01.78	Ebgw 01.80

4. Carry out Earthing and Short-Circuiting – EaS Devices

With Universal Clamp (T Pin Shaft) and Universal Clamp (Handle)

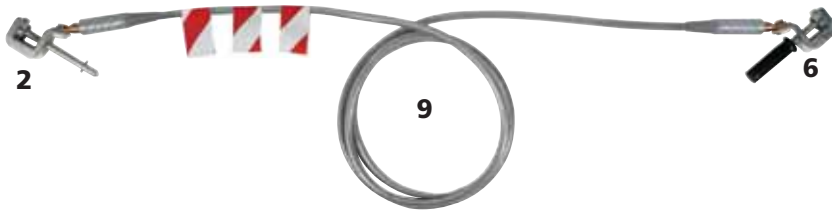

Type	EKV UK 50 4000	EKV UKQ UKH70 4000AL
Part No.	750 041	752 041
Material (cable)	Cu	Al
Cable cross-section	50 mm ²	70 mm ²
Cable length	4000 mm	4000 mm
DB drawing No.	3 Ebgw 01.57	Ebgw 01.73

NEW

With Conductor Clamp and Universal Clamp (Handle)



Type	EKV LK 50 4000	EKV LK UKH 70 4000AL
Part No.	750 042	752 042
Material (cable)	Cu	Al
Cable cross-section	50 mm ²	70 mm ²
Cable length	4000 mm	4000 mm
DB drawing No.	3 Ebgw 01.57	Ebgw 01.77

NEW

With Ball Head Caps (Ø25 mm)

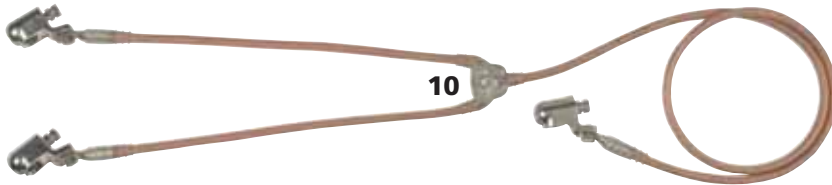

Type	EKV2 50 KKH 600 1800
Part No.	751 150
Material (cable)	Cu
Cable cross-section	50 mm ²
Cable length	600 / 1800 mm
DB drawing No.	3 Ebgw 01.70
DB material No.	742 400

With Universal Clamp (Handle) and Clamp for Railway Tracks with Tommy Bar



Type	BEV MF SE K	BEV BM HZ BDW K	BEV UKH K 70 8500AL	BEV UKH K 70 12000AL
Part No.	751 191	751 193	752 191	752 193
Material (cable)	Cu	Cu	Al	Al
Cable cross-section	50 mm ²	50 mm ²	70 mm ²	70 mm ²
Cable length	8500 mm	12000 mm	8500 mm	12000 mm
DB drawing No.	3 Ebgw 01.56	3 Ebgw 01.56	Ebgw 01.75	Ebgw 01.75

NEW

4. Carry out Earthing and Short-Circuiting – EaS Devices

With Universal Clamp (Handle) and Clamp for Railway Tracks with Ratchet

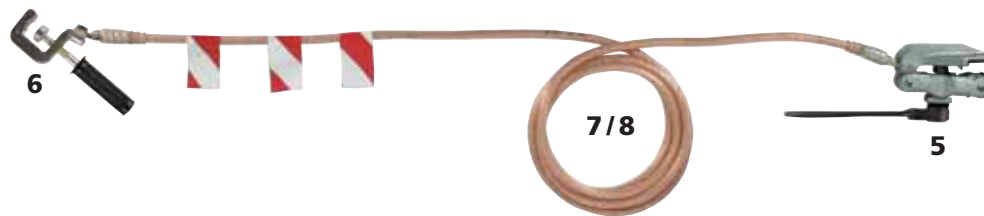

NEW

Type	BEV MF SE R	BEV BM HZ BDW R	BEV UKH R 70 8500AL	BEV UKH R 70 12000AL
Part No.	751 196	751 197	752 196	752 197
Material (cable)	Cu	Cu	Al	Al
Cable cross-section	50 mm ²	50 mm ²	70 mm ²	70 mm ²
Cable length	8500 mm	12000 mm	8500 mm	12000 mm
DB drawing No.	3 Ebgw 01.56	3 Ebgw 01.56	Ebgw 01.76	Ebgw 01.76

With Universal Clamps (Handle) on both Sides

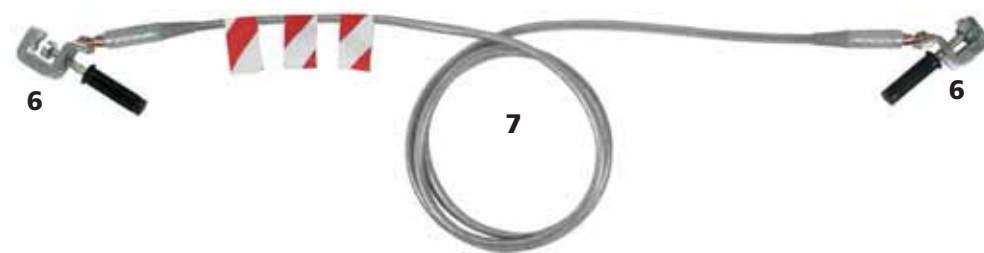

NEW

Type	BEV MF LTE	BEV 2XUKH 70 8500AL
Part No.	751 192	752 192
Material (cable)	Cu	Al
Cable cross-section	50 mm ²	70 mm ²
Cable length	8500 mm	8500 mm
DB drawing No.	3 Ebgw 01.56	Ebgw 01.72

Accessories for Earthing and Short-Circuiting Devices for Railway Applications

Single-pole Earthing and Short-Circuiting Cable, unequipped

With red and white marking and cable lug with borehole Ø10 mm.

General Information:

Crimped cable lug PK2 (Ø10.5 mm)



NEW



Type	EKS 50 BEV 4M	EKS 50 BEV 8.5M	EKS 50 BEV 12M	EKS 50 BEV 13M	EKS 50 BEV 14M
Part No.	751 040	751 085	751 120	751 130	751 140
Material	Cu	Cu	Cu	Cu	Cu
Cable cross-section	50 mm ²	50 mm ²	50 mm ²	50 mm ²	50 mm ²
Cable length	4000 mm	8500 mm	12000 mm	13000 mm	14000 mm
DB material No.	157 511	157 512	157 513	—	—

Type	EKS B10.5 70 4000AL	EKS B10.5 70 8500AL	EKS B10.5 70 12000AL	EKS B10.5 70 13000AL	EKS B10.5 70 14000AL
Part No.	752 040 ^{NEW}	752 085 ^{NEW}	752 120 ^{NEW}	752 130 ^{NEW}	752 140 ^{NEW}
Material	Al	Al	Al	Al	Al
Cable cross-section	70 mm ²	70 mm ²	70 mm ²	70 mm ²	70 mm ²
Cable length	4000 mm	8500 mm	12000 mm	13000 mm	14000 mm
DB material No.	—	—	—	—	—

Suspension Hook

For (profile-free) suspension of earthing cables on towers.



Type	EHH BEV OL
Part No.	740 124
DB material No.	778 794

4. Carry out Earthing and Short-Circuiting – EaS Devices

Short-Circuiting Bar

- With longitudinal slot for reliable contact
- For copper or aluminium busbars up to a thickness of 25 mm
- For use with earthing sticks for hexagon or T pin shafts
- Other bar and earthing cable lengths can be selected online via the earthing and short-circuiting configurator

EaS Configurator:
www.dehn.de/en/euk



General Information:

Standard	EN/IEC 61230 (DIN VDE 0683-100)
Temperature range	-25 °C ... +55 °C
Material (earthing cable)	Highly flexible copper
Cable cross-section	50 mm ²



Short-circuiting bar with earthing cable on a switchgear installation

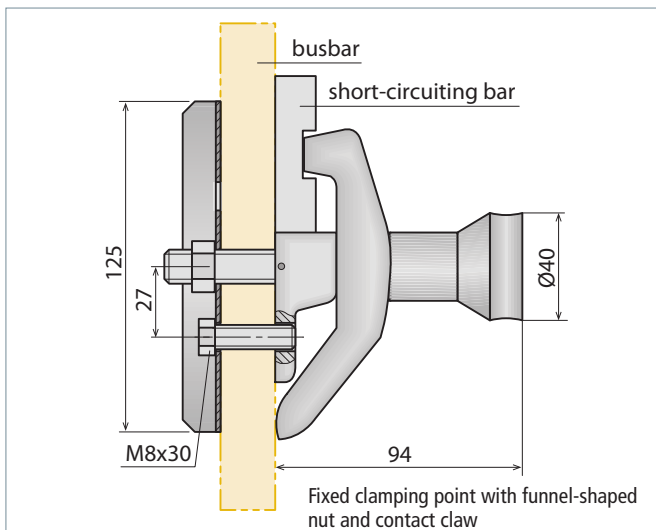

The short-circuiting bar with longitudinal slot can be used for installations without direct neutral point earthing.

For connecting the earthing cable to the earthing system, it is fitted with a rigid ball head cap with a wing bolt for fixed ball points (Ø20 mm) (Part No. 772 312 (type KKH 20 FS)). Other equipment or cable lengths can be selected online via the earthing and short-circuiting configurator.

Short-circuiting bars are available with two different coupling mechanisms for earthing sticks:



SK: Hexagon shaft



SQ: T pin shaft
(bayonet locking mechanism)

Short-Circuiting Bar made of Copper (E-Cu F20)

Rigid ball head cap (KKH 20 FS) on the earth cable end.

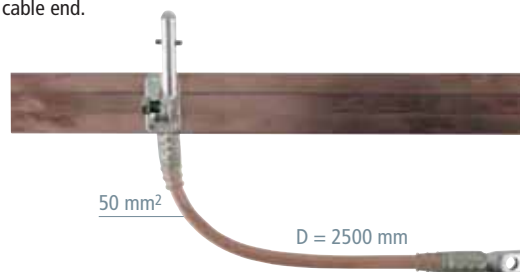

KKH 20 FS

Type KS60 ...	8SK C VYKJW2W	12SK C VCS8GYU	8SQ C V1TDM78	12SQ C VU2EWNF
Variant No.	VYKJW2W	VCS8GYU	V1TDM78	VU2EWNF
Coupling mechanism	SK	SK	SQ	SQ
Position of the coupling mechanism (l _H)	200 mm	200 mm	200 mm	200 mm
Profile	60 x 8 mm	60 x 12 mm	60 x 8 mm	60 x 12 mm
Total length (l _G)	500 mm	500 mm	500 mm	500 mm
Bar spacing (S _A)	150 mm	150 mm	150 mm	150 mm
Max. short-circuit current I _k 0.5 s	100 kA	130 kA	100 kA	130 kA
Max. short-circuit current I _k 1 s	70 kA	90 kA	70 kA	90 kA

Note: When ordering please specify the relevant Variant No.

4. Carry out Earthing and Short-Circuiting – EaS Devices

Short-Circuiting Bar made of Aluminium (AlMgSi 0.5)

Rigid ball head cap (KKH 20 FS) on the earth cable end.

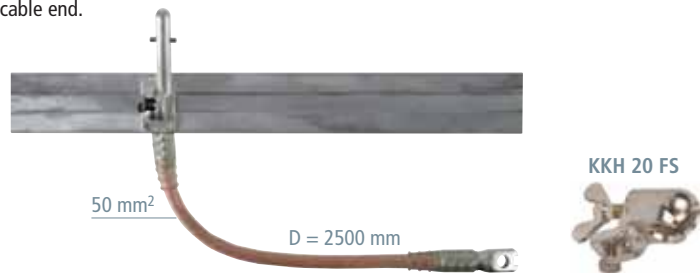

Type KS60 ...	8SK A VUZ656W	12SK A VLUZZB9	8SQ A VUQ18JL	12SQ A VNYHZGF
Variant No.	VUZ656W	VLUZZB9	VUQ18JL	VNYHZGF
Coupling mechanism	SK	SK	SQ	SQ
Position of the coupling mechanism (l_H)	200 mm	200 mm	200 mm	200 mm
Profile	60 x 8 mm	60 x 12 mm	60 x 8 mm	60 x 12 mm
Total length (l_G)	500 mm	500 mm	500 mm	500 mm
Bar spacing (S_A)	150 mm	150 mm	150 mm	150 mm
Max. short-circuit current I_k 0.5 s	60 kA	100 kA	60 kA	100 kA
Max. short-circuit current I_k 1 s	45 kA	70 kA	45 kA	70 kA

Note: When ordering please specify the relevant Variant No.

Two coupling mechanisms are required for a total length > 1000 mm.

Note: When ordering, please specify the Variant No. generated online via the earthing and short-circuiting configurator.

Accessories for Short-Circuiting Bar



Fixed Clamping Point for Busbars

Fixed clamping point with fixing elements for a busbar thickness up to 25 mm and contact claw for short-circuiting bars with longitudinal slot.

Type	KLFP M12 KSS
Part No.	795 040
Type	Threaded shaft with aluminium funnel-shaped nut

SK Screw-Type Adapter

Screw-type adapter to be plugged into earthing sticks for tightening/loosening the funnel-shaped nut of the fixed clamping point. Hexagon shaft (width across flats 19).



Type	SA KLFP SK
Part No.	795 214
Total length (l_G)	60 mm
Width A/F	19 mm

SQ Screw-Type Adapter

Screw-type adapter to be plugged into earthing sticks for tightening/loosening the funnel-shaped nut of the fixed clamping point. T pin shaft (bayonet coupling mechanism).



Type	SA KLFP SQ
Part No.	795 213
Total length (l_G)	100 mm

4. Carry out Earthing and Short-Circuiting – EaS Devices

Earthing and Short-Circuiting Devices (fully insulated) for Low-Voltage Cable Distribution Cabinets

Kit for low-voltage installations, fully insulated Type VI

- Fully insulated, shock-proof version
- Fully equipped kit for cable distribution cabinets
- Safe operation with insulated earthing handle of type VI (with dual function), suitable for both inserting and removing earthing cartridges with T connection as well as for attaching earthing and short-circuiting devices (EaS devices)
- Waterproof, plastic-sheathed cable entries and node unit, with additional anti-kink protection
- Other cable lengths can be selected online via the earthing and short-circuiting configurator



General Information:

Standard	EN/IEC 61230 (DIN VDE 0683-100)
Temperature range	-25 °C ... +55 °C

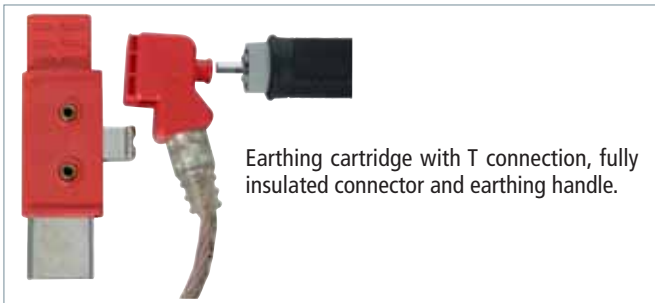

Attaching a fully insulated earthing and short-circuiting device using an earthing handle of type VI

Kit in Plastic Case

Type EKS VI 2F KVS ...	KK
Part No.	745 903
Variant No. of EaS device	V162LDM
Dimensions	450 x 350 x 110 mm

Attention: Please state the relevant Variant No. when ordering.



Kit includes:			
Pos.	Part No.	Pos.	Part No.
1	1x 745 902	5	6x 745 910
3	2x V162LDM	6	1x 745 922
4	3x 745 905		

For more detailed information on these products, see Accessories chapter.

Kit in Sheet Steel Case

Type EKS VI 2F KVS ...	SBK
Part No.	745 901
Variant No. of EaS device	V162LDM
Dimensions	440 x 330 x 100 mm

Attention: Please state the relevant Variant No. when ordering.



Kit includes:			
Pos.	Part No.	Pos.	Part No.
2	1x 745 900	5	6x 745 910
3	2x V162LDM	6	1x 745 922
4	3x 745 905		

For more detailed information on these products, see Accessories chapter.

4. Carry out Earthing and Short-Circuiting – EaS Devices

Single Parts and Accessories for EaS Devices (fully insulated) for Low-Voltage Cable Distribution Cabinets



1

Plastic Case, empty

With foam padding.

Type	KKL EKS VI KVS
Part No.	745 902
Dimensions	450 x 350 x 110 mm



2

Sheet Steel Case, empty

With foam padding.

Type	SBKL EKS VI KVS
Part No.	745 900
Dimensions	440 x 330 x 100 mm

**Plastic Case, empty**

With foam padding and hook-and-loop fastener.

Type	KK 56 41 17 EK VI TI
Part No.	745 952
Dimensions	565 x 410 x 170 mm

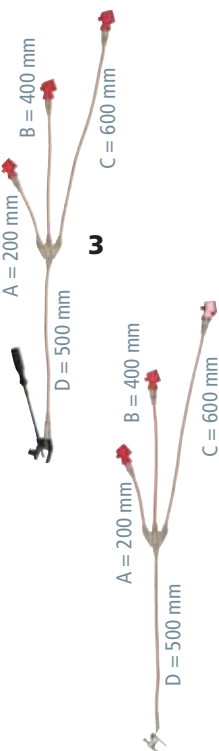

3

Earthing and Short-Circuiting Device VI, Earth Clamp with flexible adjustable HandleAdjustable handle with two positions, clamping range up to 20 mm.
For cable distribution cabinets.

Type	EKV3 25VI DG V162LDM	EKV3 35VI DG VE5K3HM
Variant No.	V162LDM	VE5K3HM
Cable cross-section Cu	25/25 mm ²	35/35 mm ²
Max. short-circuit current I _k 0.5 s	7.0 kA	10.0 kA
Max. short-circuit current I _k 1 s	4.9 kA	6.9 kA

Earthing and Short-Circuiting Device VI, spring-loaded Earth ClampClamping range up to 24 mm, installation via adjustable handle DGF EKV VI.
For cable distribution cabinets.

Type	EKV3 25VI EK VMRSJWD	EKV3 35VI EK VEH4JQY
Variant No.	VMRSJWD	VEH4JQY
Cable cross-section Cu	25/25 mm ²	35/35 mm ²
Max. short-circuit current I _k 0.5 s	7.0 kA	10.0 kA
Max. short-circuit current I _k 1 s	4.9 kA	6.9 kA

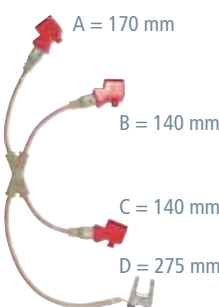
Earthing and Short-Circuiting Device VI, spring-loaded Earth ClampClamping range up to 24 mm, attachment via adjustable handle DGF EKV VI.
For service entrance boxes.A = 170 mm
B = 140 mm
C = 140 mm
D = 275 mm

Type	EKV3 16VI EK VZPW9LG
Variant No.	VZPW9LG
Cable cross-section Cu	16/16 mm ²
Max. short-circuit current I _k 0.5 s	4.5 kA
Max. short-circuit current I _k 1 s	3.2 kA

4. Carry out Earthing and Short-Circuiting – EaS Devices

Single Parts and Accessories for EaS Devices (fully insulated) for Low-Voltage Cable Distribution Cabinets

Spring-loaded Compact Clamp

With T connection and hexagon locking screw (A/F 10) for use with earthing handle VI and fixing via adjustable handle with flexible shaft.

Type	KK TA 0 24 SK10
Part No.	745 503
Clamping range	Up to 24 mm
Max. short-circuit current I_k 0.5 s	10.0 kA
Max. short-circuit current I_k 1 s	6.9 kA



NH 00 Earthing Cartridges

With T connection for installation into NH fuse holders and blocks of size NH 00 using a VI earthing handle.

Type	EP NH00 VI TA
Part No.	745 905
Size	00
Max. cable cross-section Cu	35 mm ²
Max. short-circuit current I_k 0.5 s	10.0 kA
Max. short-circuit current I_k 1 s	6.9 kA



4

NH 1 ... 3 Earthing Cartridges

With T connection for installation into NH fuse holders and blocks of size NH 1 ... 3 using a VI earthing handle.

Type	EP NH1 3 VI TA
Part No.	745 910
Size	1 ... 3
Max. cable cross-section Cu	35 mm ²
Max. short-circuit current I_k 0.5 s	10.0 kA
Max. short-circuit current I_k 1 s	6.9 kA



5

NH 4a Earthing Cartridges

Type	EP NH4A VI TA
Part No.	745 915
Size	4a
Max. cable cross-section Cu	35 mm ²
Max. short-circuit current I_k 0.5 s	10.0 kA
Max. short-circuit current I_k 1 s	6.9 kA



VI Earthing Handle

With dual function

- For installing earthing cartridges with T connection into NH fuse holders
- For connecting VI earthing and short-circuiting devices to earthing cartridges

Type	EG 00 4A VI
Part No.	745 922
Length	285 mm



6

Adjustable Handle with flexible Shaft

With magnetic socket wrench insert.

For connecting spring-loaded earth clamps.

Type	DGF EKV VI
Part No.	745 921
Length	290 mm

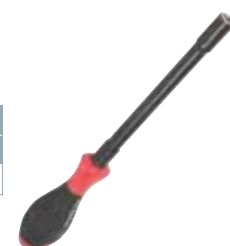

4. Carry out Earthing and Short-Circuiting – EaS Devices

Earthing and Short-Circuiting Devices (partly insulated) for Low-Voltage Cable Distribution Cabinets



Attaching a partly insulated earthing and short-circuiting device using an earthing handle of type TI

Kit for low-voltage installations, partly insulated Type TI

- Fully equipped kit for cable distribution cabinets
- Safe operation with insulated earthing handle of type TI (with dual function), suitable both for installing and removing earthing cartridges with M10 connection as well as for attaching earthing and short-circuiting devices (EaS devices)
- Waterproof, plastic-sheathed cable entries and node unit, with additional anti-kink protection
- Other cable lengths can be selected online via the earthing and short-circuiting configurator



General Information:

Standard	EN/IEC 61230 (DIN VDE 0683-100)
Temperature range	-25 °C ... +55 °C



Earthing cartridge with M10 connection, partly insulated connector and earthing handle.

Kit I in Sheet Steel Case

Kit includes:			
Pos.	Part No.	Pos.	Part No.
1	1x 766 300	6	3x 745 018
3	1x VSUN6NV	9	1x 745 400

For more detailed information on these products, see Accessories chapter.

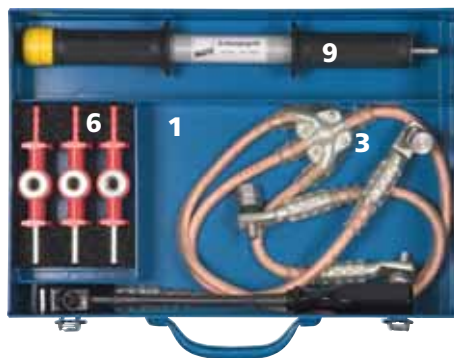

Type EKS TI ...	KVS SBK
Part No.	766 302
Variant No. of EaS device	VSUN6NV
Dimensions	380 x 260 x 80 mm

Attention: Please state the relevant Variant No. when ordering.

Kit II in Sheet Steel Case

Kit includes:			
Pos.	Part No.	Pos.	Part No.
2	1x 766 298	7	3x 745 202
4	2x VUKMT58	8	2x 745 602
5	3x 745 302	9	1x 745 400
6	6x 745 018		

For more detailed information on these products, see Accessories chapter.

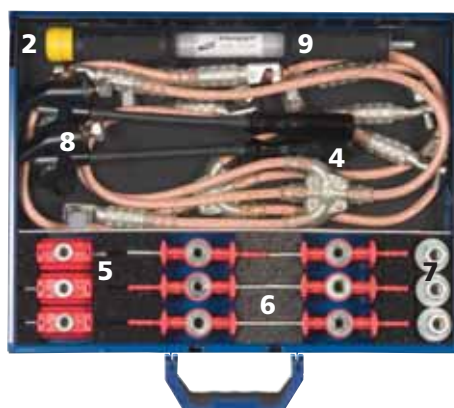

Type EKS TI ...	2F KVS SBK
Part No.	745 500
Variant No. of EaS device	VUKMT58
Dimensions	440 x 330 x 66 mm

Attention: Please state the relevant Variant No. when ordering.

4. Carry out Earthing and Short-Circuiting – EaS Devices

Single Parts and Accessories for EaS Devices (partly insulated) for Low-Voltage Cable Distribution Cabinets

Sheet Steel Case, empty

Type	SBKL EKS TI KVS
Part No.	766 300
Dimensions	380 x 260 x 80 mm



Sheet Steel Case, empty

With foam padding.

Type	SBKL EKS TI KVS 2F
Part No.	766 298
Dimensions	440 x 330 x 66 mm



Plastic Case, empty

With foam padding and hook-and-loop fastener.

Type	KK 56 41 17 EK VI TI
Part No.	745 952
Dimensions	565 x 410 x 170 mm



Earthing and Short-Circuiting Device TI, Earth Clamp with flexible adjustable Handle

Adjustable handle with two positions, clamping range up to 20 mm.
For cable distribution cabinets.

Type	EKV3 25TI DG VSUN6NV	EKV3 35TI DG VSHDQZB
Variant No.	VSUN6NV	VSHDQZB
Cable cross-section Cu	25/25 mm ²	35/35 mm ²
Max. short-circuit current I _k 0.5 s	7.0 kA	10.0 kA
Max. short-circuit current I _k 1 s	4.9 kA	6.9 kA

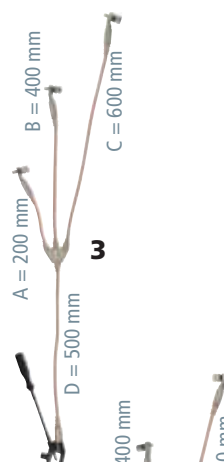

Earthing and Short-Circuiting Device TI, with hook-shaped Cable Lug on the Earth Cable End

For installation of earth clamps EK I FL20 DGF or EK FL20 FS.
For cable distribution cabinets.

Type	EKV3 16TI HK V3RQASE	EKV3 25TI HK VUKMT58	EKV3 35TI HK VDZ2VDX
Variant No.	V3RQASE	VUKMT58	VDZ2VDX
Cable cross-section Cu	16/16 mm ²	25/25 mm ²	35/35 mm ²
Max. short-circuit current I _k 0.5 s	4.5 kA	7.0 kA	10.0 kA
Max. short-circuit current I _k 1 s	3.2 kA	4.9 kA	6.9 kA

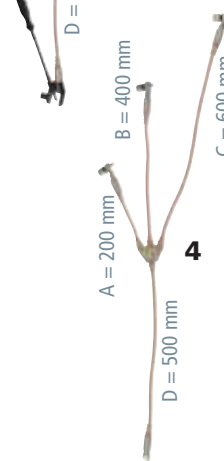

Earthing and Short-Circuiting Device TI, spring-loaded Earth Clamp

Clamping range up to 24 mm and fixing via adjustable handle DGF EKV VI.
Earthing cartridges of size 00 fixed on the phase cable end.
For service entrance boxes.

Type	EKV3 NH00 TI V1RC3P2
Variant No.	V1RC3P2
Cable cross-section Cu	16/16 mm ²
Max. short-circuit current I _k 0.5 s	4.5 kA
Max. short-circuit current I _k 1 s	3.2 kA

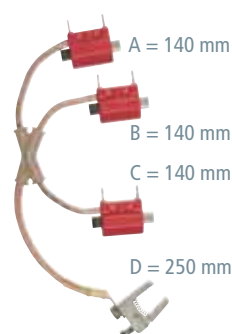

4. Carry out Earthing and Short-Circuiting – EaS Devices

Single Parts and Accessories for EaS Devices (partly insulated) for Low-Voltage Cable Distribution Cabinets

A = 190 mm

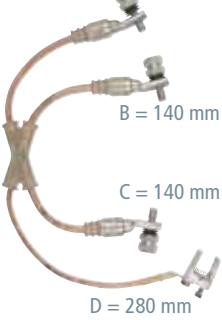

B = 140 mm

C = 140 mm

D = 280 mm

Earthing and Short-Circuiting Device TI, spring-loaded Earth Clamp

Clamping range up to 24 mm and fixing via adjustable handle DGF EKV VI.
Screw-on cable lugs with M10 hexagon pin on the phase cable end.
To be screwed onto earthing cartridges with M10 connection of service entrance boxes.

Type	EKV3 16TI EK VSB29AH
Variant No.	VSB29AH
Cable cross-section Cu	16/16 mm ²
Max. short-circuit current I _k 0.5 s	4.5 kA
Max. short-circuit current I _k 1 s	3.2 kA



5

NH 00 Earthing Cartridges

With M10 connection for insertion into NH fuse holders and blocks of size NH 00 using a TI earthing handle.

Type	EP NH00 TI M10
Part No.	745 302
Size	00
Max. cable cross-section Cu	35 mm ²
Max. short-circuit current I _k 0.5 s	10.0 kA
Max. short-circuit current I _k 1 s	6.9 kA



6

NH 1 ... 3 Earthing Cartridges

With M10 connection for insertion into NH fuse holders and blocks of size NH 1 ... 3 using a TI earthing handle.

Type	EP NH1 3 TI M10
Part No.	745 018
Size	1 ... 3
Max. cable cross-section Cu	35 mm ²
Max. short-circuit current I _k 0.5 s	10.0 kA
Max. short-circuit current I _k 1 s	6.9 kA

**NH 4a Earthing Cartridges**

With M10 connection for insertion into NH fuse holders and blocks of size NH 4a.

Type	EP NH4A TI M10
Part No.	745 016
Size	4a
Max. cable cross-section Cu	35 mm ²
Max. short-circuit current I _k 0.5 s	10.0 kA
Max. short-circuit current I _k 1 s	6.9 kA

**NH 1 ... 3 Earthing Cartridges with grip Lugs**

With M10 connection for use with TI earthing handle or NH fuse handle with sleeve NHS AG 00 3 NS.

Type	EP NH1 3 TI GL M10
Part No.	745 017
Size	1 ... 3
Max. cable cross-section Cu	35 mm ²
Max. short-circuit current I _k 0.5 s	10.0 kA
Max. short-circuit current I _k 1 s	6.9 kA

Screw-in Earthing Insert with M10 connection, insulated

Insulated thread.
To be screwed into E27 and E33 threaded fuse holders using a TI earthing handle.



7

Type	ESE E27 TI M10	ESE E33 TI M10
Part No.	745 201	745 202
Size	E27	E33
Contact pin	Brass/gal CuSn	Brass/gal CuSn
Thread	Plastic	Plastic
Max. cable cross-section Cu	25 mm ²	25 mm ²
Max. short-circuit current I _k 0.5 s	7.0 kA	7.0 kA
Max. short-circuit current I _k 1 s	4.9 kA	4.9 kA

4. Carry out Earthing and Short-Circuiting – EaS Devices

Single Parts and Accessories for EaS Devices (partly insulated) for Low-Voltage Cable Distribution Cabinets

Screw-in Earthing Insert with M10 connection

Conductive thread.

To be screwed into E27 and E33 threaded fuse holders using a TI earthing handle.

Type	ESE E27 KBI M10	ESE E33 KBI M10
Part No.	745 203	745 204
Size	E27	E33
Contact pin	Plastic	Plastic
Thread	Brass/gal CuSn	Brass/gal CuSn
Max. cable cross-section Cu	25 mm ²	25 mm ²
Max. short-circuit current I _k 0.5 s	7.0 kA	7.0 kA
Max. short-circuit current I _k 1 s	4.9 kA	4.9 kA



Earth Clamp with flexible adjustable Handle and two setting Positions

To be connected to the earth cable end of earthing and short-circuiting devices for cable distribution cabinets, with M8 pin, anti-rotation element and nut.

Type	EK I FL20 DGF
Part No.	745 602
Clamping range	Up to 20 mm

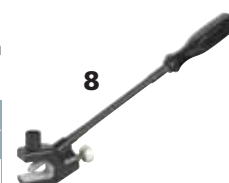

Bare Earth Clamp with Wing Bolt

To be connected to the earth cable end of earthing and short-circuiting devices for cable distribution cabinets, with M8 pin, anti-rotation element and nut.

Type	EK FL20 FS
Part No.	745 502
Clamping range	Up to 20 mm



Spring-loaded Compact Clamp

With threaded bolt M8 x 12 mm and hexagon locking screw (wrench size 10).

Fixed by means of adjustable handle with flexible shaft.

Type	KK M8 0 24 SK 10
Part No.	745 508
Clamping range	Up to 24 mm
Max. short-circuit current I _k 0.5 s	10.0 kA
Max. short-circuit current I _k 1 s	6.9 kA



TI Earthing Handle

With dual function.

- For installing earthing cartridges or screw-in earthing inserts with M10 connection
- For connecting TI earthing and short-circuiting devices to earthing cartridges (wrench size 19)

Type	EG TI EKV
Part No.	745 400
Length	355 mm



Adjustable Handle with flexible Shaft

With magnetic socket wrench insert.

For connecting spring-loaded earth clamps.

Type	DGF EKV VI
Part No.	745 921
Length	290 mm



4. Carry out Earthing and Short-Circuiting – EaS Devices

Earthing and Short-Circuiting Devices for Crane Conductor Bars



Three-pole earthing and short-circuiting device with screw clamps.

With screw clamps

- For insulated or bare conductor bars of cranes and lifting equipment
- Allows to lock the clamping range of the clamps in several positions
- Waterproof, plastic-sheathed cable entries and node unit, with additional ant-kink protection
- Other cable lengths can be selected online via the earthing and short-circuiting configurator



General Information:

Standard	EN/IEC 61230 (DIN VDE 0683-100)
Temperature range	-25 °C ... +55 °C
Material (clamp body)	MCl/gal Zn
Material (pressure plates)	Cu alloy
Material (short-circuiting cables)	Highly flexible copper

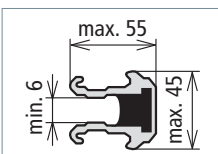

Insulated conductor bar

With Screw Clamps for insulated Conductor Bars

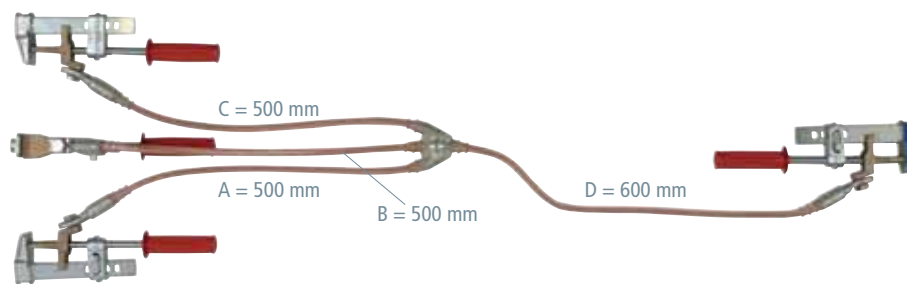

Type EKV3 ...	25IS ZK VH8QTCZ	35IS ZK VKB2Q6J	50IS ZK VP6YV4T
Variant No.	VH8QTCZ	VKB2Q6J	VP6YV4T
Clamping range	55 mm	55 mm	55 mm
Cable cross-section Cu	25/25 mm ²	35/35 mm ²	50/50 mm ²
Max. short-circuit current I _k 0.5 s	7.0 kA	10.0 kA	14.0 kA
Max. short-circuit current I _k 1 s	4.9 kA	6.9 kA	9.9 kA

Attention: Please state the relevant Variant No. when ordering.

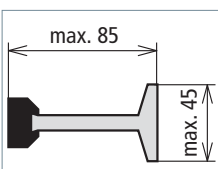

Bare conductor bar

With Screw Clamps for bare Conductor Bars

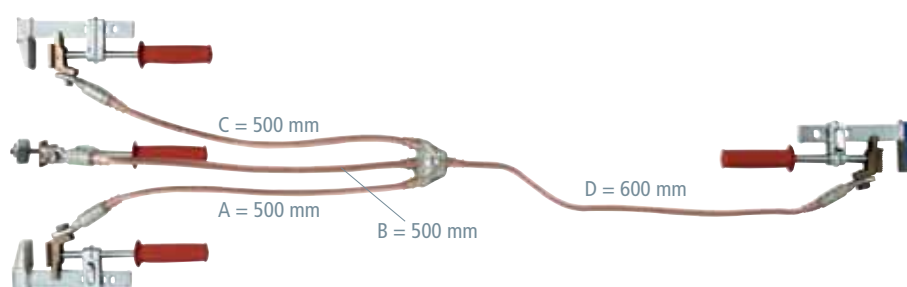

Type EKV3 ...	25BS ZK VQTK4T	35BS ZK VN63A91
Variant No.	VQTK4T	VN63A91
Clamping range	85 mm	85 mm
Cable cross-section Cu	25/25 mm ²	35/35 mm ²
Max. short-circuit current I _k 0.5 s	7.0 kA	10.0 kA
Max. short-circuit current I _k 1 s	4.9 kA	6.9 kA

Attention: Please state the relevant Variant No. when ordering.

The clamp for the PEN conductor is marked in blue.

Detailed product information: www.dehn-international.com/search

4. Carry out Earthing and Short-Circuiting – EaS Devices

Accessories for Earthing and Short-Circuiting Devices for Crane Conductor Bars

Screw Clamps for insulated conductor bars

With M12 bolt.

Type	ZK55 IS	ZK55 IS BL
Part No.	771 230	771 231
Clamping range	55 mm	55 mm



Screw Clamps for bare conductor bars

With M12 bolt.

Type	ZK85 BS	ZK85 BS BL
Part No.	771 232	771 233
Clamping range	85 mm	85 mm



4. Carry out Earthing and Short-Circuiting – EaS Devices

Earthing and Short-Circuiting Device for Street Lighting Systems



Earthing and short-circuiting device installed at a junction and fuse box of a street lighting mast

- For junction and fuse boxes of street lighting systems
- For E14 fuse links
- E27 to E14 thread aluminium adapter
- Max. backup fuse 32 A power circuit breaker (B characteristic)

Kit includes:

Pos.	Part No.	Pos.	Part No.
1	1x 745 106	4	1x 745 109
2	2x 745 107	5	1x 745 921
3	6x 745 108		

For more detailed information on these products, see Accessories chapter.

Kit in Plastic Case



Type	EKV ÜGK MB S
Part No.	745 105
Dimensions	395 x 295 x 105 mm

Accessories for Earthing and Short-Circuiting Device for Street Lighting Systems



1

Plastic Case, empty

With foam padding.

Type	KKL EKV ÜGK MB
Part No.	745 106
Dimensions	395 x 280 x 110 mm
Colour	Grey ●



2

Earthing and Short-Circuiting Device for Street Lighting Systems

With three fixed E14 screw-in earthing inserts and spring-loaded earth clamp, clamping range up to 24 mm (fixed via adjustable handle DGF EKV VI).

Type	EKV ÜGK MB
Part No.	745 107
Cable cross-section	6 mm ²

A, B, C = 270 mm

4. Carry out Earthing and Short-Circuiting – EaS Devices

E27 / E14 Adapter

Reducing insert for converting from E27 to E14 threads.

Allows to use earthing and short-circuiting devices with E14 screw-in earthing inserts even for E27 threads.

Type	RED E27 E14 ÜGK MB
Part No.	745 108
Dimensions	Ø30 x 25 mm
Material	Al



Installation Adapter

For installing E27 / E14 adapters and gauge rings for D-fuses DII and DIII.

Type	PSS DII
Part No.	745 109
Dimensions	Ø30 x 110 mm
Material	Plastic



Adjustable Handle with flexible Shaft

With magnetic socket wrench insert.

For connecting spring-loaded earth clamps.

Type	DGF EKV VI
Part No.	745 921
Length	290 mm



4. Carry out Earthing and Short-Circuiting – EaS Devices

Earthing Handle for Low-Voltage Installations



Attaching an earthing and short-circuiting device in a low-voltage switchgear installation using an earthing handle.

For low-voltage installations

- For attaching earthing and short-circuiting devices in low-voltage installations
- End fitting with plug-in coupling for extending the handle
- Light-weight construction
- Hexagon shaft (width across flats 19) or T pin shaft

General Information:

Standard	T pin shaft DIN 48087
Temperature range	-25 °C ... +55 °C
Material (insulating tube)	Glass-fibre reinforced polyester tube
Material (coupling)	Plastic
Material (end fitting)	Plug-in coupling for extending the handle

Earthing Handle for Hexagon Shafts, Plug-in Coupling

Handle termination with plastic plug-in coupling for extending the handle (spring locking mechanism)

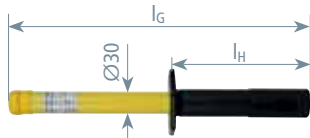

Type EG ...	SK STK 400
Part No.	745 415
Total length (l _G)	400 mm
Length (handle) (l _H)	185 mm

Earthing Handle for T Pin Shafts, Plug-in Coupling

Handle termination with plastic plug-in coupling for extending the handle (bayonet locking mechanism)

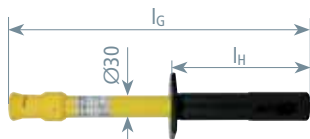

Type EG ...	SQ STK 400
Part No.	745 414
Total length (l _G)	400 mm
Length (handle) (l _H)	185 mm

Insulating Protective Shutters

Rated voltages from 1 kV to 36 kV

- Protection against accidental contact with live parts of installations with rated voltages from 1 kV to 36 kV
- Four different designs for use in almost all types of switchgear installations



General Information:	
Standard	DIN VDE 0682-552
For	Use in indoor installations only



Inserting an insulating protective shutter (type A3) by means of an operating stick

According to the five safety rules, adjacent parts are parts situated in the vicinity zone. If parts of an installation near the work location cannot be disconnected, additional safety measures must be taken before starting work as is the case with work in the vicinity of live parts.

Insulating protective shutters according to DIN VDE 0682-522 are used to provide protection against accidental contact with live parts of an installation. They are portable and inserted under live conditions by hand or by using an operating stick.

Insulating protective shutters are designed for short-term use in indoor electrical installations according to DIN VDE 0101 with voltages from 1 to 36 kV a.c. at nominal frequencies below 100 Hz to provide protection against direct contact according to DIN VDE 0105-100 when working in the vicinity of live parts.

When used in medium-voltage installations, insulating protective shutters might have to be adapted, for example if it is not possible to insert shutters in the live working zone without risk due to unfavourably located drives, switch components or isolating plates. In such cases, a standard-compliant solution can be found by cutting out parts of the insulating protective shutter or cutting it to size. For that purpose, technical details must be provided. We have developed a special template for insulating protective shutters which can be used, for example, to mark the exact location of cut-outs.

For enquiries and orders, visit our website www.dehn-international.com.

Note

Insulating protective shutters do not protect against re-connection. The protected area is the area which is separated from the area containing live parts by the insulating protective shutter. The minimum distances shown in the above table between shutters / shutter edges and live parts must be observed.

The protective part (with length l_s and, if required, height h_s) of insulating protective shutters is the part that provides protection against accidental contact with live parts. It is fitted with either a handle or a coupling for attaching an operating stick.

Outside the live working zone, the following gaps are permissible between shutter edge and cell wall:

- Up to 10 mm without restriction
- Up to 40 mm, if the distance between the shutter edge and the live working zone is at least 100 mm
- Up to 100 mm near a switch subconstruction

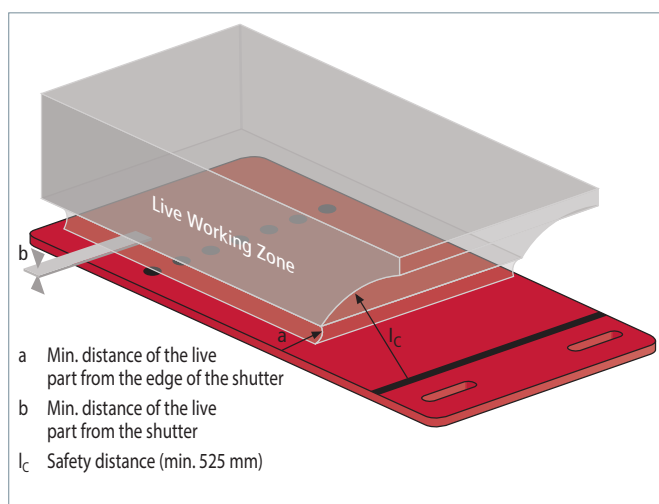

Example of a live working zone in case of an insulating protective shutter of type A1

Rated voltage U_r	Minimum distance of the live part	
	from shutter edge a	from shutter b
3.6 kV	60 mm	0 mm
7.2 kV	90 mm	0 mm
12.0 kV	120 mm	20 mm
24.0 kV	220 mm	60 mm
36.0 kV	320 mm	100 mm

Service und Safety

More details on page 144-145.

5. Provide Protection against adjacent Live Parts – Insulating Protective Shutters

Due to the various designs of switchgear installations, DIN VDE 0682-552 defines four different basic types of protective shutters:

A1, safety distance provides protection during inserting and removing insulating protective shutters.

A2, protective section provides protection during inserting and removing insulating protective shutters

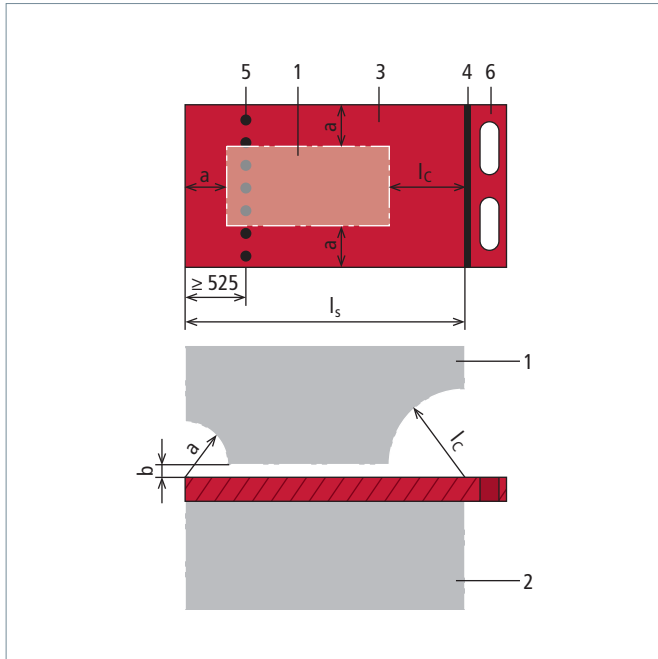

Protective shutter of type A1 – Operation by hand

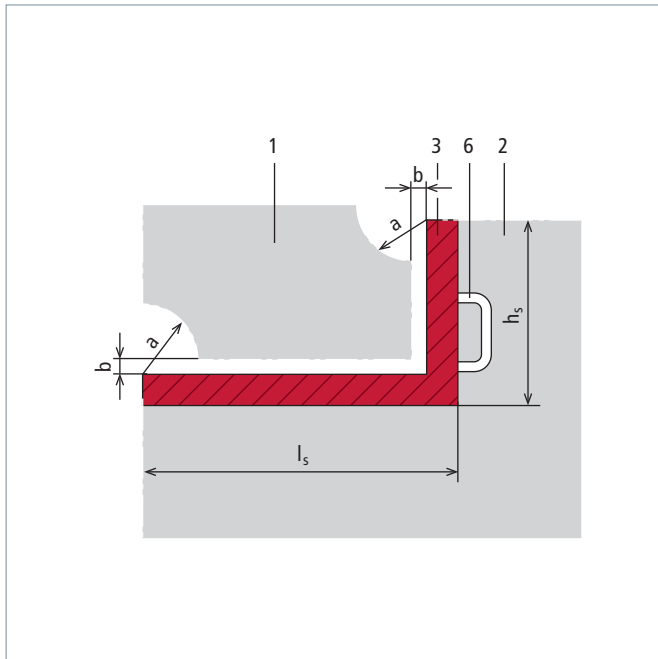

Protective shutter of type A2 – Operation by hand

- 1 Live working zone
- 2 Protected area
- 3 Protective section with length l_s (and height h_s)
- 4 Limit mark or red ring
- 5 Guide mark / hand guard
- 6 Handle
- 7 Coupling
- 8 Insulating element of the operating stick with length l_i

A3, operating stick provides protection during inserting and removing insulating protective shutters

A4, protective device installed in the installation provides protection during inserting and removing insulating protective shutters

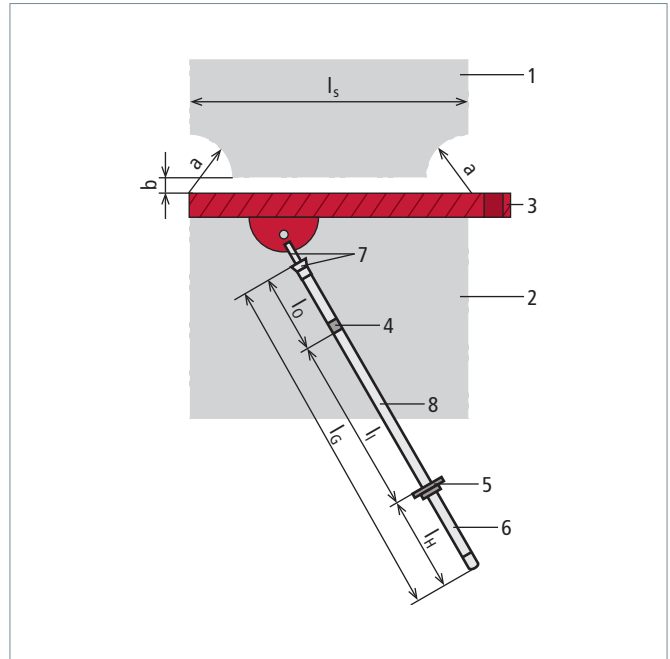

Protective shutter of type A3 – Operation by means of an operating stick

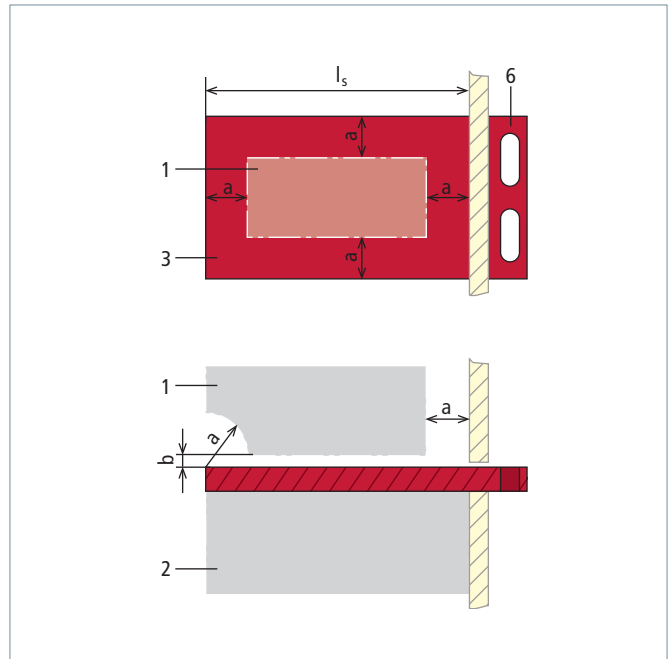

Protective shutter of type A4 – Operation by hand

- l_G Total length of the operating stick
- l_0 Length of the top section of the operating stick
- l_H Length of the handle of the operating stick
- l_i Length of the insulating element of the operating stick
- l_s Length of the protective section
- l_c Safety distance

- a Minimum distance of live parts from the edge of the insulating protective shutter
- b Minimum distance of live parts from the insulating protective shutter

Type A1

With finger holes, guide and limit mark for inserting and removing insulating protective shutters into / from guide rails by hand.

The guide mark is a dotted line with a minimum distance of 525 mm from the rear shutter edge. The section beyond this mark must not be contacted when inserting the insulating protective shutter. The limit mark is a continuous line and separates the handle from the protective section. The section beyond this mark must not be contacted when inserting the insulating protective shutter and must be at least 525 mm away from live parts when the shutter has been inserted.

Type ISP 36 PVC ...	A1...
Part No.	763 211
Rated voltage (U _r)	Up to 36 kV
Material	Rigid PVC



Type A2

With 90° angled handle and hand grips for inserting or removing insulating protective shutters into / from guide rails by hand. Other angled handles (70° to 270°) are available on request.

The height of the handle has to be selected in such a way that live parts of the installation above the shutter are completely covered.

Type ISP 36 PVC ...	A2...
Part No.	763 221
Rated voltage (U _r)	Up to 36 kV
Material	Rigid PVC



Type A3

With retaining device with bayonet pin for inserting and removing insulating protective shutters into / from guide rails using an operating stick.

This shutter type is also available with a longitudinal slot and a retaining device (rotatable shutter). In this case, the shutter is operated using an operating stick with switching stick head. Two persons are required to insert / remove shutter sizes exceeding 1 m². For this purpose, two retaining devices for attaching operating sticks are required. Moreover, insulating protective shutters are also available with rolls.

Type ISP 36 PVC ...	A3...
Part No.	763 231
Rated voltage (U _r)	Up to 36 kV
Material	Rigid PVC



Type A4

With finger holes (without additional marks) for use in factory assembled switchgear panels. Instead of finger holes, the shutters are also available with a grip (minimum height: 35 mm).

The shutter is inserted through a slot into the closed installation.

The protective device of the installation must ensure full protection when inserting and removing the shutter. In type-tested switchgear installations in accordance with DIN VDE 0670-6 and 7 or EN/IEC 62271-200 (DIN VDE 0671-200), insulating protective shutters may only be used in consultation with the manufacturer of the switchgear installation.

Type ISP 36 PVC ...	A4...
Part No.	763 241
Rated voltage (U _r)	Up to 36 kV
Material	Rigid PVC









Guide rails and other accessories are listed in our template (DEHN Form No. 2090/E).



DEHN protects.

Live Working

Cleaning and Refilling Equipment / Protective and Auxiliary Equipment

Product	Type	Nominal voltage U_N / frequency f_N	Application, Indication	Page
TRS NS Dry Cleaning Kit				
	TRS NS	up to 1000 V / 15 ... 60 Hz	Live cleaning by suction Specially adapted operating heads for intensive cleaning Plug-in coupling system allows fast replacement of operating heads	119
TRS MS Dry Cleaning Kit				
	TRS MS TRS MS V1	up to 15 kV / 15 ... 60 Hz	Live cleaning by suction Transparent intake tubes for enhanced safety Specially adapted operating heads for intensive cleaning Plug-in coupling system allows fast replacement of operating heads	120
FRS ZK MS Damp Cleaning Kit				
	FRS ZK MS	up to 36 kV / 15 ... 60 Hz	Damp cleaning equipment for use under live conditions with special cleaning liquid Universal gear coupling for replacing and adjusting the angle of operating heads Plug-in operating heads allow fast and easy replacement of sponges	121
TFRS MS Combined Cleaning Kit				
	TFRS MS	up to 36 kV / 15 ... 60 Hz	Combined equipment for dry and damp cleaning Transparent intake tubes for enhanced safety Specially adapted operating heads for intensive cleaning Universal gear coupling for replacing and adjusting the angle of operating heads Plug-in operating heads allow fast and easy replacement of sponges	122
Hand Oiler for Switchgear Installations				
	HOEL 36 20 1100	up to 36 kV / 15 ... 60 Hz	For lubricating movable parts in switchgear installations with a nominal voltage up to 36 kV Transparent insulating hand oiler ensures increased safety Easy to use thanks to flexible tip	124
PPE – Personal Protective Equipment				
		up to 1000 V	Face shield NH fuse puller with sleeve Insulating gloves	125
Covering Material and Insulating Mats				
		up to 1000 V up to 50 kV	Covering material and wrapping tape Insulating mats for insulating the operating location	127 128
Maintenance Tests according to German regulations DGUV Vorschrift 3 (former BGV A3)				
			Operating sticks must be subjected to electrotechnical tests. Therefore, we recommend to test them with the prescribed limits as stated in the Electrical Safety Rules according to German regulations DGUV Vorschrift 3 (former BGV A3). This test includes: – measurement of the leakage current – test for protection against bridging, – visual inspection This maintenance test is documented in a test report and on the device. The test intervals depend on the operating conditions of the operating stick e.g. frequency of use, environmental conditions and transport. According to German regulations, however, it is advisable to carry out a maintenance test at least every 6 years .	144

Cleaning and Refilling Equipment

Live Working

Permanent availability of electricity has become a decisive factor in international competition. At the same time, power interruptions must be reduced as a result of the increasing cost pressure. This makes it difficult to ensure reliability of existing installations and to perform maintenance work as entire parts of the installation cannot be disconnected and the only alternative is live working. DEHN + SÖHNE has long-standing experience in the field of live working and has developed products which can be found in the DELTEC product range.

Disconnecting installations for maintenance work

Electrical equipment and low-voltage, medium-voltage and high-voltage systems such as overhead lines, transformer substations, switchgear installations, distribution boards, transformer cells or cable distribution cabinets cannot be disconnected or can only be disconnected with great effort due to undesired downtimes or costly work on Sundays and public holidays.

Live cleaning

Clean installations increase system reliability

In case of adverse weather conditions (moisture), soiled installations, dust layers and residues from lubricants on insulators and cable sealing ends in medium-voltage installations, cobwebs and weeds in cable distribution boards as well as dust and lubricant layers in low-voltage installations may cause arc faults, resulting in power failure, damage to the equipment and even injury or death.

Regular cleaning intervals

Surveys revealed that open indoor installations and cable distribution cabinets have to be cleaned at regular intervals between 6 months and 2 years depending on the type and degree of pollution.

Dry suction cleaning combined with damp cleaning

Dry cleaning work is performed by suction cleaning with operating heads or brushing soiled parts of the installation while simultaneously sucking the dirt away. Loose layers of dust and cobwebs are easily cleaned with little effort. Damp cleaning eliminates oily and tough pollutant layers with the help of sponges soaked with special insulating cleaning liquid. This type of work is performed according to the "hot stick working" procedure.

Dry suction cleaning equipment

Suction cleaning equipment consists of a cleaning head (operating heads, brushes), intake tube with handle, extension, intake hose and suction device.

All single parts are made of plastic and are fully insulated. The shape of the brushes and operating heads is largely adapted to the parts of installations to be cleaned.

The special plug-in coupling system of the dry cleaning equipment prevents accidental use of accessories not intended for this application (e.g. accessories of industrial vacuum cleaners).

Requirements on the vacuum cleaner

The vacuum cleaner used must meet the following requirements:

- The industrial vacuum cleaner must have a minimum air velocity of 20 m/s and a visual indication of the intake capacity.
- The intake hose must have a continuous inner diameter ≥ 30 mm and must not contain any metal parts.

Damp cleaning equipment

Damp cleaning equipment consists of special cleaning heads (sponge holders), an insulating stick with handle and extension elements. All single parts are fully insulated. The plug-in system of operating heads and sponges allows easy and fast replacement of dirty sponges. Only approved sponges may be used for this purpose.

Requirements on installers

Selection of electrically skilled persons for live working

Only electrically skilled persons with experience of several years in the operation and maintenance of electrical installations are allowed to perform maintenance and repair work. Electrically skilled persons must be theoretically and practically trained for this type of work.

Training as live worker

The training as specialised live worker is based on detailed target descriptions as required by the German professional association for precision and electrical engineering. It includes theoretical and practical training and a "live working" certificate upon completion of the training.

"Live working" procedure

During hot stick working, the worker keeps a predefined distance from live parts of the installation and uses insulating sticks/operating sticks.

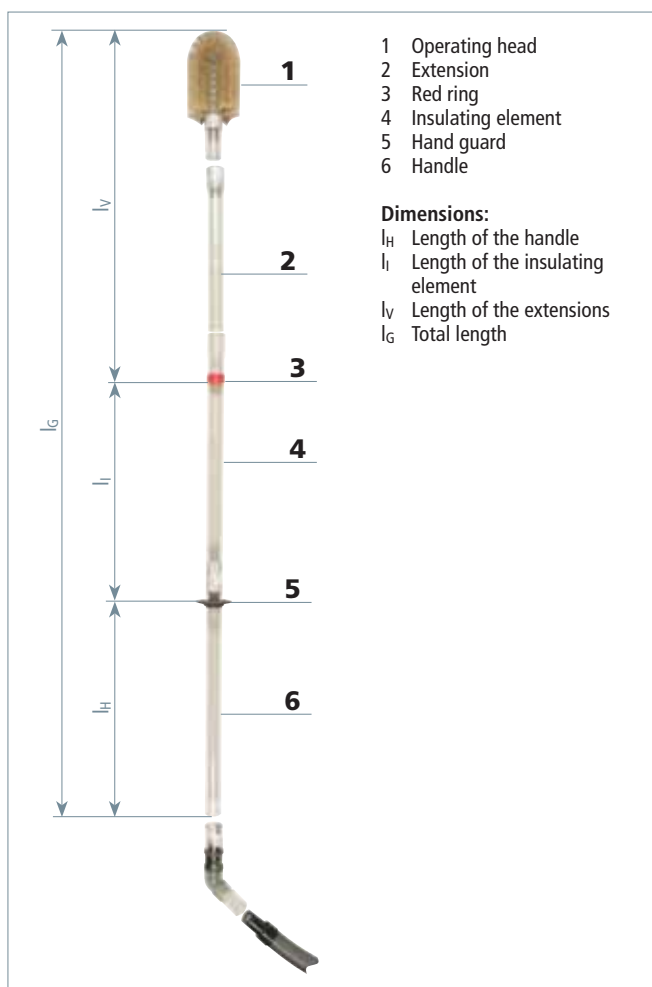

- 1 Operating head
- 2 Extension
- 3 Red ring
- 4 Insulating element
- 5 Hand guard
- 6 Handle

Dimensions:

- l_H Length of the handle
- l_i Length of the insulating element
- l_v Length of the extensions
- l_g Total length

Design

Cleaning and Refilling Equipment

TRS NS Dry Cleaning Kit

Nominal Voltages up to 1000 V / 15 ... 60 Hz

- For indoor and outdoor installations
- Equipment for suction cleaning under live conditions
- For dry cleaning of cable distribution cabinets, open indoor installations and control cabinets
- Specially adapted operating heads for intensive cleaning
- Plug-in coupling system allows fast replacement of operating heads
- Regulation of intake air in the handle area



General Information:

Standard	Based on DIN VDE 0682-621
Not suitable for use in wet weather conditions	



Live cleaning of a low-voltage switchgear installation using the TRS NS dry cleaning kit

Requirements

Cleaning work up to 1000 V must be carried out under supervision of a qualified electrician according to EN 50110-1 "Operation of electrical installations – Minimum Requirements". In Germany TRS NS dry cleaning kits are subject to DGUV Vorschrift 3 (former BGV A3) of the national

accident prevention regulations (UVV) "Elektrische Anlagen und Betriebsmittel" [Electrical installations and equipment] stipulated by the German Employer's Liability Association for the energy, textile, electrical and media product sector (BGEMEM).

TRS NS Dry Cleaning Kit

Fully equipped plastic case.



Kit includes:			
Pos.	Part No.	Pos.	Part No.
1	785 506	12	785 560
2	785 520	13	785 543
3	785 521	14	785 570
4	785 522	15	785 550
5	785 523	16	785 555
6	785 530	17	785 515
7	785 540	18	785 200
8	785 541	19	785 595
9	785 542	20	785 596
10	785 590	21	785 580
11	785 591	22	785 585

For more detailed information on these products, see www.dehn-international.com.

Type	TRS NS
Part No.	785 502
Dimensions	560 x 410 x 170 mm
Total length (l _{G max} / l _{G min})	1350 / 560 mm



Cleaning and Refilling Equipment

TRS MS Dry Cleaning Kit



Live cleaning of a transformer using the TRS MS dry cleaning kit

Nominal Voltages up to 36 kV / 15 ... 60 Hz

- For indoor and outdoor installations
- Equipment for live cleaning by means of suction
- For dry cleaning of transformers and switchgear installations
- Transparent intake tubes ensure enhanced safety
- Specially adapted operating heads for intensive cleaning
- Plug-in coupling system allows fast replacement of operating heads



General Information:

Standard	DIN VDE 0682-621
Not suitable for use in wet weather conditions	

Requirements

Cleaning work from 1 to 36 kV must be carried out under supervision of a qualified electrician according to EN 50110-1 "Operation of electrical installations – Minimum Requirements", observing clauses 6.3.1 to 6.3.12. In Germany TRS MS dry cleaning kits are subject to DGUV Vorschrift 3 (former BGV A3) and DGUV Regel 103-011 (former BGR A3) of the national accident prevention regulations (UVV) "Elektrische Anlagen und Betriebsmittel" [Electrical installations and equipment] stipulated by the German Employer's Liability Association for the energy, textile, electrical and media product sector (BGETEM).

TRS MS / TRS MS V1 Dry Cleaning Kit

Fully equipped GRP case.

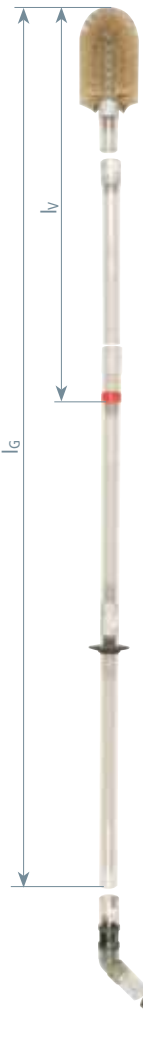

TRS MS Kit includes:

Pos.	Part No.	Pos.	Part No.
1	785 301	19	785 140
5	785 131	20	785 150
6	785 132	21	785 170
7	785 130	25	785 220
10	785 120	26	785 221
15	2x 785 121	39	785 200
16	2x 785 122	42	785 180
17	2x 785 123	44	785 190
18	785 160		

For more detailed information on these products, see www.dehn-international.com.

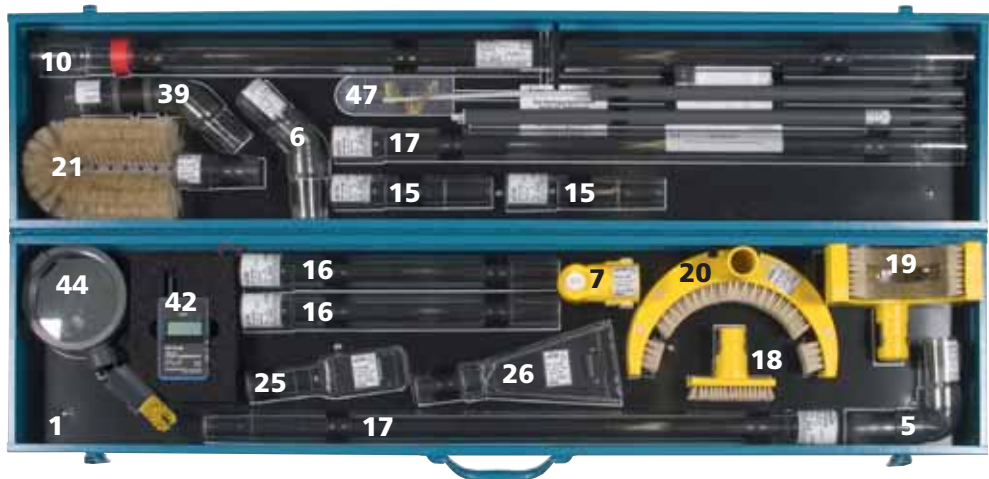

TRS MS V1 Kit includes:

Pos.	Part No.	Pos.	Part No.
1	785 301	21	785 170
5	785 131	22	785 171
6	785 132	23	785 172
7	785 130	25	785 220
10	785 120	26	785 221
15	2x 785 121	39	785 200
16	2x 785 122	40	785 212
17	785 123	42	785 180
18	785 160	44	785 190
19	785 140	47	785 210

For more detailed information on these products, see www.dehn-international.com.



Type TRS ...	MS	MS V1
Part No.	785 100	785 112
Dimensions	1260 x 305 x 205 mm	1260 x 305 x 205 mm
Total length (lg max / lg min)	3580 / 1180 mm	3580 / 1180 mm
Extension (lv max / lv min)	2515 / 115 mm	2515 / 115 mm

Note: The Pos. Nos. highlighted in grey indicate the differences between the dry cleaning kits.

Cleaning and Refilling Equipment

FRS ZK MS Damp Cleaning Kit

Nominal Voltages up to 36 kV / 15 ... 60 Hz

- For indoor and outdoor installations
- Damp cleaning equipment for use under live conditions with special cleaning liquid
- Universal gear coupling for replacing and adjusting the angle of operating heads
- Rigid and flexible plug-in operating heads allow fast and easy replacement of the sponges



General Information:	
Standard	Based on DIN VDE 0681-1 and DIN VDE 0682-621
Standard (universal gear coupling)	EN/IEC 60832 (DIN VDE 0682-211)
Not suitable for use in wet weather conditions	

Application

Damp sponges allow to remove tough pollution layers and to clean oily transformer surfaces. Special insulating cleaning liquids (e.g. Rivolta SLX 500; SLX TOP or SLX Super from Bremer & Leguil, Duisburg/Germany, and Florin 2000 from Flore, Koblenz/Germany) must be selected according to the rated voltage of the installation and the environmental conditions.



Damp cleaning of a transformer using the FRS ZK MS damp cleaning kit

Requirements

Cleaning work from 1 to 36 kV must be carried out under supervision of a qualified electrician according to EN 50110-1 "Operation of electrical installations – Minimum Requirements", observing clauses 6.3.1 to 6.3.12. In Germany FRS ZK MS damp cleaning kits are subject to DGUV Vorschrift 3 (former BGV A3) and DGUV Regel 103-011 (former BGR A3) of the national accident prevention regulations (UVV) "Elektrische Anlagen und Betriebsmittel" [Electrical installations and equipment] stipulated by the German Employer's Liability Association for the energy, textile, electrical and media product sector (BGEMEM).

FRS ZK MS Damp Cleaning Kit

Fully equipped GRP case.



Kit includes:			
Pos.	Part No.	Pos.	Part No.
2	785 229	32	785 324
8	785 315	33	785 322
11	785 316	34	785 323
12	785 317	35	785 274
13	785 318	36	785 275
14	785 319	37	785 279
30	785 320	38	785 280
31	785 321		

For more detailed information on these products, see www.dehn-international.com.

Type	FRS ZK MS
Part No.	785 940
Dimensions	945 x 285 x 170 mm
Total length (l _{G max} / l _{G min})	3250 / 1450 mm
Extension (l _{G max} / l _{G min})	2100 / 350 mm

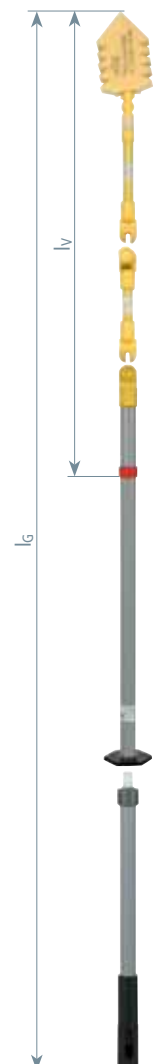

Cleaning and Refilling Equipment

TFRS MS Combined Cleaning Kit



TFRS MS combined cleaning kit used for dry and damp cleaning of a transformer under live conditions

TFRS MS Combined Cleaning Kit

Fully equipped GRP case and leather bag.

Kit includes – Case:

Pos.	Part No.	Pos.	Part No.
3	785 951	27	785 223
5	785 131	28	785 551
6	785 132	29	785 552
7	785 130	30	785 320
11	785 316	31	785 321
12	785 317	32	785 324
13	785 318	33	785 322
14	2x 785 319	34	785 323
15	785 121	35	785 274
16	785 122	36	785 275
17	2x 785 123	37	785 279
18	785 160	38	785 280
19	785 140	39	785 200
20	785 150	40	785 212
21	785 170	41	785 259
22	785 171	43	785 181
23	785 172	44	785 190
24	785 151	45	785 953
25	785 220	46	785 224
26	785 221		

Kit includes – Bag:

Pos.	Part No.	Pos.	Part No.
4	785 952	47	785 210
9	785 325	48	785 585
10	785 120	49	785 109

For more detailed information on these products, see www.dehn-international.com.

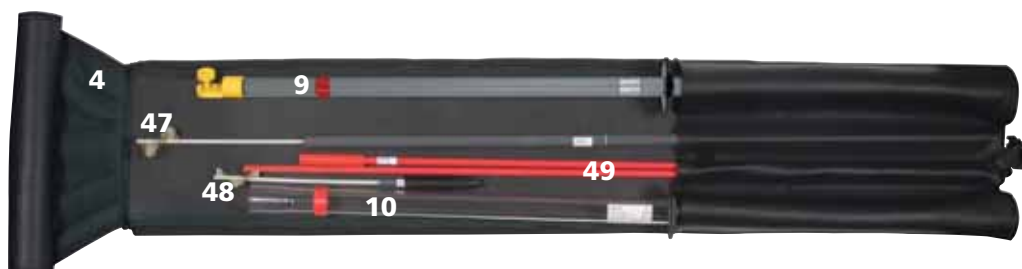

Nominal Voltages up to 36 kV / 15 ... 60 Hz

- For indoor and outdoor installations
- Combined dry and damp cleaning kit for cleaning under live conditions
- Transparent intake tubes ensure enhanced safety
- Specially adapted operating heads for intensive cleaning
- Universal gear coupling for replacing and adjusting the angle of operating heads
- Rigid and flexible plug-in operating heads allow fast and easy replacement of the sponges



General Information:

Standard	Based on DIN VDE 0681-1 and DIN VDE 0682-621
Standard (universal gear coupling)	EN/IEC 60832 (DIN VDE 0682-211)
Not suitable for use in wet weather conditions	☀

Application

Dry cleaning work is performed by suction cleaning with operating heads or brushing soiled parts of the installation while simultaneously sucking the dirt away. Loose dust layers and cobwebs are easily removed with little effort. Damp cleaning eliminates oily and tough contaminants with the help of sponges soaked with special insulating cleaning liquids.

Requirements

Cleaning work from 1 to 36 kV must be carried out under supervision of a qualified electrician according to EN 50110-1 "Operation of electrical installations – Minimum Requirements", observing clauses 6.3.1 to 6.3.12. In Germany TFRS MS combined cleaning kit are subject to DGUV Vorschrift 3 and DGUV Regel 103-011 (previously BGV A3 and BGR A3) of the national accident prevention regulations (UVV) "Elektrische Anlagen und Betriebsmittel" [Electrical installations and equipment] stipulated by the German Employer's Liability Association for the energy, textile, electrical and media product sector (BGETEM).

Type	TFRS MS
Part No.	785 950
Dimensions (bag)	1400 x 280 mm
Dimensions (case)	900 x 415 x 430 mm

Cleaning and Refilling Equipment

Accessories for NS and MS Cleaning Kits

Industrial Vacuum Cleaner

For dry and combined cleaning kits.

Equipment:

25 l special plastic container, 2 large wheels, 2 guide wheels with locking brakes, handle and cable holder, socket outlet with automatic switch-on mechanism, electromagnetic pulse filter cleaning, automatic vibration function, speed control, volume flow control, acceleration rate controller, electronic running feature, moisture identification with sensor-controlled disconnection, 2 new polyester filter cassettes, FKP 4300, filter area $2 \times 4300 \text{ cm}^2 = 8600 \text{ cm}^2$, dust collection capacity 99.99 %, class L in accordance with DIN EN 60335-2-69 Annex AA, cord length 8 m.

Technical data:

- Intake hose with straight connecting adapter $\text{Ø}35 \text{ mm}$, 5 m long

Type	HISC 1600
Part No.	785 310
Dimensions	430 x 390 x 490 mm



Reducing Inserts

For connection between SSA W D intake hose adapter and intake hoses from other manufacturers with different diameters and straight connecting adapter.

General Information:				
Total length	105 mm			
Type	RSI 32	RSI 34	RSI 35	RSI 38
Part No.	785 213	785 214	785 215	785 216
Diameter	35 / 32 mm	35 / 34 mm	35 / 35 mm	35 / 38 mm
Type	RSI 45	RSI 51	RSI 58	
Part No.	785 217	785 218	785 219	
Diameter	35 / 45 mm	35 / 51 mm	35 / 58 mm	

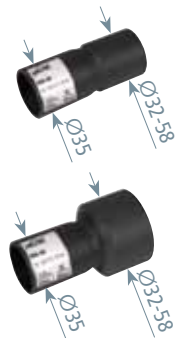

Application:

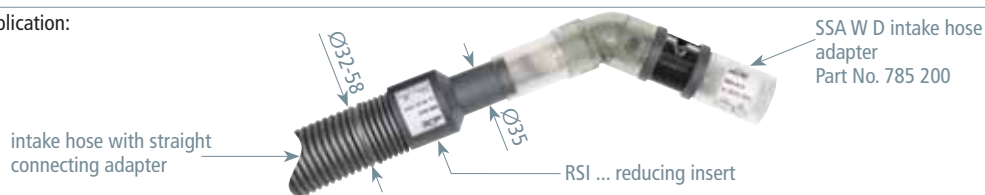

Cleaning Head 55 with Scraper

For TRS MS and TFRS MS.
Including 3 spare scrapers.

Type	FD 60 MS SN7271
Part No.	785 225
Diameter	40 mm
Total length	190 mm



90° Angled Flat Cleaning Head with Detachable Brush

For TRS NS dry cleaning kits.

Type	FWD 35 P NS
Part No.	785 592
Diameter	25 mm
Total length	200 mm



Intake Tube with Handle

For TRS MS and TFRS MS cleaning kits.

Type	SRH 1180 IS 650 MS
Part No.	785 119
Diameter	40 mm
Total length	1180 mm, insulating element 650 mm



Canvas Bag, empty

With two separate internal pockets and carrier handle.

Type	STT 55 27 30
Part No.	785 111
Colour	Olive ●
Dimensions	550 x 270 x 300 mm

Cleaning and Refilling Equipment

Hand Oiler for Switchgear Installations



Nominal Voltages up to 36 kV

- For lubricating movable parts in switchgear installations with a nominal voltage up to 36 kV
- Transparent insulating hand oiler ensures increased safety
- Easy to use thanks to flexible tip
- If required, the insertion depth of the hand oiler can be increased by means of optional extensions



General Information:

Standard	Based on DIN VDE 0681-1 and DIN VDE 0682-621
Temperature range	+5 °C ... +50 °C
Not suitable for use in wet weather conditions	

Hand Oiler

NEW

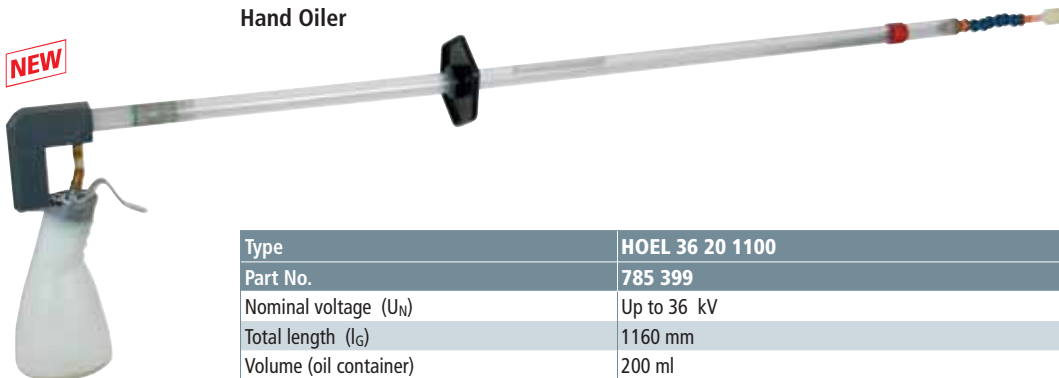

Type	HOEL 36 20 1100
Part No.	785 399
Nominal voltage (U _N)	Up to 36 kV
Total length (l _G)	1160 mm
Volume (oil container)	200 ml

Accessories for Hand Oiler for Switchgear Installations

Extension for Hand Oiler



Type	VL HOEL 20 500
Part No.	785 398
Nominal voltage (U _N)	Up to 36 kV
Total length (l _G)	500 mm
Diameter	20 mm

Protective and Auxiliary Equipment

PPE – Personal Protective Equipment

Nominal Voltages up to 1000 V

- For working on live parts
- Insulating gloves combine excellent fit and high elasticity with maximum insulation strength
- Two different models to suit your needs

General Information:

Standard (gloves)	EN 60903 (DIN VDE 0682-311)
Standard (face shield)	DIN EN 166 and additional requirements; GS-ET-29 by the trade association
Standard (NH fuse handle)	DIN VDE 0680-4; GS-ET-29 by the trade association



Live working with insulating gloves up to 1000 V

Face Shield with Strap

- Coating on both sides prevents misting up, polished edges
- The face shield can be locked into the use and non-use position
- Suitable for all common safety helmets for electricians

Type	SSC ASH NS
Part No.	785 427
Nominal voltage up to (U_N)	1000 V
Wall thickness	1.5 mm
Size	Universal
Material	Plastic
Incident energy after box test	(class 1) 135 kJ / m ²
Visible Light Transmittance (VLT)	> 75 %



NH Fuse Handle with Sleeve

- For actuating NH fuses of sizes 00, 1, 2 and 3

Type	NHS AG 00 3 NS
Part No.	785 645
Nominal voltage up to (U_N)	1000 V
Colour	Brown ●
Material	Coated cotton fabric



Protective and Auxiliary Equipment

Insulating Gloves, Category M

For high mechanical stress



Type	IHS 00 M 9 NS	IHS 00 M 10 NS	IHS 0 M 9 NS	IHS 0 M 10 NS
Part No.	785 491	785 492	785 493	785 494
Class	00	00	0	0
Nominal voltage up to (U _N)	500 V	500 V	1000 V	1000 V
Colour	Beige ●	Beige ●	Beige ●	Beige ●
Wall thickness	0.5 mm	0.5 mm	1.0 mm	1.0 mm
Size	9	10	9	10

Insulating Gloves, Category RC

Resistant to acid, oil, ozone, high mechanical stress and extremely low temperatures.
With inner coating and textured gripping surface.



Type	IHS 00 RC 9 NS	IHS 00 RC 10 NS
Part No.	785 495	785 496
Class	00	00
Nominal voltage up to (U _N)	500 V	500 V
Colour	Orange ●	Orange ●
Wall thickness	0.9 mm	0.9 mm
Size	9	10

Accessories for PPE – Personal Protective Equipment

Storage Bag, empty

With hook-and-loop fastener and hook.



Type	AT IHS NS
Part No.	785 490
Colour	Brown ●
Dimensions	400 x 180 x 50 mm

Pneumatic Glove Tester

For performing tests required by the standard.



Type	PHSP NS
Part No.	785 497
Colour	Grey ●

Protective and Auxiliary Equipment

Covering Material and Insulating Mats

- Protection against accidental and direct contact with live parts
- For covering adjacent live parts
- Available in different lengths, widths, thicknesses and colours
- Insulating rubber mats for insulating the operating location



Covering live parts

General Information:

Standard	Covering material: EN/IEC 61112 (DIN VDE 0682-511); Insulated mats: EN/IEC 61111 (DIN VDE 0682-512)
----------	--------------------------------------------------------------------------------------------------------

Covering Material (Crystal Clear Plastic)

Type	ATK 135 50M NS	ATK 135 ..M NS
Part No.	785 465	785 466
Class	0	0
Nominal voltage up to (U _N)	1000 V	1000 V
Length	50 m	Any up to 50 m *)
Width	1350 mm	1350 mm
Thickness	0.5 mm	0.5 mm
Colour	Crystal clear	Crystal clear

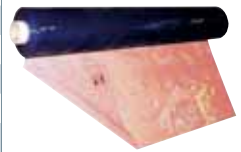

Covering Material (Transparent Plastic)

Type	ATK 120 25M NS	ATK 120 ..M NS
Part No.	785 467	785 468
Class	0	0
Nominal voltage up to (U _N)	1000 V	1000 V
Length	25 m	Any up to 25 m *)
Width	1200 mm	1200 mm
Thickness	1.0 mm	1.0 mm
Colour	Transparent	Transparent



Covering Material (EPDM Elastomer)

With VDE / GS label, flexible at low temperatures.

Type	ATN 140 10M NS	ATN 140 ..M NS
Part No.	785 471	785 472
Class	0	0
Nominal voltage up to (U _N)	1000 V	1000 V
Length	10 m	Any up to 10 m *)
Width	1400 mm	1400 mm
Thickness	1.0 mm	1.0 mm
Colour	Red ●	Red ●



Protective and Auxiliary Equipment

Wrapping Tape (EPDM Elastomer)

For covering insulators.



Type	WBN 200 2,5M NS
Part No.	785 646
Class	0
Nominal voltage up to (U _N)	1000 V
Length	2.5 m
Width	200 mm
Thickness	1.0 mm
Colour	Red ●

Insulating Rubber Mats for Insulating the Operating Location



Type	IMG SI 1M NS	IMG SI 10M NS	IMG SI ..M NS
Part No.	785 455	785 457	785 456
Class	0	0	0
Nominal voltage up to (U _N)	1000 V	1000 V	1000 V
Length	1 m	10 m	Any up to 10 m *)
Width	1000 mm	1000 mm	1000 mm
Thickness	3.0 mm	3.0 mm	3.0 mm
Colour	Grey ●	Grey ●	Grey ●

Insulating Mats up to 50 kV

For use in electrical switch and test rooms.

Dielectric strength of 50 kV, tested according to DIN VDE 0303-21.

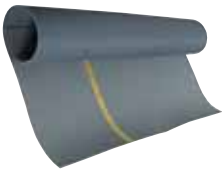

Type	IMG SAN 1M 10M	IMG SAN 1M ..M
Part No.	785 459	785 458
Nominal voltage up to (U _N)	50 kV	50 kV
Length	10 m	Any up to 10 m *)
Width	1000 mm	1000 mm
Thickness	4.5 mm	4.5 mm
Colour	Grey ●	Grey ●

*) Required length to be specified at order!

Accessories for Covering Material and Insulating Mats



Clip

With insulated steel spring.

Type	KK 35 NS
Part No.	785 647
Max. clamping range	35 mm
Dimensions	170 / 110 mm
Material	Plastic



Hook

Type	HK 8 NS
Part No.	785 648
Dimensions	Ø8, 126 / 72 mm
Material	Plastic



Eye

Two-piece

Type	OEK 12 NS
Part No.	785 649
Dimensions	Ø12 / 26 mm
Material	Plastic

Arc Fault Protection

Product	Application	Page
Passive Arc Fault Protection – DEHNcare® APG		
	Arc-fault-tested protective gloves	130
Passive Arc Fault Protection – DEHNcare® APJ, APT and APC		
	Arc-fault-tested protective coat	131
Passive Arc Fault Protection – DEHNcare® ESH U		
	Insulating safety helmet for electricians (EN 50365) Six-point suspension with sweatband	133
Passive Arc Fault Protection – DEHNcare® APS		
	Arc-fault-tested face shield, suitable for all standard safety helmets for electricians	134
Active Arc Fault Protection – Arc Fault Protection System		
	DEHNarc protects persons from the effects of an arc during live working Fixed Arc Fault Protection System DEHNshort Mobile Arc Fault Protection System DEHNarc	135 139
Active Arc Fault Protection – Light Sensor Supports and Support Rails for DEHNarc		
	Supports for installing the mobile arc fault protection system	142

Passive Arc Fault Protection – DEHNcare®

DEHNcare® APG



Actuation of an NH fuse puller using protective gloves

Protective Gloves

Prevent injuries – Stay healthy

- For protection against thermal and mechanical risks
- Excellent fit due to special glove cut
- Good touch sensitivity due to soft leather glove palm
- Breathable materials maximise wearing comfort
- Certified according to the requirements of the 89/686/EEC directive on personal protective equipment

General Information:

Standard	Box test in accordance with IEC 61482-1-2; ATPV test in accordance with IEC 61482-1-1; DIN EN 388, DIN EN 407
Material (glove palm)	Siliconised calf grain leather
Material (glove back)	100% Kevlar® interlock knit
Material (sewing thread)	Kevlar®

Measure correctly



Glove size

Size	Circumference around your knuckles
8	20.3 cm
9	22.9 cm
10	25.4 cm
11	27.9 cm
12	30.5 cm

Glove size

Measure the circumference around your knuckles to determine your correct glove size.

Example

For a knuckle circumference of 24 cm, you would choose a size 10.

Notes

Article 5 of the German Occupational Health and Safety Act requires employers to perform a hazard analysis.

This hazard analysis also involves arc fault protection.

Employers must select and provide approved protective clothing including helmets, face shields and gloves to protect personnel against the hazards of arc faults.

They must also ensure that each employee who is exposed to the hazards of arc faults wears protective clothing.

Protective gloves of type APG are no insulating gloves in accordance with EN/IEC 60903 (DIN VDE 0682-311) for live working.

Arc-fault-tested Protective Gloves

General Information:

Direct incident energy (E_{io})	(class 2) 423 kJ / m ²
Extended direct incident energy (E_{ie})	(class 2*) 1050 ... 1390 kJ / m ²
Arc energy (W_{arc})	318 kJ
ATPV (Arc Thermal Performance Value)	32.8 cal / cm ²
Gauntlet length	100 mm



Type APG ...	8	9	10	11	12
Part No.	785 796	785 797	785 798	785 799	785 800
Total length	310 mm	320 mm	330 mm	340 mm	350 mm
Size	8	9	10	11	12

*) The distance of the specimen was reduced from 300 mm to 150 mm based on IEC 61482-1-2.

Arc-fault-tested Protective Gloves with long Gauntlet

General Information:

Direct incident energy (E_{io})	(class 2) 423 kJ / m ²
Extended direct incident energy (E_{ie})	(class 2*) 1050 ... 1390 kJ / m ²
Arc energy (W_{arc})	318 kJ
ATPV (Arc Thermal Performance Value)	32.8 cal / cm ²
Gauntlet length	230 mm

NEW



Type APG ...	8 L	9 L	10 L	11 L	12 L
Part No.	785 808 <small>NEW</small>	785 809 <small>NEW</small>	785 810 <small>NEW</small>	785 811 <small>NEW</small>	785 812 <small>NEW</small>
Total length	430 mm	440 mm	450 mm	460 mm	470 mm
Size	8	9	10	11	12

*) The distance of the specimen was reduced from 300 mm to 150 mm based on IEC 61482-1-2.

Passive Arc Fault Protection – DEHNcare®

DEHNcare® APJ, APT and APC

Protective Jackets, Protective Trousers and Protective Coats

Prevent injuries – Stay healthy

- Breathable leather ensures high wearing comfort
- Flame-retardant zip and hook-and-loop fasteners
- Reflective strips
- Certified in compliance with the 89/686/EEC directive on personal protective equipment

General Information:

Standard	Box test in accordance with IEC 61482-1-2; EN ISO 14116
Outer material	Siliconised calf grain leather, 100% Kevlar® interlock knit
Inner material	100% cotton
Material (sewing thread)	100% Kevlar®



Attaching an earthing and short-circuiting device using adequate personal protective equipment

Measure correctly

A Body height Stand without shoes, e.g. at a wall and measure from tip to toe.
B Chest circumference Measure horizontally at the largest width of chest.
C Waist circumference Measure horizontally around the waist.
D Hip circumference Measure horizontally at the largest width of back.
E Inner leg length Measure along the leg from crotch to the ground.

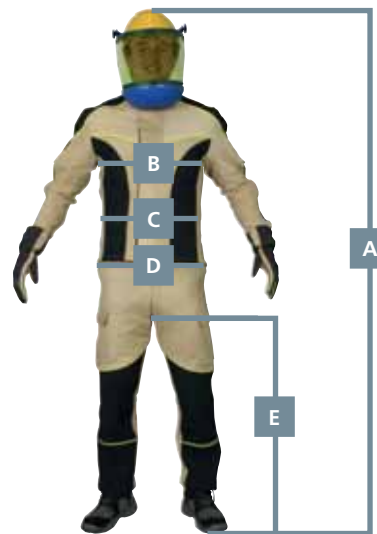

Part No.	Size	A Body height	B Chest circumference	C Waist circumference	D Hip circumference	E Inner leg length
Arc-fault-tested Protective Jacket and Trousers						
785 769 / 785 779	46 / S	169-174 cm	92-95 cm	79-82 cm	92-95 cm	77.5-80 cm
785 770 / 785 780	48 / M	172-177 cm	96-100 cm	83-86 cm	96-99 cm	79-81.5 cm
785 771 / 785 781	50 / M	175-180 cm	101-103 cm	87-90 cm	100-103 cm	80.5-83 cm
785 772 / 785 782	52 / L	178-183 cm	104-107 cm	91-94 cm	104-107 cm	82-84.5 cm
785 773 / 785 783	54 / XL	180-185 cm	108-111 cm	95-98 cm	108-111 cm	83-85.5 cm
785 774 / 785 784	56 / XXL	182-187 cm	112-115 cm	99-102 cm	112-115 cm	84-86.5 cm
785 775 / 785 785	58 / XXXL	184-189 cm	116-119 cm	103-107 cm	116-119 cm	85-87.5 cm
Arc-fault-tested Protective Coat						
785 755	48 / 50	172-180 cm	96-103 cm	83-90 cm	—	—
785 756	52 / 54	178-185 cm	104-111 cm	91-98 cm	—	—
785 757	56 / 58	182-189 cm	112-119 cm	99-107 cm	—	—
785 758	60 / 62	186-191 cm	120-127 cm	108-117 cm	—	—

Passive Arc Fault Protection – DEHNcare®

Arc-fault-tested Protective Coat

- Reinforced stand-up collar
- Useful side arm pockets
- Zip and hook-and-loop fasteners



Type	APC 48 50	APC 52 54	APC 56 58	APC 60 62
Part No.	785 755	785 756	785 757	785 758
Direct incident energy (E_{i0})	(class 2) 423 kJ / m ²	(class 2) 423 kJ / m ²	(class 2) 423 kJ / m ²	(class 2) 423 kJ / m ²
Extended direct incident energy (E_{i0})	(class 2*) 1050 ... 1390 kJ / m ²	(class 2*) 1050 ... 1390 kJ / m ²	(class 2*) 1050 ... 1390 kJ / m ²	(class 2*) 1050 ... 1390 kJ / m ²
Arc energy (W_{arc})	318 kJ	318 kJ	318 kJ	318 kJ
ATPV (Arc Thermal Performance Value)	33.1 cal / cm ²	33.1 cal / cm ²	33.1 cal / cm ²	33.1 cal / cm ²
Size	48 / 50	52 / 54	56 / 58	60 / 62

*) The distance of the specimen was reduced from 300 mm to 150 mm based on IEC 61482-1-2.

If the protective coat is heavily soiled, it can be dry cleaned in a leather cleaner's.

Arc-fault-tested Protective Jacket

- Reinforced stand-up collar
- Useful side arm pockets
- Zip and hook-and-loop fastener



General Information:	
Direct incident energy (E_{i0})	(class 2) 423 kJ / m ²
Extended direct incident energy (E_{i0})	(class 2*) 1050 ... 1390 kJ / m ²
Arc energy (W_{arc})	318 kJ
ATPV (Arc Thermal Performance Value)	33.1 cal / cm ²

Type	APJ 46	APJ 48	APJ 50	APJ 52
Part No.	785 769	785 770	785 771	785 772
Size	46	48	50	52

Type	APJ 54	APJ 56	APJ 58
Part No.	785 773	785 774	785 775
Size	54	56	58

*) The distance of the specimen was reduced from 300 mm to 150 mm based on IEC 61482-1-2.

If the protective jacket is heavily soiled, it can be dry cleaned in a leather cleaner's.

Arc-fault-tested Protective Trousers

- Knee pads and pair of braces included
- Pockets for knee pads
- Adjustable belt



General Information:	
Direct incident energy (E_{i0})	(class 2) 423 kJ / m ²
Extended direct incident energy (E_{i0})	(class 2*) 1050 ... 1390 kJ / m ²
Arc energy (W_{arc})	318 kJ
ATPV (Arc Thermal Performance Value)	29.2 cal / cm ²

Type	APT 46	APT 48	APT 50	APT 52
Part No.	785 779	785 780	785 781	785 782
Size	46	48	50	52

Type	APT 54	APT 56	APT 58
Part No.	785 783	785 784	785 785
Size	54	56	58

*) The distance of the specimen was reduced from 300 mm to 150 mm based on IEC 61482-1-2.

If the protective trousers are heavily soiled, they can be dry cleaned in a leather cleaner's.

Accessories for DEHNcare® APJ, APT and APC

Pair of Braces (1)

For arc-fault-tested protective trousers with four hook-and-loop fasteners.

Type	APA B
Part No.	785 788
Colour	Black ●

Knee Pads (2)

For arc-fault-tested protective trousers, to be inserted into the lining of the trouser legs (slit pockets).

Type	APA KP
Part No.	785 789
Material	Foam

Passive Arc Fault Protection – DEHNcare®

ESH U Safety Helmet for Electricians

Nominal voltages up to 1000 V

- Electrically insulating safety helmet for electricians (EN 50365)
- For nominal voltages up to 1000 V
- With slot for APS ... SC face shield
- Adjustable to head sizes from 51 to 63 cm via push / rotary knob
- Six-point suspension with sweatband
- ABS plastic shell



General Information:

Standard	EN 397 and EN 50365
----------	---------------------

ESH U

General Information:

Nominal voltage up to (U _N)	1000 V
Material	ABS plastics
Standard	EN 397 and EN 50365

Type ESH U 1000 S ...	Y	W	O	B	R
Part No.	785 730 ^{NEW}	785 731 ^{NEW}	785 732 ^{NEW}	785 733 ^{NEW}	785 734 ^{NEW}
Colour	Yellow ●	White ○	Orange ●	Blue ●	Red ●

NEW



Accessories for ESH U Safety Helmet for Electricians

Chin Strap

For safety helmets for electricians ESH U 1000, adjustable.

Type	KR ESH U 1000
Part No.	785 738
Colour	Black ●
PU	10 pc(s)

NEW



Sweatband

Replacement part for ESH U 1000 safety helmet for electricians.

Type	SB ESH U 1000
Part No.	785 739
Material	Hydro-flock (S31F) PVC (S31P)
PU	10 pc(s).

NEW



Passive Arc Fault Protection – DEHNcare®

DEHNcare® APS

Prevent injuries – Stay healthy

- Protection even if scratched
- Anti-mist
- Cost saving long service life
- Transparent chin protector provides all-round visibility

General Information:

Standard

EN 166 and EN 170, GS-ET-29;
box test according to IEC 61482-1-2;
ATPV test according to IEC 61482-1-1;
ASTM F2178

NEW



Arc-fault-tested Face Shield with Clip and Transparent Chin Protector

- Fits the slot in the ESH U safety helmet for electricians

Type APS ...	T CL2 SC	T 12C SC	T 20C SC
Part No.	785 761 ^{NEW}	785 762 ^{NEW}	785 763 ^{NEW}
Nominal voltage up to (U _N)	1000 V	1000 V	1000 V
Material	Plastic	Plastic	Plastic
Wall thickness	1.5 mm	1.5 mm	1.5 mm
Incident energy after box test	(class 2) 423 kJ / m ²	(class 2) 423 kJ / m ²	(class 2) 423 kJ / m ²
Arc thermal performance value (ATPV)	—	12 cal / cm ²	20 cal / cm ²
Visible light transmittance (VLT)	>> 75 %	58.1 ... 74.4 %	43.2 ... 58.1 %

NEW



Arc-fault-tested Face Shield with Strap and Transparent Chin Protector

- Suitable for all standard safety helmets for electricians

Type APS ...	T CL2 FS	T 12C FS	T 20C FS
Part No.	785 764 ^{NEW}	785 765 ^{NEW}	785 766 ^{NEW}
Nominal voltage up to (U _N)	1000 V	1000 V	1000 V
Material	Plastic	Plastic	Plastic
Wall thickness	1.5 mm	1.5 mm	1.5 mm
Incident energy after box test	(class 2) 423 kJ / m ²	(class 2) 423 kJ / m ²	(class 2) 423 kJ / m ²
Arc thermal performance value (ATPV)	—	12 cal / cm ²	20 cal / cm ²
Visible light transmittance (VLT)	>> 75 %	58.1 ... 74.4 %	43.2 ... 58.1 %

Arc-fault-tested Face Shield with Clip and Chin Protector

- Fits the slot in the ESH U safety helmet for electricians



Type APS ...	CL2 SC	12C SC
Part No.	785 746	785 747
Nominal voltage up to (U _N)	1000 V	1000 V
Material	Plastic	Plastic
Wall thickness	1.5 mm	1.5 mm
Incident energy after box test	(class 2) 423 kJ / m ²	(class 2) 423 kJ / m ²
Arc thermal performance value (ATPV)	—	12 cal / cm ²
Visible light transmittance (VLT)	> 75 %	65 ... 75 %

Arc-fault-tested Face Shield with Strap and Chin Protector

- Suitable for all standard safety helmets for electricians



Type APS ...	CL2 FS	12C FS
Part No.	785 748	785 749
Nominal voltage up to (U _N)	1000 V	1000 V
Material	Plastic	Plastic
Wall thickness	1.5 mm	1.5 mm
Incident energy after box test	(class 2) 423 kJ / m ²	(class 2) 423 kJ / m ²
Arc thermal performance value (ATPV)	—	12 cal / cm ²
Visible light transmittance (VLT)	> 75 %	65 ... 75 %

Accessories for DEHNcare® APS



Visor Holder with Clip

For arc-fault-tested face shields with clip; APS CL2 SC / APS 12C SC.

Type	VH SC APS
Part No.	785 753
Material	Plastic

Active Arc Fault Protection

Fixed Arc Fault Protection System DEHNshort

- Protection of persons and installations
- Maximum availability of installations
- Modular system design
- System status is indicated at the front of the installation

NEW

General Information:	
Nominal voltage (Ue)	400 V a.c.
Short-circuit current of the short-circuiter (I _{cw})	80 kA, 50 ms
Arc current threshold (I _{parc})	5 kA
Ambient temperature of the light sensors (during operation)	-20 °C ... +85 °C
Ambient temperature of the detection devices (during operation)	-35 °C ... +70 °C
Ambient temperature of the short-circuiter (during operation)	-5 °C ... +55 °C
Typical arc fault extinction times (t _b)	3 ms at 65 kA

DEHNshort optimally protects persons and switchgear installations from the effects of an arc fault. To achieve this, particularly short response times are required in high-energy switchgear installations. Just a few milliseconds are decisive for the intensity and the effects of an arc fault. DEHNshort detects the arc fault the moment it starts to develop, evaluates the detected sensor signals and quenches the arc fault by generating a three-phase bolted short-circuit.

Functional principle:

Detection

The protection transformers situated upstream of the feeder circuit breakers detect the overcurrent resulting from the arc fault in all infeeds. Special light sensors detect the extremely bright light of the arc fault. Depending on the requirements of the relevant switchgear installation, light sensors are available as point sensors or fibre optic sensors.

Evaluation

Electronic detection devices link the sensor signals and activate the short-circuiters of the relevant busbar as well as the shunt releases of all feeder circuit breakers in case of both detection parameters.



Built-in protection transformers



Built-in light sensors



Detection devices integrated in the door



Short-circuiter above the supply switch



Fixed arc fault protection system DEHNshort

Quenching

As soon as the short-circuiter is activated, a bolted short-circuit is generated in parallel to the arc fault within a short period of time. Due to this low-impedance bypass, the voltage drops and the arc fault is quenched immediately. Thyristors short-circuit the three phases of the busbar directly after the short-circuiter has been activated. Subsequently, a spring-driven contact system carries the short-circuit current until the installation is disconnected by the feeder circuit breakers.

Isolation

To ensure that the switchgear installation is not loaded with the short-circuit current for longer than necessary – and to ensure additional safety – a disconnection command is transmitted to the relevant shunt release of all feeder circuit breakers via floating contacts. This means that the busbar section where the arc fault occurred is already isolated from the system.

Re-commissioning

The switchgear installation can be immediately re-commissioned after the fault has been rectified and the short-circuiters have been replaced. The arc fault protection system significantly exceeds the requirements of test criteria 1-7 of IEC TR 61641 ed3 of 2014. DEHNshort is used wherever the protection of persons and availability of the power supply is vital.

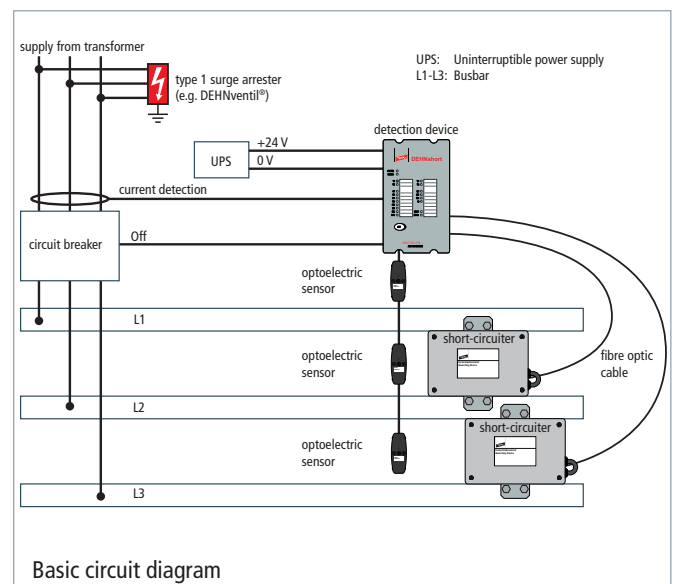

Basic circuit diagram

Active Arc Fault Protection

Detection Device (Current+Light)

DSRT DD CPS detection device for current and light detection (DSRT PS point sensors) including output for directly connecting two DSRT QD short-circuiter units.

NEW



Type DSRT ...	DD CPS BACA	DD CPS AACA
Part No.	782 030 ^{NEW}	782 031 ^{NEW}
Preis / pc(s)	0,00 €	0,00 €
Min. / max. voltage (U _N)	18-72 V d.c.	80-265 V a.c.
Degree of protection (front side)	IP 50	IP 50
Degree of protection (rear side)	IP 20	IP 20
Dimensions of the front plate (H x W)	177 x 102 mm	177 x 102 mm
Mounting dimensions (H x W x D)	157 x 82 x 177 mm	157 x 82 x 177 mm
Sensor inputs	S1, S2, S3, S4 (3 sensors (DSRT PS) can be connected per channel)	S1, S2, S3, S4 (3 sensors (DSRT PS) can be connected per channel)
Current inputs	1 A / 5 A (IL1, IL2, IL3, I _o)	1 A / 5 A (IL1, IL2, IL3, I _o)
Binary inputs	24 V d.c., 3 mA (B11, B12)	24 V d.c., 3 mA (B11, B12)
Tripping relay	Up to 250 V a.c./d.c. 5 A (T1, T2, T3, T4)	Up to 250 V a.c./d.c. 5 A (T1, T2, T3, T4)
High-speed outputs	Up to 250 V a.c./d.c. 2 A (HS01, HS02)	Up to 250 V a.c./d.c. 2 A (HS01, HS02)
Short-circuiter outputs	Optical fibre cable (at least 43 mA) (2x TX)	Optical fibre cable (at least 43 mA) (2x TX)
Binary output	24 V d.c. 20 mA (B01)	24 V d.c. 20 mA (B01)
Operating temperature range (T _U)	-35 °C ... +70 °C	-35 °C ... +70 °C
Tripping time of the relay	7 ms	7 ms
Tripping time HSO	< 2 ms	< 2 ms
Tripping time TX	< 2 ms	< 2 ms
Tripping time until short-circuit	< 5 ms with DSRT QD	< 5 ms with DSRT QD

Detection Device (Point Sensor)

DSRT DD PS detection device for light detection (DSRT PS point sensors) including output for directly connecting two DSRT QD short-circuiter units.

NEW



Type DSRT ...	DD PS BACA	DD PS AACA
Part No.	782 040 ^{NEW}	782 041 ^{NEW}
Min. / max. voltage (U _N)	18-72 V d.c.	80-265 V a.c.
Degree of protection (front side)	IP 50	IP 50
Degree of protection (rear side)	IP 20	IP 20
Dimensions of the front plate (H x W)	177 x 52 mm	177 x 52 mm
Mounting dimensions (H x W x D)	157 x 45 x 177 mm	157 x 45 x 177 mm
Sensor inputs	S1, S2, S3, S4 (3 sensors (DSRT PS) can be connected per channel)	S1, S2, S3, S4 (3 sensors (DSRT PS) can be connected per channel)
Binary inputs	24 V d.c., 3 mA (B11, B12)	24 V d.c., 3 mA (B11, B12)
Tripping relay	Up to 250 V a.c./d.c. 5 A (T1, T2, T3, T4)	Up to 250 V a.c./d.c. 5 A (T1, T2, T3, T4)
Short-circuiter outputs	Optical fibre cable (at least 43 mA) (2x TX)	Optical fibre cable (at least 43 mA) (2x TX)
Binary output	24 V d.c. 20 mA (B01)	24 V d.c. 20 mA (B01)
Operating temperature range (T _U)	-35 °C ... +70 °C	-35 °C ... +70 °C
Tripping time of the relay	7 ms	7 ms
Tripping time TX	< 2 ms	< 2 ms
Tripping time until short-circuit	< 5 ms with DSRT QD	< 5 ms with DSRT QD

Detection Device (Loop)

DSRT DD FS detection device for light detection (DSRT FS fibre optic sensor).

NEW



Type DSRT ...	DD FS BAAA	DD FS AAAA
Part No.	782 050 ^{NEW}	782 051 ^{NEW}
Min. / max. voltage (U _N)	18-72 V d.c.	80-265 V a.c.
Degree of protection (front side)	IP 50	IP 50
Degree of protection (rear side)	IP 20	IP 20
Dimensions of the front plate (H x W)	177 x 52 mm	177 x 52 mm
Mounting dimensions (H x W x D)	157 x 45 x 177 mm	157 x 45 x 177 mm
Sensor inputs	S1, S2, S3 (one fibre optic sensor (DSRT FS) can be connected per channel)	S1, S2, S3 (fibre optic sensor (DSRT FS) can be connected per channel)
Binary inputs	24 V d.c., 3 mA (B11, B12)	24 V d.c., 3 mA (B11, B12)
Tripping relay	Up to 250 V a.c./d.c. 5 A (T1, T2, T3, T4)	Up to 250 V a.c./d.c. 5 A (T1, T2, T3, T4)
Binary output	24 V d.c. 20 mA (B01)	24 V d.c. 20 mA (B01)
Operating temperature range (T _U)	-35 °C ... +70 °C	-35 °C ... +70 °C
Tripping time of the relay	7 ms	7 ms
Tripping time until short-circuit	< 5 ms with DSRT QD	< 5 ms with DSRT QD

Active Arc Fault Protection

Point Sensor

DSRT PS point sensor for arc detection. Serial connection of max. 3 sensors at each sensor input of DSRT DD CPS and DSRT DD PS devices.

Type DSRT ...	PS
Part No.	782 060 ^{NEW}
Dimensions (L x W x H)	90 x 32.8 x 19.5 mm
Fixing holes	2x 3.2 mm
Arc current threshold (I_{parc})	5 kA
Detection radius	90° (180°)
Arc current distance	max. 2 m (0.5 m)
Sensor wiring	Two cores and shielding
Sensor cable specification	Twisted pair, 0.75 mm ² , shielded
Max. sensor cable length per sensor cable	100 m
Degree of protection	IP 60
Operating temperature range (T_u)	-20 °C ... +85 °C

NEW



Fibre Optic Sensor

DSRT FS fibre optic sensor for arc detection. Connection of one sensor at each sensor input of DSRT DD FS devices.

General Information:	
Diameter	1.2 mm
Arc current threshold (I_{parc})	5 kA
Detection radius	360°

Type DSRT ...	FS 5	FS 10	FS 15
Part No.	782 075	782 080	782 090
Sensor length	5 m	10 m	15 m
Bending radius	10 mm	10 mm	10 mm
Arc current distance	max. 2 m	max. 2 m	max. 2 m
Operating temperature range (T_u)	-40 °C ... +85 °C	-40 °C ... +85 °C	-40 °C ... +85 °C

Type DSRT ...	FS 8 1.5	FS 10 1.5	FS 12 1.5	FS 15 1.5
Part No.	782 077 ^{NEW}	782 081 ^{NEW}	782 085 ^{NEW}	782 091 ^{NEW}
Sensor length	8 m	10 m	12 m	15 m
Bending radius	50 mm	50 mm	50 mm	50 mm
Arc current distance	max. 10 cm	max. 10 cm	max. 10 cm	max. 10 cm
Operating temperature range (T_u)	-5 °C ... +85 °C	-5 °C ... +85 °C	-5 °C ... +85 °C	-5 °C ... +85 °C

NEW



Accessories for Fixed Arc Fault Protection System DEHNshort

Foam Rubber

For fibre optic sensors DSRT FS.

Type	DSRT SR D8 L20
Part No.	782 098 ^{NEW}
Diameter	8 mm
Length	20 mm
PU	50 pc(s)

NEW



Fixing Clip

For fibre optic sensors DSRT FS.

Type	DSRT FC D8
Part No.	782 099 ^{NEW}
Diameter	8 mm
PU	50 pc(s)

NEW



Active Arc Fault Protection

Short-Circuiter

Short-circuiter unit for direct connection to DSRT DD CPS and DSRT DD PS detection devices or to external detection devices via the DSRT LWL U optic fibre converter.

NEW



Type DSRT ...	QD
Part No.	782 000 ^{NEW}
Min. / max. voltage (U _N)	400 V (-20% / +10%) 50 Hz
Dimensions (H x W x D)	107 x 168 + 20 x 180 mm
Prospective short-circuit current	5-80 kA (factor 2.2)
System configurations	TN, TT
Max. short-circuit time	50 ms (at 80 kA), 70 ms (at 50 kA)
Degree of protection	IP 00

Fibre Optic Cable

Prewired fibre optic cables for connecting DSRT DD CPS, DSRT DD PS detection devices and DSRT QD short-circuiter units or DSRT LWL U fibre optic converters and DSRT QD short-circuiter units.

1 set = 2 pieces

NEW



Type DSRT ...	LWL 0.75	LWL 2.00	LWL 4.00	LWL 8.00
Part No.	782 020 ^{NEW}	782 022 ^{NEW}	782 024 ^{NEW}	782 028 ^{NEW}
Length	0.75 m	2 m	4 m	8 m
Diameter	2.2 mm	2.2 mm	2.2 mm	2.2 mm

Fibre Optic Converter

DSRT LWL U fibre optic converter for use as interface converter (copper cable / fibre optic cable) between detection devices from other manufacturers and DSRT QD short-circuiter units.

NEW



Type DSRT ...	LWL U
Part No.	782 010 ^{NEW}
Supply voltage	24 V DC +/-20% (SELV)
Degree of protection	IP 20
Operating temperature range (T _U)	-5 °C ... +55 °C

Active Arc Fault Protection

Mobile Arc Fault Protection System DEHNarc

- Reliable arc fault detection
- Protection of persons in case of arc faults
- High availability of installations
- Mobile system can be quickly used in open switchgear installations

General Information:

Ambient temperature (during operation)	-10 °C ... +50 °C
Ambient temperature (storage)	-30 °C ... +70 °C
Nominal voltage	230 / 400 V / 50 Hz
Prospective short-circuit current	2-25 kA
Typical response time	5 ms (at 25 kA)

DEHNarc protects persons from the effects of an arc fault during live working.

It detects arc faults in an installation and immediately causes a short-circuit which trips the upstream overcurrent protective device. Consequently, the incident energy is considerably reduced. The protection system DEHNarc significantly limits the thermal effects of arc faults. BGI/GUV-I 5188 also refers to the mobile arc fault protection system to ensure personal protection. The mobile components (Figure 1)

- Control unit with three light sensors, mains and control line sockets
- Disconnecting blade
- Two short-circuiting cartridges
- Junction piece



Figure 1: Mobile components of the arc fault protection system.



Mobile arc fault protection system DEHNarc.

can be integrated in an open switchgear installation within a few seconds, removed after the work has been carried out and used again for the next installation. This increases flexibility and minimises investment costs.

The light sensor supports, NH fuse switch disconnector and the retaining device for the control unit are firmly fixed (Figure 2) to accept the control unit, sensors, short-circuiting cartridges, disconnecting blade and junction piece. The NH fuse block used for this purpose, which carries short-circuit currents up to 25 kA, can also be used during normal operation, for example as spare outgoing strip.



Figure 2: Fixed components for the mobile arc fault protection system.



Figure 3: Work on an open switchgear installation using a mobile arc fault protection system.

Active Arc Fault Protection



Control Unit

- Visual detection of an arc fault by means of three sensors and activation of the short-circuiting cartridges
- Visual and acoustic indication of the activation
- Self-testing element

Type DARC ...	STG
Part No.	781 000
Nominal voltage (U _N)	230 V
Overvoltage category	CAT II
Rated impulse withstand voltage	2.5 kV
Degree of protection	IP 20 (IP 30 in a connected state)
Enclosure dimensions (without sensors)	200 x 300 x 400 mm

Short-Circuiting Cartridge

- Short-circuiting cartridge with disconnecter cover for use in NH fuse switch disconnectors and for short-circuiting after receiving the signal of the control unit



Type DARC ...	KSP
Part No.	781 020
Nominal voltage (U _N)	230 / 400 V
Overvoltage category	CAT IV
Rated impulse withstand voltage	6 kV
Prospective short-circuit current	2-25 kA
Min. short-circuit time at 25 kA	70 ms (typically 100 ms)
Dynamic short-circuit strength	2.1 x 25 kA = 52.5 kA (peak value)
Size	NH 3
Degree of protection	IP 20 (IP 30 in an installed / connected state)

Disconnecting Blade

- Disconnecting blade with disconnecter cover for use in NH fuse switch disconnectors. Galvanic connection between the busbar and the control unit



Type DARC ...	TRM
Part No.	781 010
Nominal voltage (U _N)	230 / 400 V
Overvoltage category	CAT IV
Rated impulse withstand voltage	6 kV
Prospective short-circuit current	2-25 kA
Min. short-circuit time at 25 kA	70 ms (Type. 100 ms)
Dynamic short-circuit strength	2.1 x 25 kA = 52.5 kA (peak value)
Size	NH 3
Degree of protection	IP 20 (IP 30 in an installed / connected state)

Junction Piece

- Mounted in the NH fuse switch disconnector to ensure mechanical connection between the short-circuiting cartridges and the disconnecting blade



Type DARC ...	KST
Part No.	781 030
Tightening torque	32 Nm

Test Kit

- Test kit for testing the short-circuiting cartridges and the disconnecting blade for correct operation

Note: The disconnecting blades must be ordered separately.



Type DARC ...	PK KSP
Part No.	781 230
Nominal voltage (U _N)	230 V
Overvoltage category	CAT II
Rated impulse withstand voltage	2.5 kV
Degree of protection	IP 20 (IP 54 in a closed state)
Dimensions	550 x 420 x 300 mm

Active Arc Fault Protection

Light Sensor Spacer with plug-in Coupling

For use as intermediate element when mounting the two light sensors in the upper part of the low-voltage equipment cabinet.



Type DARC ...	LSDH
Part No.	781 100
Design	Plug-in coupling on both ends
Length	600 mm

Retaining Device for the Control Unit

The retaining device is connected to the DIN rail by means of the two plastic locking bolts.

Type DARC ...	HV STG
Part No.	781 110
Material	Plastic



Connecting Line Control Unit – Short-Circuiting Cartridge

Connecting line between the DARC STG control unit and the DARC KSP short-circuiting cartridge.

Type DARC ...	VL 4 1000	VL 4 1500
Part No.	781 130	781 150
Cable cross-section	4 mm ²	4 mm ²
Length	1000 mm	1500 mm
Pull-out force of the plug	At least 70 N	At least 70 N



Connecting Line Control Unit – Disconnecting Blade

Connecting line between the DARC STG control unit and the DARC TRM disconnecting blade.

Type DARC ...	VL 10 500	VL 10 1000
Part No.	781 170	781 190
Cable cross-section	10 mm ²	10 mm ²
Length	500 mm	1000 mm
Pull-out force of the plug	At least 70 N	At least 70 N



For more detailed information on the arc fault protection system DEHNarc, see installation instructions No. 1749.

Accessories for Mobile Arc Fault Protection System DEHNarc

Transport Case

For control unit, junction piece, connecting lines and light sensor spacers.
With wheels and foam padding.

Type	DARC TK
Part No.	781 220
Degree of protection	IP 54
Dimensions	800 x 520 x 400 mm
Colour	Black ●



Active Arc Fault Protection

Light Sensor Supports and Support Rails for DEHNarc



- The light sensor supports are designed for mounting the light sensors of the arc fault protection system DEHNarc
- There are two options for fixing the light sensor supports:
 - Wall mounting (2x 781 085, 1x 781 090)
 - Mounting on a support rail (2x 781 080, 1x 781 040, 1x 781 060, 1x 781 090)

Mounting the light sensors by means of the light sensor support rail of a switchgear installation



Light Sensor Support with Plug-in Coupling for wall mounting

To be mounted in the upper part of the low-voltage equipment cabinet on a vertical wall.

Type DARC ...	LSH WB
Part No.	781 085
Type	With four bolts and plastic dowel
Length	170 mm



Light Sensor Support with Coupling

To be mounted on the lower C-rail of the low-voltage equipment cabinet.

Type DARC ...	LSH SB
Part No.	781 090
Type	With M10 threaded pin and nut for C-rails
Length	157 mm



Light Sensor Support with Plug-in Coupling

To be mounted in the hole of the light sensor support rail.

Type DARC ...	LSH M10
Part No.	781 080
Type	With M10 threaded pin and nut
Length	136 mm

Light Sensor Support Rail, left

To be mounted to the DIN rail in the upper part of the low-voltage equipment cabinet by means of a knurled nut.



Type DARC ...	LSHS L 940
Part No.	781 040
Type	Angular rail
Length	940 mm



Light Sensor Support Rail, right

To be mounted to the DIN rail in the upper part of the low-voltage equipment cabinet by means of a knurled nut.

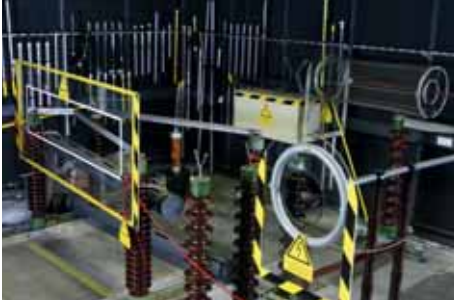

Type DARC ...	LSHS R 940
Part No.	781 060
Type	Angular rail
Length	940 mm

For more detailed information on the light sensor supports and retaining devices of the DEHNarc control unit, see installation instructions No. 1804.

Product	Application	Page
Periodic Tests for Safety Devices at DEHN + SÖHNE		
		Maintenance tests 144



One of our high-voltage laboratories.

Contact

DEHN + SÖHNE Standort 2
 Service-Center Retouren
 Am Ludwigskanal 1
 92360 Mühlhausen
 Germany
 E-Mail retoure@dehn.de

Maintenance Test

Only tested devices protect your life

- Regular maintenance tests ensure that your devices are in a good order and condition
- Maintenance tests in DEHN + SÖHNE's high-voltage test laboratory for operating and earthing sticks, voltage detectors, phase comparators, devices for voltage detecting systems, earthing and short-circuiting devices
- Test is documented on the device and in a separate test report

Voltage Detector Retest > 1 kV to IEC/EN 61243-1

Test Report No.: PHEC 005856 20131002



DETAILED INFORMATION ON THE UNIT

Voltage detector type: PHE III	Nominal voltage: 20KV	
Art.-No.: 767720	Man.-No.: 005856	Year of man.: 2007
Test prod type: 767761	Man.-No.: 007051	Year of man.: 2007
Insulating rod type: 766009	Man.-No.: 010168	Year of man.: 2007
Last retest made (accord. to type label):		
Notes: repeat examination		
Customer: John Doe 12345 Any City, Any Street 1		
Goods receipt No.: 37630	dated: 16.06.2013	

TEST IN ACCORDANCE WITH DIN VDE 0682 TEIL 411

1. Test by visual inspection a) Orderly State <input checked="" type="checkbox"/> yes <input type="checkbox"/> no b) Mechanical damage <input type="checkbox"/> yes <input checked="" type="checkbox"/> no c) Arcing or leakage current effects <input type="checkbox"/> yes <input checked="" type="checkbox"/> no d) Instructions for Use <input checked="" type="checkbox"/> yes <input type="checkbox"/> no e) Unit complete <input checked="" type="checkbox"/> yes <input type="checkbox"/> no f) Markings readable <input checked="" type="checkbox"/> yes <input type="checkbox"/> no g) Construction visible <input checked="" type="checkbox"/> yes <input type="checkbox"/> no h) Red ring visible and present <input checked="" type="checkbox"/> yes <input type="checkbox"/> no i) Hollow parts closed <input checked="" type="checkbox"/> yes <input type="checkbox"/> no k) Degree of protection of indicator given (visual inspection of enclosure sealings) <input checked="" type="checkbox"/> yes <input type="checkbox"/> no l) Active indication signals <input checked="" type="checkbox"/> yes <input type="checkbox"/> no m) Self-test unit ready for operation <input checked="" type="checkbox"/> yes <input type="checkbox"/> no		2. Test by handling a) Individual parts locked against unintentional loosening <input checked="" type="checkbox"/> yes <input type="checkbox"/> no b) Hand guard and red ring are solidly fitted <input checked="" type="checkbox"/> yes <input type="checkbox"/> no	
		3. Test by measurement a) Length of insulating piece as determined <input checked="" type="checkbox"/> yes <input type="checkbox"/> no b) Length of extension piece as determined <input checked="" type="checkbox"/> yes <input type="checkbox"/> no	
		4. Test on discharge current Discharge current below 0,2 mA <input checked="" type="checkbox"/> yes <input type="checkbox"/> no	
		5. Test on short-circuit withstand Short-circuits or disruptive discharges <input type="checkbox"/> yes <input checked="" type="checkbox"/> no	
		6. Test for clear indication a) Clear indication <input checked="" type="checkbox"/> yes <input type="checkbox"/> no b) Clear perceptibility of visual indication <input checked="" type="checkbox"/> yes <input type="checkbox"/> no c) Clear perceptibility of acoustic indication <input checked="" type="checkbox"/> yes <input type="checkbox"/> no	

ADDITIONAL NOTES

Report number PHEC 005856 20131002	The test was made with equipment, the measurement standards of which base on the standards of the Physical and Technical Federal Institute of Brunswick and Berlin (PTB) directly resp. indirectly via a German calibration facility.
9 Volt battery changed.	

ALL TESTED CHARACTERISTICS COMPLY WITH THE ABOVE MENTIONED STANDARD. THE MAINTENANCE TEST WAS PASSED SUCCESSFULLY AND WAS MARKED ON THE RATING PLATE: yes no



Marks: 2013 Next maintenance test: 2019

NEUMARKT, 07.10.2013 - Meier Robert Signature of Quality Management

Maintenance test criteria for protective and auxiliary equipment

	DGUV regulation 3 (former BGV A3)	VDE 0105-100	Equipment standard
Earthing and short-circuiting devices	§ 5 (1) [... It shall be checked whether equipment is in good order and condition...] (2) [... at certain intervals. The intervals must be chosen so that the defects to be expected are detected in due time.]	5.3.101 [Periodic inspections, general information.]	IEC/EN 61230, Annex C (informative), C 3.2.2 [It is recommended to perform a cut test and visual inspection at least every five years in case of outdoor use and every ten years in case of indoor use.]
Voltage detectors, phase comparators and voltage detecting systems	§ 5: according to table 1C [Tests for compliance with the limit values specified in the electrotechnical rules must be carried out at least every six years.]	6.2.3 [Inspection at least before and, if possible, after each use], 5.3.101 [Periodic inspections, general information.]	IEC/EN 61243-1, Annex G (informative): Tests for capacitive voltage detectors > 1 kV [Voltage detectors that have not been subjected to a maintenance test within six years should not be used.] IEC/EN 61243-5: Tests for voltage detecting systems (VDS) IEC/EN 61481, Annex G (informative): Tests for phase comparators between 1 and 36 kV a.c. [The maximum interval between maintenance tests is six years.]
Operating and earthing sticks	§ 5: according to table 1C [A visual inspection for signs of damage and defects must be carried out prior to each use.]	5.3.101 [Periodic inspections, general information.]	VDE 0681-1 to 3: Tests for operating sticks Note: Operating sticks also have to be subjected to electrotechnical tests. DEHN + SÖHNE recommends to use the test intervals of voltage detectors. E DIN VDE V 0681-1 to 3 Annex B (informative) [Maximum interval between maintenance tests for operating sticks is six years.]

Part No.	Item
Periodic Testing of ...	
799 971	Passive voltage detector for nominal voltages up to 30 kV (all brands) *
799 950	Voltage detector for nominal voltages up to 30 kV (all brands) *
799 951	Voltage detector for nominal voltages exceeding 30 kV [up to 132 kV / 50 Hz] (all brands) *
799 952	Voltage detector for overhead contact lines for nominal voltages up to 15 kV (all brands) *
799 953	Voltage detector for voltage ranges up to 30 kV (all brands) *
799 954	Voltage detector for voltage ranges exceeding 30 kV [up to 132 kV / 50 Hz] (all brands) *
799 955	Voltage detector for voltage ranges up to 30 kV – switchable / standby / test kit (all brands) *
799 956	Voltage detector for voltage ranges exceeding 30 kV [up to 132 kV / 50 Hz] – switchable / standby (all brands) *
799 957	Distance voltage detector (D+S devices only)
799 958	Capacitive voltage detecting system (all brands) <i>Note: Passive voltage indicators are not tested!</i>
799 959	Two-pole resistive phase comparator up to 36 kV (D+S devices only) **
799 960	Single-pole capacitive phase comparator up to 36 kV (D+S devices only) *
799 961	Single-pole capacitive phase comparator (switchable) up to 36 kV (D+S devices only) *
799 962	Resistive d.c. voltage detector with one stick (D+S devices only)
799 963	Resistive d.c. voltage detector with two sticks (D+S devices only)
799 964	Operating stick [fuse tong, insulating stick, switching stick and rescue rod] (all brands)
799 965	Operating stick kit (all brands)
799 966	Additional test prod for voltage detectors and two-pole phase comparators
799 967	Test probe
Periodic Testing (visual and technical) of ...	
799 990	Single-pole earthing and short-circuiting device
799 991	Three-pole earthing and short-circuiting device
Technical Testing of ...	
799 992	Earthing stick (all brands)
799 993	Test adapter / measuring impedance for capacitive voltage detecting system (all brands)

* including one test prod / ** including two test prods









A large grid of graph paper for taking notes, consisting of 20 columns and 30 rows of small squares.



DEHN protects.

Further Equipment

Product	Type	Application	Page
Measuring Device			
	MikroΩmeter	Mobile measuring system for performing technical tests on portable earthing and short-circuiting devices at regular intervals	150
SDS Voltage Limiting Devices			
	SDS	Voltage limiting devices	151
Barriers			
		Barriers	155
Discharge Devices			
		For discharging static charges Different contact electrodes	157
Storage Bags and Transport Cases			
		Easy Choice	160
		Cases: Sheet steel or plastic Bags: Artificial leather or canvas	161
Accessories, Spare Parts and Kit Parts			
		Accessories	166
		Spare parts	171
		Kit parts	172
Index			
		Index of Part Nos.	181
		Index of Variant Nos.	187
		Index of Types	188
		Key words	192

MikroΩmeter LoRe EaS

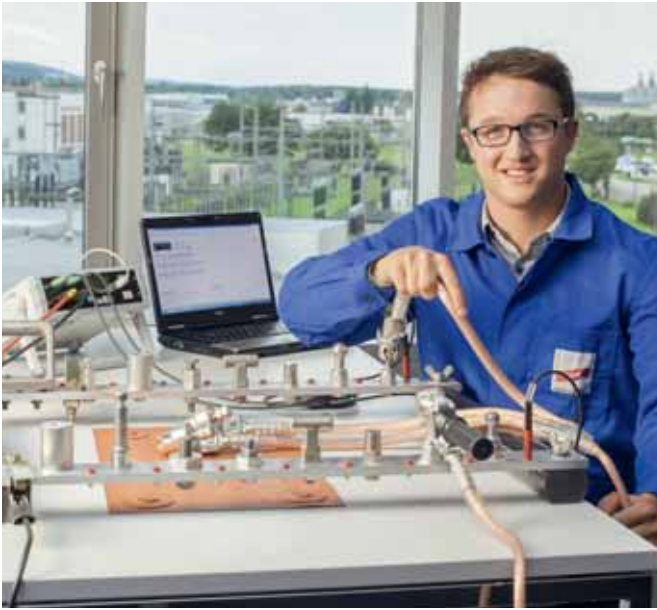

MikroΩmeter

- Mobile measuring system for performing technical tests on portable earthing and short-circuiting devices (EaS) at regular intervals
- For determining minimum ohmic resistances of earthing and short-circuiting devices and the quality of electrical connections e.g. in case of conductor rails or switch contacts
- Electronic transfer of measured values to the evaluation software via USB interface
- Software-aided procedure and automatic documentation of results
- Acoustic signal as soon as the limit values are exceeded
- Calibrated when delivered
- Software update via USB interface

NEW



Type	MOMS LORE EUK
Part No.	799 100 <small>NEW</small>
Measuring range	0.01 μΩ ... 500 mΩ
Min. resolution	1 nΩ
Measuring accuracy	10 nΩ
Type of measurement	Four-conductor measurement
Measuring current	Approx. 30 A ... 70 A
Interface	USB 2.0 connection
Dimensions (case) (H x W x D)	190 x 500 x 450 mm
Weight (with accessories)	Approx. 9 kg
Temperature range	-10 °C ... +40 °C



Voltage Limiting Device

- Electrical isolation of insulated track sections and earthed parts of installations
- Safe equipotential bonding in case of a short-circuit or earth fault at the overhead contact line due to high-current-resistant welding of the electrodes
- Discharge of lightning surges without short-circuit formation due to lightning-resistant SDS ... voltage limiting device
- Short-circuit withstand capability up to 25 kA_{rms} / 100 ms; 36 kA_{rms} / 75 ms



EN 50122-1 describes the use of voltage limiting devices for d.c. and a.c. traction systems for so-called "open traction system earthing" of conductive components of the overhead contact line and pantograph zone. Voltage limiting devices (SDS ...) are used to prevent the occurrence of hazardous surges between the insulated tracks or track sections of electric railways and earthed parts of the installation.

Their function is to permanently connect parts of the installation in the overhead contact line and pantograph zone to the return circuit as soon as the threshold voltage is exceeded.

In case of atmospheric overvoltages, the lightning-resistant SDS ... voltage limiting device is capable of returning to its initial state after discharging the impulse current. Only if the specified lightning current load is exceeded, a permanent short-circuit is initiated by high-current-resistant welding of the electrodes and the fuse link has to be replaced.

The SDS voltage limiting device consists of a spark gap unit and the respective connecting kit and can be directly connected to the rail or overhead contact line tower.

The spark gap unit of type SDS 1 (Part No. 923 110) developed by DEHN + SÖHNE has also been approved by the German Federal Railway Authority (EBA).

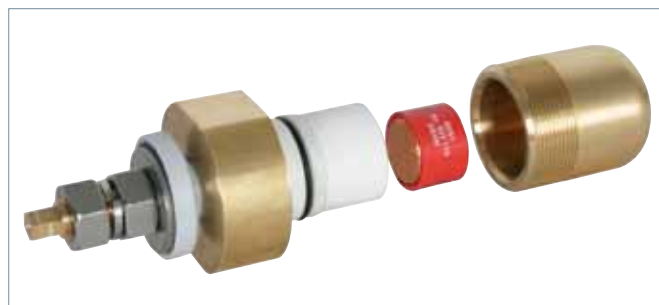

SDS 1

Voltage limiting device for a power-frequency sparkover voltage ≤ 950 V.



Type SDS ...	1
Part No.	923 110
Power frequency sparkover voltage (U_{aw})	≤ 950 V
d.c. sparkover voltage (U_{ag})	570 ... 780 V
Impulse sparkover voltage	≤ 1200 V (1 kV/ μ s)
Self-extinguishing capability	300 A / 65 V
Lightning current discharge capacity (10/350 μ s) 0.1x / 0.5x / 1x	5 kA
Lightning current withstand capability (10/350 μ s)	25 kA
Safe short-circuit due to welding of the electrodes in case of alternating currents	≥ 2.5 kA / 1000 V / 30 ms, ≥ 1.5 kA / 1000 V / 100 ms
Safe short-circuit due to welding of the electrodes in case of direct currents	≥ 750 A / 250 ms
Short-circuit withstand capability	25 kA _{rms} / 100 ms; 36 kA _{rms} / 75 ms
Long-term current	1 kA _{rms} for $t \leq 120$ s
Leakage current (I_{lc})	< 1 μ A for 100 V d.c.
Operating temperature range (T_U)	-40 °C ... +80 °C
To be mounted with	MA SDS M12 mast adapter
Approvals	EBA
DB drawing No.	4 Ebs 15.13.20 Sheet 2

SDS 2

Voltage limiting device for a d.c. sparkover voltage of 350 V.



Type SDS ...	2
Part No.	923 117
d.c. sparkover voltage (U_{ag})	350 V +/- 20 %
Impulse sparkover voltage	≤ 900 V (1 kV/ μ s)
Lightning current discharge capacity (10/350 μ s) 0.1x / 0.5x / 1x	2 kA
Lightning current withstand capability (10/350 μ s)	25 kA
Safe short-circuit due to welding of the electrodes in case of direct currents	≥ 600 A / 250 ms
Short-circuit withstand capability	25 kA _{rms} / 100 ms; 36 kA _{rms} / 75 ms
Long-term current	1 kA _{rms} for $t \leq 120$ s
Leakage current (I_{lc})	< 1 μ A for 100 V d.c.
Operating temperature range (T_U)	-40 °C ... +80 °C
To be mounted with	MA SDS M12 mast adapter

SDS 3

Voltage limiting device for a d.c. sparkover voltage of 550 V.



Type SDS ...	3
Part No.	923 116
d.c. sparkover voltage (U_{ag})	550 V
Impulse sparkover voltage	≤ 1000 V (1 kV/ μ s)
Lightning current discharge capacity (10/350 μ s) 0.1x / 0.5x / 1x	2.5 kA
Lightning current withstand capability (10/350 μ s)	25 kA
Short-circuit withstand capability	25 kA _{rms} / 100 ms
Operating temperature range (T_U)	-40 °C ... +80 °C
To be mounted with	MA SDS M12 mast adapter

SDS 4

Voltage limiting device for a d.c. sparkover voltage of 230 V.

Type SDS ...	4
Part No.	923 118
d.c. sparkover voltage (U_{ag})	230 V +/- 20%
Impulse sparkover voltage	≤ 650 V (1 kV/μs)
Lightning current discharge capacity (10/350 μs) 0.1x / 0.5x / 1x	2.5 kA
Lightning current withstand capability (10/350 μs)	25 kA
Impulse current discharge capacity (8/20 μs) 0.1x / 0.5x / 1x	20 kA
Safe short-circuit due to welding of the electrodes in case of direct currents	≥ 600 A / 250 ms
Short-circuit withstand capability	25 kA _{rms} / 100 ms; 36 kA _{rms} / 75 ms
Long-term current	1 kA _{rms} for t ≤ 120 s
Leakage current (I_{lc})	< 1 μA for 100 V d.c.
Operating temperature range (T_U)	-40 °C ... +80 °C
To be mounted with	MA SDS M12 mast adapter



SDS 5

Voltage limiting device for a d.c. sparkover voltage of 120 V.

Type SDS ...	5
Part No.	923 119
d.c. sparkover voltage (U_{ag})	120 V +/- 20 %
Impulse sparkover voltage	≤ 600 V (1 kV/μs)
Lightning current discharge capacity (10/350 μs) 0.1x / 0.5x / 1x	2 kA
Lightning current withstand capability (10/350 μs)	25 kA
Impulse current discharge capacity (8/20 μs) 0.1x / 0.5x / 1x	20 kA
Safe short-circuit due to welding of the electrodes in case of direct currents	≥ 600 A / 250 ms
Short-circuit withstand capability	25 kA _{rms} / 100 ms; 36 kA _{rms} / 75 ms
Long-term current	1 kA _{rms} for t ≤ 120 s
Leakage current (I_{lc})	< 1 μA for 100 V d.c.
Operating temperature range (T_U)	-40 °C ... +80 °C
To be mounted with	MA SDS M12 mast adapter



Accessories for Voltage Limiting Devices

Mast Adapter for SDS Voltage Limiting Devices

For installation on the mast profile of overhead contact line masts with Ø8-12 mm.

Type	MA SDS M12
Part No.	723 199
Lightning current carrying capability (10/350 μs)	25 kA
Short-circuit withstand capability	21 kA _{rms} / 30 ms
Long-term current	1 kA _{rms} at t ≤ 120 s
Leakage current (I_{lc})	< 1 μA at 100 V d.c.
Dimensions of the threaded pin	M12
Material	Brass
Degree of protection of the inner enclosure	IP 67



DEHN protects.



Barrier and Accessories

- Barrier and accessories for providing protection for parts of an installation



Barrier in a transformer station.

Barrier

Robust design, suitable for indoor and outdoor installations

Type	AB 32 46 RW K L...
Part No.	700 099
Material	Glass-fibre reinforced polyester
Dimensions (W x H)	32 x 46 mm
Length	Any up to 6000 mm *)
Colour	Red ● / Withe ○



*) Length to be specified when ordering!

Barrier Holder

1 set = 2 pieces

Type	H AB 32 46 K
Part No.	700 098
Material	Plastic
Colour	Red ●





DEHN protects.

Single-pole Earthing and Discharge Devices

- For discharging static charges
- Different contact electrodes
- Coupling electrode, especially for round conductors (Ø12 ... 26.5 mm) of electrostatic precipitator systems
- Waterproof, plastic-sheathed cable entries, with additional anti-kink protection



General Information:	
Use	Not suitable for use in wet weather conditions
Material (contact electrode)	Cu alloy/gal Sn
Material (contact and coupling electrode)	Zamak
Material (coupling electrode)	Bronze/gal Sn
Material (insulating tube)	Glass-fibre reinforced polyester tube
Material (earthing cable)	Cu, highly flexible



Single-pole device for discharging static charges

Discharge Device with Handle and Earth Clamp with Wing Bolt

Type EV ...	TES 465 EK
Part No.	758 020
Cable length	3500 mm
Cable cross-section	16 mm ²
Cable sheath	Transparent
Total length (l _G)	550 mm
Clamping range	Up to 20 mm

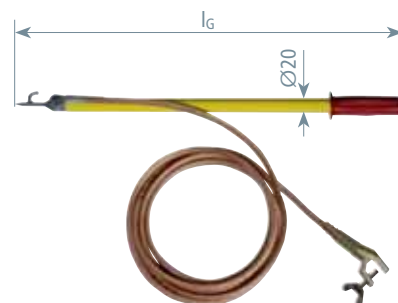

Discharge Device with Handle and Spring-loaded Earth Pliers

Type EV ...	TES 465 EZ
Part No.	758 021
Cable length	3500 mm
Cable cross-section	16 mm ²
Cable sheath	Transparent
Total length (l _G)	550 mm
Clamping range	Up to 18 mm

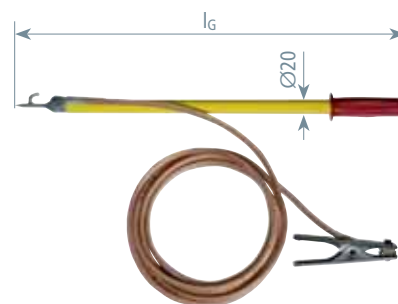

Discharge Device with Handle and Cable Lug at the Earth Cable End

Hole (Ø8.4 mm) and silicone cable

Type EV ...	TES 465 KS10
Part No.	758 022
Cable length	3500 mm
Cable cross-section	10 mm ²
Cable sheath	Red silicone cable
Total length (l _G)	550 mm

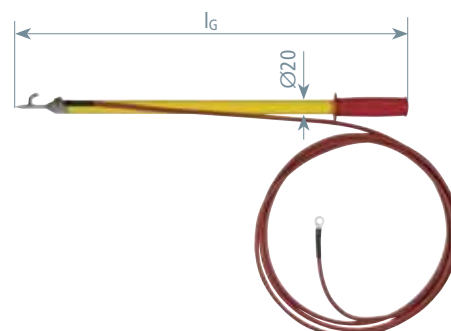

Discharge Device with Earth Clamp with Wing Bolt

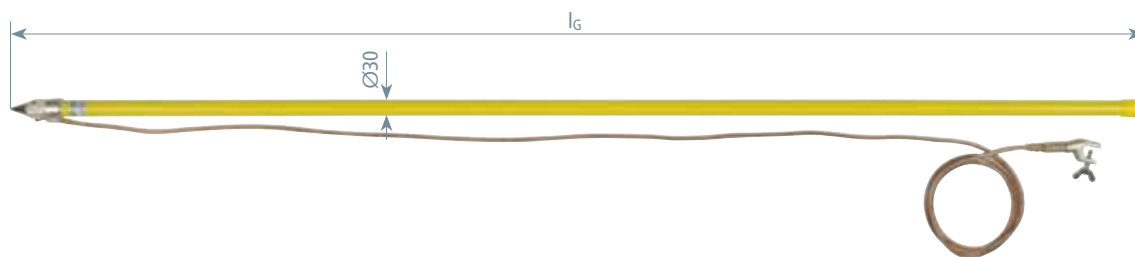

Type EV ...	TS 2000 EK
Part No.	758 001
Cable length	3500 mm
Cable cross-section	16 mm ²
Cable sheath	Transparent
Total length (l _G)	2050 mm
Clamping range	Up to 20 mm

Discharge Device with Spring-loaded Earth Pliers

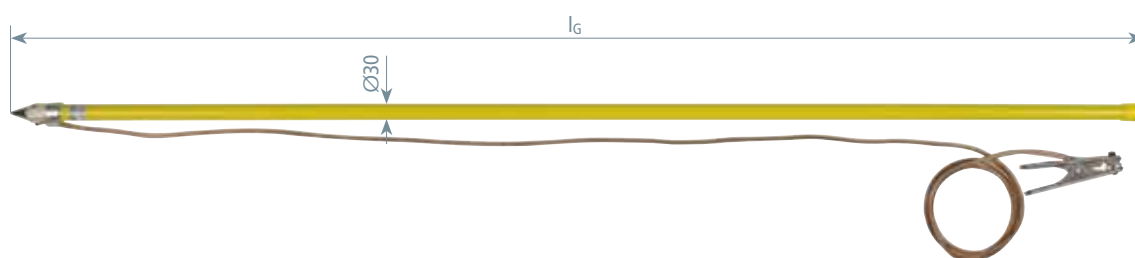

Type EV ...	TS 2000 EZ
Part No.	758 003
Cable length	3500 mm
Cable cross-section	16 mm ²
Cable sheath	Transparent
Total length (l _G)	2050 mm
Clamping range	Up to 18 mm

Earthing Device with Earth Clamp with Tommy Bar

For round conductors (Ø12 ... 26.5 mm) of electrostatic precipitator systems

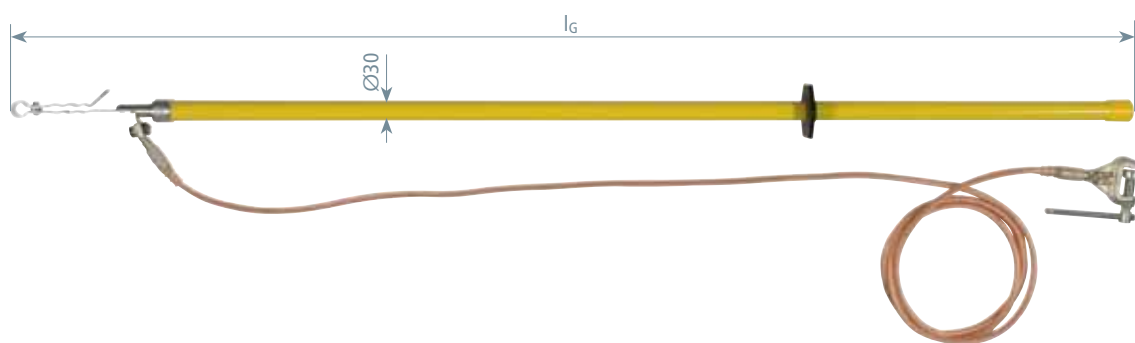

Type EV ...	EH 1725 EK
Part No.	758 015
Cable length	3500 mm
Cable cross-section	25 mm ²
Cable sheath	Transparent
Total length (l _G)	1725 mm
Clamping range	Up to 30 mm

Discharge Device with Contact and Coupling Electrode and Cable Lug at the Earth Cable End

PK1 anti-rotation crimped cable lug (hole $\varnothing 12.5$ mm).

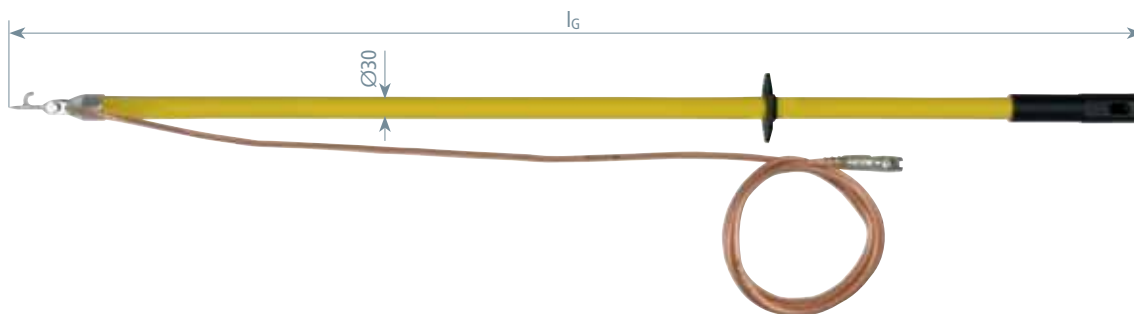

Type EV ...	TES STK 1500 KS
Part No.	758 025
Cable length	3500 mm
Cable cross-section	16 mm ²
Cable sheath	Transparent
Total length (l _G)	1500 mm

Discharge Device with Contact Electrode and Cable Lug at the Earth Cable End

PK1 anti-rotation crimped cable lug (hole $\varnothing 12.5$ mm).

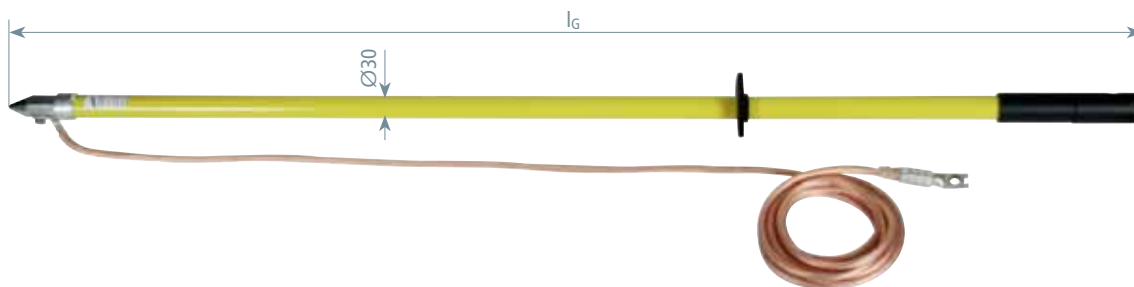

Type EV ...	TS 1470 SN7685
Part No.	758 031
Cable length	5000 mm
Cable cross-section	16 mm ²
Cable sheath	Transparent
Total length (l _G)	1500 mm

Discharge Device with Clamp and Cable Lug at the Earth Cable End

PK1 anti-rotation crimped cable lug (hole $\varnothing 12.5$ mm).

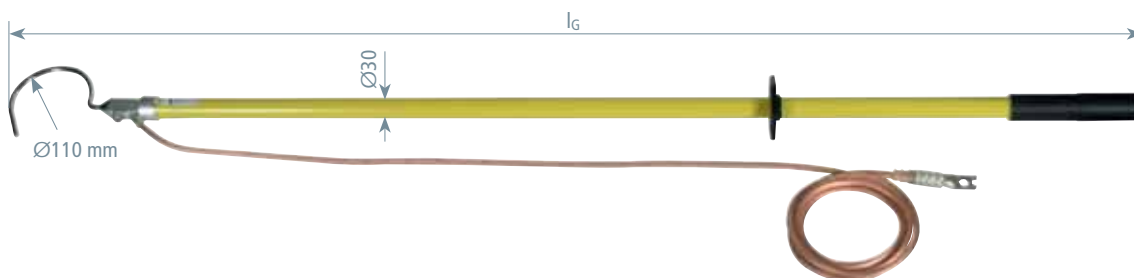

Type EV ...	EHB 1600 SN7114
Part No.	758 028
Cable length	3500 mm
Cable cross-section	16 mm ²
Cable sheath	Transparent
Total length (l _G)	1600 mm

Storage Bags and Transport Cases

Sheet Steel Case

- For voltage detectors, phase comparators and earthing and short-circuiting devices VI/TI.

Sheet Steel Case for PHE III

Hammer-tone finished with foam padding.

Type	SKL 95 21 10
Part No.	767 701
Dimensions	950 x 210 x 115 mm
Colour	Blue ●



Sheet Steel Case for PHE

Hammer-tone finished with retaining springs.

Type	SKL 92 16 10	SKL 116 16 10
Part No.	766 703	766 603
Dimensions	920 x 160 x 115 mm	1150 x 160 x 115 mm
Colour	Blue ●	Blue ●

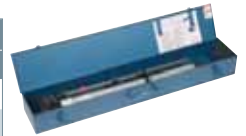

Sheet Steel Case for PHV

Hammer-tone finished with foam padding.

Type	SKL 95 21 10 V2
Part No.	759 003
Dimensions	950 x 210 x 115 mm
Colour	Blue ●

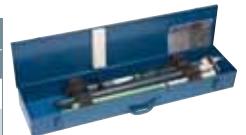

Sheet Steel Case for Earthing and Short-Circuiting Device VI/TI

Optionally available with foam padding.

Type	SBKL EKS VI KVS	SBKL EKS TI KVS 2F	SBKL EKS TI KVS
Part No.	745 900	766 298	766 300
Dimensions	440 x 330 x 100 mm	440 x 330 x 66 mm	380 x 260 x 80 mm
Colour	Blue ●	Blue ●	Blue ●
Design	With foam padding	With foam padding	—



Plastic Case

- For voltage detectors, phase comparators, voltage detecting systems and earthing and short-circuiting devices.

Universal Plastic Case

With aluminium frame and convoluted foam.

Type	KKL 92 28 12	KKL 127 28 12
Part No.	766 994 ^{NEW!}	766 995 ^{NEW!}
Dimensions	920 x 280 x 126 mm	1270 x 280 x 126 mm
Colour	Black ●	Black ●



Plastic Case for PHE III

With foam padding.

Type	KKL PHE3	KKL PHE3 L
Part No.	767 997	767 999
Dimensions	940 x 235 x 140 mm	1290 x 235 x 140 mm
Colour	Black ●	Black ●





Plastic Case for PHE III Indicator with Test Prod

With foam padding

Type	KKL PK PHE3 L
Part No.	766 036
Dimensions	390 x 280 x 80 mm
Colour	Grey ●

Plastic Case for PHE III – Kit

With foam padding



Type	KKL PHE3 60 110
Part No.	766 998
Dimensions	1290 x 235 x 140 mm
Colour	Black ●

Plastic Case for PHE

With foam padding



Type	KKL PHE	KKL PHE L
Part No.	766 997	766 999
Dimensions	940 x 235 x 140 mm	1290 x 235 x 140 mm
Colour	Black ●	Black ●

Plastic Case for PHV

With foam padding



Type	KKL PHV	KKL PHV1
Part No.	759 999	759 998
Dimensions	940 x 235 x 140 mm	1290 x 235 x 140 mm
Colour	Black ●	Black ●

Plastic Case for DEHNcap

With foam padding



Type	KKL DCA	KKL 26 22 5
Part No.	767 107	767 106
Dimensions	390 x 280 x 84 mm	265 x 215 x 50 mm
Colour	Grey ●	Black ●

Plastic Case for Earthing and Short-Circuiting Device VI/TI

With foam padding



Type	KK 56 41 17 EK VI TI	KKL EKS VI KVS
Part No.	745 952	745 902
Dimensions	565 x 410 x 170 mm	450 x 350 x 110 mm
Colour	Black ●	Black ●

Plastic Case for Earthing and Short-Circuiting Devices

With retaining springs for two-part earthing stick.



Type	KK 56 41 17 EK HK
Part No.	745 953
Dimensions	565 x 410 x 170 mm
Colour	Black ●

Artificial Leather Bag

- For voltage detectors, phase comparators and insulating sticks.

Artificial Leather Bag for PHE III, PHE, ASP, PHV, PHV I and IS STK

With zip, carrier handle and shoulder strap.

Type KLT ...	101 30 10	133 34 10
Part No.	767 996	766 996
Dimensions	1010 x 300 x 100 mm	1300 x 345 x 100 mm
Colour	Black ●	Black ●



Artificial Leather Bag for PHE

With carrier handle

Type KLT ...	247 10 22
Part No.	766 602
Dimensions	2470 x 220 x 100 mm
Colour	Black ●



Artificial Leather Bag for PHE and PHV I

With carrier handle

Type KLT ...	121 25 16
Part No.	766 601
Dimensions	1200 x 250 x 160 mm
Colour	Black ●



Artificial Leather Bag for PHE/G

With carrier handle

Type KLT ...	160 17
Part No.	766 614
Dimensions	Ø170 x 1600 mm
Colour	Black ●



Artificial Leather Bag for ASP and HSA

With carrier handle.

Type KLT ...	104 9
Part No.	767 574
Dimensions	Ø90 x 1040 mm
Colour	Black ●



Canvas Bag

- For voltage detectors, insulating sticks and earthing and short-circuiting devices

Canvas Bag for PHE

With carrier handle.



Type STT ...	120 30 15
Part No.	766 704
Dimensions	1220 x 390 x 150 mm
Colour	Olive ●

Canvas Bag for ISMTC

With carrier handle.



Type STT ...	180 20
Part No.	766 039
Dimensions	Ø200 x 1800 mm
Colour	Olive ●

Canvas Bag for six-part Earthing Stick

With carrier handle.



Type STT ...	110 15
Part No.	769 509
Dimensions	Ø150 x 1100 mm
Colour	Olive ●
DB drawing No.	3 Ebgw 01.67

Canvas Bag for Earthing and Short-Circuiting Device

With two separate internal pockets and carrier handle.



Type STT ...	55 27 30
Part No.	785 111
Dimensions	550 x 255 x 300 mm
Colour	Olive ●
DB drawing No.	3 Ebgw 01.67

Plastic Bag / Rucksack

- For DEHNcare protective equipment.

Storage Bag

With side handle, carrying strap and string.



Type	AT 50 30
Part No.	785 442
Suitable for	ESH U + DEHNcare APS and APG
Dimensions	Ø300, 500 mm
Colour	Red ●













Storage Rucksack

With carrying straps and side net pocket with string.



Type	ARS 65 40
Part No.	785 443
Suitable for	DEHNcare protective equipment
Dimensions	650 x 400 mm
Colour	Red ●

Accessories, Spare Parts, Kit Parts

Product	Application	Page
Accessories – Electrodes, Probes		
	Electrodes with M8 thread, to be screwed on test prods	166
	Probes with M8 thread, to be screwed on test electrodes For switchgear installations with limited access	167
Accessories – Adapters and End Fittings		
	With plug-in coupling	168
Accessories – Storage Devices, Installation Devices		
	Storage devices for earthing and short-circuiting devices, sticks and fuse tongs	169
	Installation devices for fixed ball and earthing points	170
Spare Parts		
		171
Kit Parts – Test Prods, Indicators, Field Sensor, Operating Heads		
	Test prods for safe contact with parts of an installation to be tested	172
	Indicators / Indicator with Test Prod	173
	Field Sensor	174
	Operating Heads	174
Kit Parts – Insulating Sticks, Insulating Elements, Handle / Extensions, Adapters		
	Insulating Sticks	176
	Insulating Elements	178
	Handle / Extensions	179
	Adapters	180

Electrodes

- Safe contact with the part of an installation to be tested
- With M8 thread, to be screwed on the test prods of PHE III and PHE voltage detectors as well as PHV phase comparators

Onion-shaped Electrode

For contacting varnished busbars.



Type EL M8 ...	SZ PHE PHV
Part No.	766 913
Nominal voltage (U _N)	From 3 kV
Material	Brass/gal CuSn

Pin-shaped Electrode

For contacting varnished busbars.



Type EL M8 ...	S PHE PHV
Part No.	766 925
Nominal voltage (U _N)	From 3 kV
Material	StSt

V-shaped Electrode

For contacting round conductors.



Type EL M8 ...	V PHE PHV
Part No.	766 927
Nominal voltage (U _N)	From 3 kV
Material	Cu/gal Sn

Hook-shaped Electrode

For contacting overhead line conductors.



Type EL M8 ...	H PHE
Part No.	766 923
Application	For overhead lines only
Material	St/gal Zn

Fork-shaped Electrode

For contacting overhead line conductors.



Type EL M8 ...	G PHE
Part No.	766 924
Application	For overhead lines only
Material	StSt

Eaton Holec Magnefix Electrode

For Eaton Holec Magnefix switchgear installations of type MA, MD4, MF, MG, MY.



Type EL M8 ...	MAG PHE PHV
Part No.	766 915
Nominal voltage (U _N)	3 ... 15 kV
Material	Brass/gal CuSn, PVC

Test Probes

- Safe contact with the part of an installation to be tested
- With M8 thread, to be screwed on test electrodes of PHE and PHE III voltage detectors
- For switchgear installations with limited access
- Available in different lengths and angles

Test Probe, straight

For switchgear installations with limited access (e.g. Calor Emag/Isopond and Krone/KES).

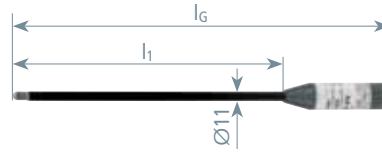

Type PSO M8 ...	PHE
Part No.	766 916
Nominal voltage (U _N)	3 ... 24 kV
Diameter	11 mm
Total length (l _G)	420 mm
Length (l ₁)	300 mm
Not suitable for use in wet weather conditions	☀



Test Probe, straight, 800 mm

For transformer stations and switchgear installations that require a greater insertion depth.

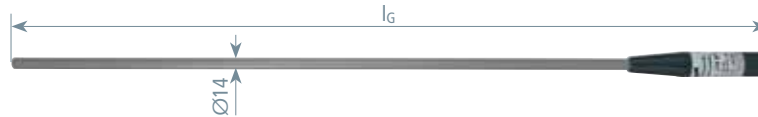

Type PSO M8 ...	PHE L800
Part No.	766 960
Nominal voltage (U _N)	3 ... 24 kV
Diameter	14 mm
Total length (l _G)	890 mm
For use in wet weather conditions	☁



Test Probe, 25° angled

For switchgear installations with limited access.

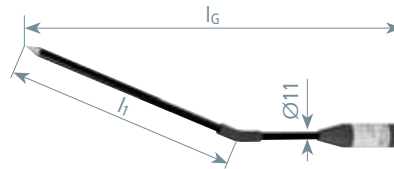

Type PSO M8 ...	W25 PHE
Part No.	766 940
Nominal voltage (U _N)	3 ... 24 kV
Diameter	11 mm
Total length (l _G)	450 mm
Length (l ₁)	280 mm
Not suitable for use in wet weather conditions	☀



Test Probe, 45° angled

For switchgear installations with limited access.

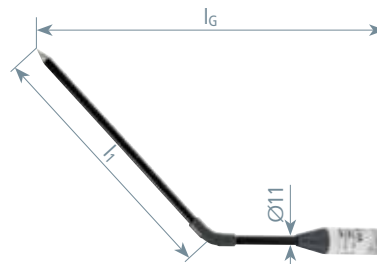

Type PSO M8 ...	W45 PHE
Part No.	766 941
Nominal voltage (U _N)	3 ... 24 kV
Diameter	11 mm
Total length (l _G)	395 mm
Length (l ₁)	280 mm
Not suitable for use in wet weather conditions	☀



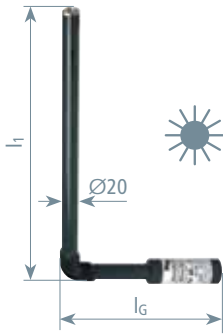

Test Probe, 90° angled

For switchgear installations with a limited tulip-shaped access from bottom to top.

Type PSO M8 ...	W90 PHE
Part No.	766 950
Nominal voltage (UN)	3 ... 36 kV
Diameter	20 mm
Total length (lG)	200 mm
Length (l1)	370 mm
Not suitable for use in wet weather conditions	☀

Test probes for other special switchgear installations are available on request.

Adapters and End Fittings



Adapter (Plug-In Coupling / T Pin Shaft)

For extending the handle of IS ... STK insulating sticks by an ES SQ or ES SQL earthing stick.

Type	AD HV STK SQ
Part No.	766 313
Total length (lG)	275 mm



End Fitting STK (Plug-in Coupling)

For use as termination and protection

Type	A STK
Part No.	766 888
Diameter	30 / 43 mm
Total length (lG)	85 mm



End Fitting STK with Eye

For use as protection and transport eye when working on overhead lines.

Type	AR STK
Part No.	766 889
Diameter	30 / 43 mm
Total length (lG)	150 mm

Storage Devices

- Wall-mounted
- Easy and safe storage of earthing and short-circuiting devices, voltage detectors and operating sticks Ø30 oder 43 mm

For a Voltage Detector and an Earthing Stick

For a voltage detector and an earthing stick of any length
Hole spacing: 290/390 mm, holes: Ø7 mm

Type HV ...	P ST D24	P ST D30	P ST D40 45
Part No.	700 006	700 007	700 008
For stick diameters	24 mm	30 mm	40 ... 45 mm
Dimensions	530 x 30 x 136 mm	430 x 30 x 136 mm	530 x 30 x 149 mm
DB material No.	—	828 077	—



For an Earthing and Short-Circuiting Device and an Earthing Stick

For an earthing and short-circuiting device and an earthing stick of any length
Hole spacing: 424 mm, holes: Ø7 mm

Type HV ...	EKV ES30	EKV ES40
Part No.	700 000	700 002
For stick diameters	30 mm	43 mm
Dimensions	525 x 175 x 214 mm	525 x 175 x 214 mm
DB drawing No.	3 Ebgw 01.70	—
DB material No.	742 395	—



For an Earthing and Short-Circuiting Device and an Earthing Stick up to 1.5 m

For an earthing and short-circuiting device and an earthing stick with a length up to 1.5 m
Hole spacing: 104 mm, holes: Ø7 mm

Type HV ...	EKV ES30 1500
Part No.	700 003
For stick diameters	30 / 43 mm
Dimensions	214 x 150 mm



For HH Fuses and a Fuse Tong – Single Parts

Wall-mounted, holes Ø7 mm

Type HV ...	3HH ET	3HH SZ ET
Part No.	700 005	700 004
For	HH fuses	HH fuses and a fuse tong

Note: Two storage devices are required!

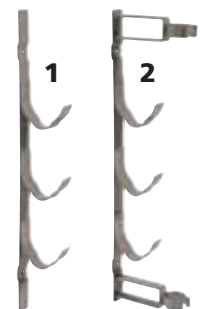

For HH Fuses and a Fuse Tong – Kit

Wall-mounted, holes Ø7 mm

Kit includes:			
Kit Type	Kit Part No.	consisting of:	Pos. No.
HV 3HH	700 015	2x 700 005	1
HV 3HH SZ	700 014	1x 700 005 1x 700 004	1 2

Type HV ...	3HH	3HH SZ
Part No.	700 015	700 014
For	3 HH fuses	3 HH fuses and a fuse tong

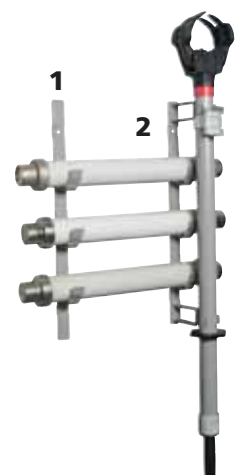

Fastening Material

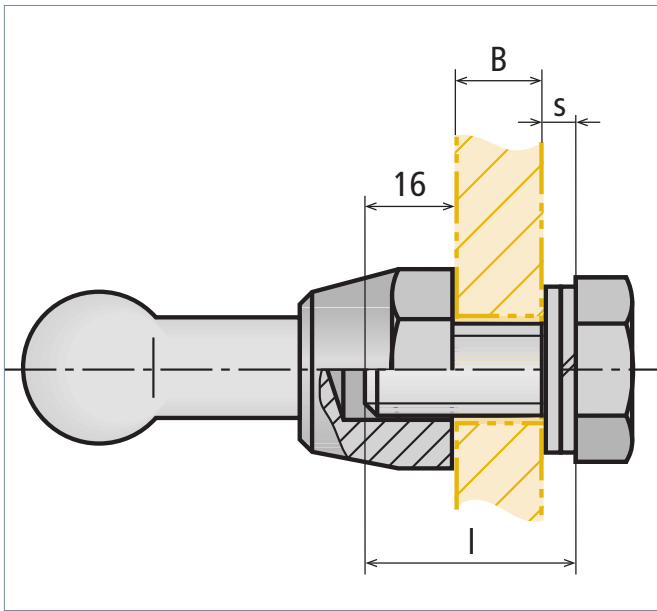

For Fixed Ball and Earthing Points

- Hexagon bolt for fixing busbar connections according to DIN 43673-1
- Resilient pressure plate for installing M12 or M16 fixed points on aluminium busbars

Determination of the bolt length l

$$l \text{ (mm)} = B + s + 16$$

Important! Required bolt length < l

l = Bolt length

B = Thickness of the busbar

s = Thickness of the spring washer and washer

General Information:

Standard (hexagon bolts)	In accordance with DIN 933 and DIN 43673-1
Standard (spring washers)	In accordance with DIN 128
Standard (washers)	In accordance with DIN 125

Determination of the required bolt length

Hexagon Bolts



Type	SKS M12X25 V2A	SKS M12X30 V2A	SKS M12X35 V2A	SKS M16X30 V2A
Part No.	561 925	561 930	561 935	561 931
Dimensions	M12 x 25 mm	M12 x 30 mm	M12 x 35 mm	M16 x 30 mm
Material	StSt A2-70	StSt A2-70	StSt A2-70	StSt A2-70
Tightening torque	80 Nm	80 Nm	80 Nm	150 Nm

Spring Washers



Type	FR A12 V2A	FR A16 V2A
Part No.	524 912	524 913
Dimensions	A12 (s = 2.4) mm	A16 (s = 2.8) mm
Material	StSt A2-70	StSt A2-70

Washers



Type	SCH A13 V2A	SCH A17 V2A
Part No.	525 912	525 916
Dimensions	A13 (s = 2.4) mm	A17 (s = 3.0) mm
Material	StSt A2-70	StSt A2-70

Resilient Square Pressure Plate

For reliable contact and permanent installation of fixed ball points on aluminium busbars. Pressure plates must be shimmed on both sides of the busbar.



Type	DP 40 40 B13 AL	DP 50 50 B17 AL
Part No.	525 001	525 002
Dimensions	M12, 40 x 40 x 6 mm	M16, 50 x 50 x 8 mm
Material	Highly resistant Al alloy	Highly resistant Al alloy

Spare Parts

Electric Bulb

Type	GL 3.5V 0.2A E10
Part No.	766 605
Description	Small electric bulb 3.5 V / 0.2 A
Suitable for	PHE



Mignon Battery

Type	MZ 1.5V L91 FR6 LI 4	MZ 1.5 IEC LR6 AL
Part No.	766 611	766 618
Description	Mignon battery 1.5 V, lithium	Mignon battery 1.5 V, alkaline manganese
PU	4 pieces	1 piece



Block Battery

Type	EB 9V LI	EB 9V AL
Part No.	767 712	767 713
Description	9 V E block battery, lithium	9 V E block battery, alkaline manganese
PU	1 piece	1 piece



Protective Rubber for PHE

Type	FSG PHE
Part No.	767 776
Suitable for	PHE



Protective Rubber for PHG II and PHV

Type	FSG PHG2 PHV
Part No.	767 777
Suitable for	PHG II and PHV



Sealing Ring

Type	DR PS PHE3	DR PHV
Part No.	767 779	767 778
Suitable for	PHE III test prod and ASP electric field sensor	PHV test unit



Plastic Star Grip Screw

Type	KS SG BLS 8
Part No.	766 105
Suitable for	Universal gear coupling
Total length (l _G)	42 mm



Support

Type	AH ISMTC
Part No.	766 038
Suitable for	Telescopic insulating stick





- Test prod with integrated test electrode allows safe contact with the part of an installation to be tested

General Information:

Colour	Grey ● or yellow ●
Diameter	20 mm
Material (test electrode)	Cu alloy/gal Sn
Material (test prod)	Glass-fibre reinforced epoxy resin tube

For PHE III up to 30 kV / Category "S"

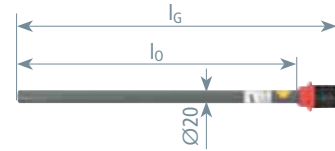

Type	S60 PS PHE 285	S61 PS PHE 435	S62 PS PHE 620	S63 PS PHE 780	S64 PS PHE 880
Part No.	767 760	767 761	767 762	767 763	767 764
Total length (l_G)	320 mm	470 mm	655 mm	815 mm	915 mm
Insertion depth (l_o)	285 mm	435 mm	620 mm	780 mm	880 mm

For PHE III above 30 kV / Category "S"

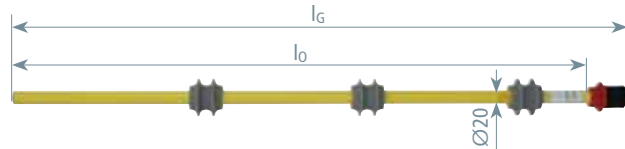

Type	S66 PS PHE 880	S66PS PHE880 C SN7771
Part No.	767 771	769 701
Total length (l_G)	915 mm	915 mm
Insertion depth (l_o)	880 mm	880 mm
Type	—	Coded

For PHE III up to 30 kV / Category "L"

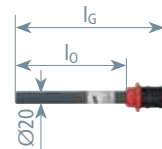

Type	L71 PS PHE 185
Part No.	767 766
Total length (l_G)	220 mm
Insertion depth (l_o)	185 mm

For Siemens 8CK Switchgear Installations

Category "S" for voltage detector PHE III Part No. 767 721, 767 951, 767 722, 767 740 and 767 940.



Type	S63 PS PHE 8CK
Part No.	767 768
Total length (l_G)	880 mm
Insertion depth (l_o)	845 mm

For Mipak Switchgear Installations

Category "S" for voltage detectors (and indicators) PHE III Part Nos. 767 731 (767 796), 767 750 (767 728), 767 961 (767 956) and 767 950 (767 968).

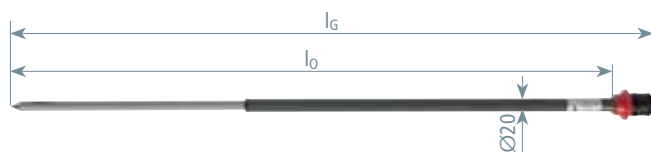

Type	S65 M PS PHE 905
Part No.	767 767
Total length (l_G)	940 mm
Insertion depth (l_o)	905 mm

Kit Parts

For PHE 15 kV / 16.7 Hz



Type	PS PHE 15 16.7
Part No.	766 619
Total length (l _G)	1060 mm



Other versions are available on request.

Indicators / Indicators with Test Prod

PHE (Voltage Detector for Overhead Lines)

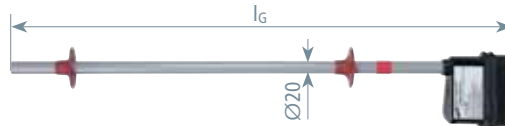

Type	PHE A 15 16.7
Part No.	766 677
Nominal voltage (U _N)	15 kV / 16.7 Hz
Total length (l _G)	930 mm
DB drawing No.	3 Ebgw 02.53



Test Prod PHE (Voltage Detector for Overhead Lines)

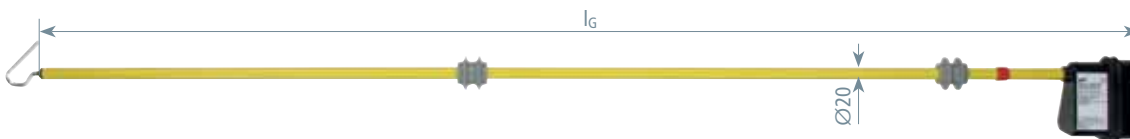

Type	PHE PK 15 16.7
Part No.	766 678
Nominal voltage (U _N)	15 kV / 16.7 Hz
Total length (l _G)	1900 mm
DB drawing No.	3 Ebgw 02.51



PHE III, with M12 Threaded Pin

Type	PHE3 A 60 110 S	PHE3A60110SITCSN7772
Part No.	767 734	769 713
Nominal voltage (U _N)	60 ... 110 kV	60 ... 110 kV
Category	S	S
Total length (l _G)	190 mm	190 mm
Type	—	Coded



PHE III, with Gear Coupling

Type	PHE3 A 20 SL ZK
Part No.	767 722
Nominal voltage (U _N)	20 kV
Category	S / L
Total length (l _G)	230 mm



ASP, with Gear Coupling

Category "S" and "L".

Type ASP A...	110 132 16.7 L	110 420 L ZK	110 420 S ZK	110 420 SL ZK
Part No.	767 564	767 591	767 592	767 593
Nominal voltage (U _N)	110 ... 132 kV	110 ... 420 kV	110 ... 420 kV	110 ... 420 kV
Frequency	16.7 Hz	50 Hz	50 Hz	50 Hz
Category	L	L	S	S / L
Total length (l _G)	230 mm	230 mm	230 mm	230 mm



Field Sensor



Electric field sensors for ASP distance voltage detectors.

- For use in wet weather conditions

Category L



Type EFS ...	L 127
Part No.	767 576
Category	L
Total length (l _G)	127 mm
For use in wet weather conditions	

Category S



Type EFS ...	S 167
Part No.	767 577
Category	S
Total length (l _G)	167 mm
For use in wet weather conditions	

Operating Heads

STK Switching Stick Head

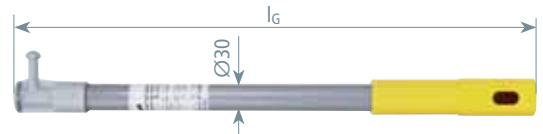

Type	SSK 36 STK 560	SSK 36 STK 930SN7689
Part No.	766 164	766 169
Diameter	30 mm	30 mm
Total length (l _G)	560 mm	930 mm

STK Operating Head / T Pin Shaft

For indoor use.

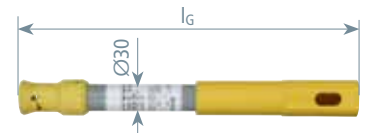

Type	AK 36 SQ STK 360
Part No.	766 365
Diameter	30 mm
Total length (l _G)	360 mm

STK Operating Head / long T Pin Shaft

Aluminium cone coupling with adjusting ring (bayonet locking mechanism) for earthing and short-circuiting in outdoor installations.

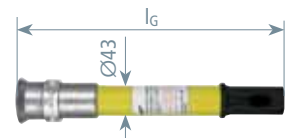

Type	AK SQL STK 365
Part No.	766 465
Diameter	43 mm
Total length (l _G)	365 mm

STK Operating Head / Hexagon Shaft

For indoor use.

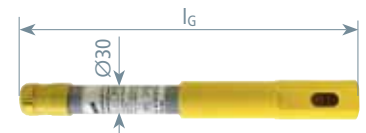

Type	AK 36 SK STK 330
Part No.	766 364
Diameter	30 mm
Total length (l _G)	330 mm

Kit Parts

Screw-on Switching Stick Head for IS SK Insulating Sticks

With M12 thread.

In accordance with E DIN VDE V 0681-2.

Type	SSK M12
Part No.	765 005
Material	Steel, plastic-sheathed



Switching Stick Head for IS SQ Insulating Sticks

With T pin shaft (bayonet locking mechanism).

In accordance with E DIN VDE V 0681-2.

T pin shaft in accordance with DIN 48087.

Switching stick head is fixed on the insulating stick via the knurled nut.

Type	SSK SQ
Part No.	765 009
Material	Polyamide



SQL Operating Head

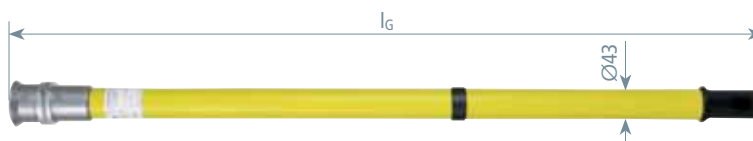

Type	ES SQL STK 43 1045
Part No.	766 074
Diameter	43 mm
Total length (l_G)	1045 mm
DB drawing No.	3 Ebgw 01.68

SQL Operating Head with Aluminium Plug-In Coupling



Type	ES SQL ALSTK 1035
Part No.	769 516
Diameter	43 mm
Total length (l_G)	1035 mm

Contacting Aid

For telescopic insulating sticks.



Type	AK AH ZK ISMTC
Part No.	766 049
Total length (l_G)	340 mm

Cleaning Head

Flexibly adjustable, for attaching cleaning pads.

Type	RK 230 100 AS25
Part No.	766 056
Diameter	25 mm
Dimensions	230 x 100 mm



Accessory for Cleaning Head

Rectangular Cleaning Pad

Type	RP 250 115 20
Part No.	766 057
Dimensions	250 x 115 x 20 mm
PU	5 pc(s)



Insulating Sticks

For ASP, with universal Gear Coupling
 Plug-in coupling for extending the handle.

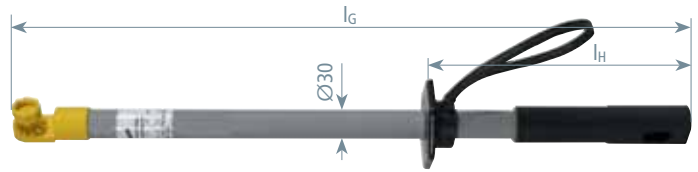

Type	IS ZK STK HS 670
Part No.	766 369
Diameter	30 mm
Total length (l_G)	670 mm
Length (handle) (l_H)	270 mm
Material	Glass-fibre reinforced polyester tube

For PHE III, with M12 Threaded Bushing
 With plug-in coupling for extending the handle.

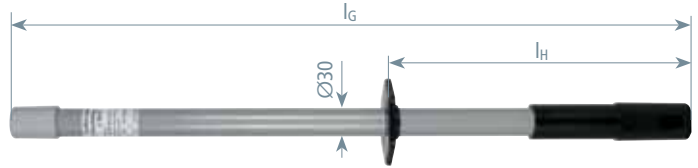

Type	IS M12 STK 640
Part No.	766 331
Diameter	30 mm
Total length (l_G)	640 mm
Length (handle) (l_H)	270 mm
Material	Glass-fibre reinforced polyester tube

For PHE III, with M12 Threaded Bushing
 With end cap.

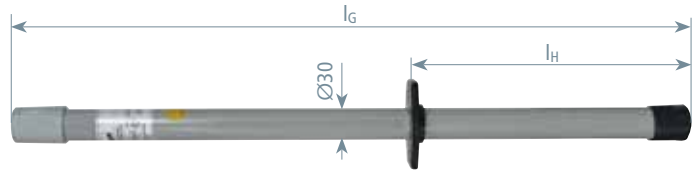

Type	IS M12 AK 635
Part No.	766 328
Diameter	30 mm
Total length (l_G)	635 mm
Handle length (l_H)	270 mm
Material	Glass-fibre reinforced polyester tube

For PHE III, with universal Gear Coupling
 Handle end fitting with plastic plug-in coupling as extension handle.

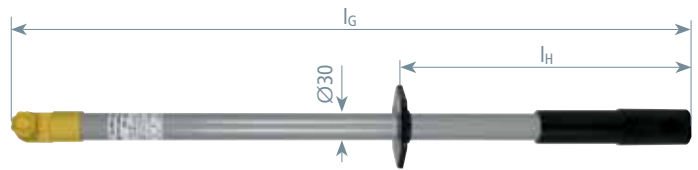

Type	IS ZK STK 670
Part No.	766 368
Diameter (U_N)	30 kV
Total length (l_G)	670 mm
Length (handle) (l_H)	265 mm
Material	Glass-fibre reinforced polyester tube

For IS for cleaning Windscreens
 Consists of one element, with foam-filled insulating element.

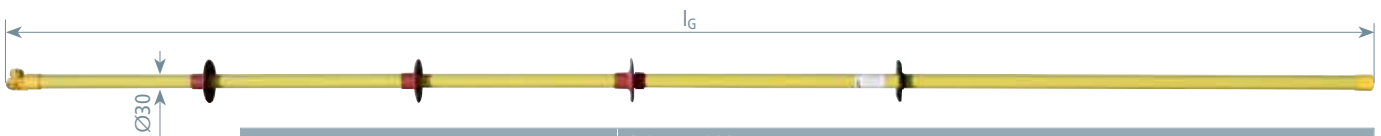

Type	IS 25 ZK 2885
Part No.	766 048
Diameter	30 mm
Total length (l_G)	2890 mm
Material	Glass-fibre reinforced polyester tube

Kit Parts

Telescopic Insulating Stick, with universal Gear Coupling

With scale for measuring the ground clearance, mounted support included.



Type	ISMTC N 36 ZK 10600
Part No.	766 037
Nominal voltage (U _N)	Up to 36 kV
Total length (l _{G max} / l _{G min})	10,600 / 1750 mm
Material	Glass-fibre reinforced epoxy resin tube

For IS STK, with Plug-in Coupling

Plug-in coupling at both ends for attaching extension elements, operating heads or adapters.

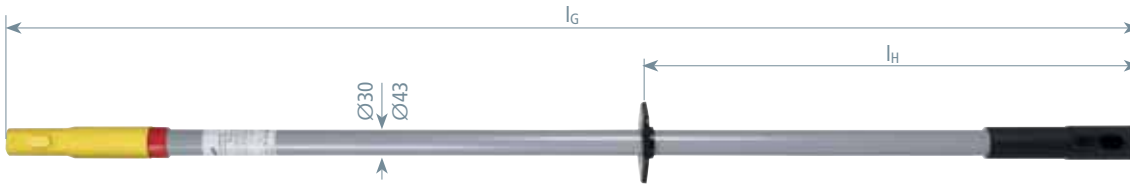

Type	IS 36 STK 30 1280	IS 36 STK 43 1280
Part No.	766 363	766 463
Diameter	30 mm	43 mm
Total length (l _G)	1280 mm	1280 mm
Length (handle) (l _H)	560 mm	560 mm
Material	Glass-fibre reinforced polyester tube	Glass-fibre reinforced polyester tube

ISN 36 STK Insulating Stick with Silicon Insulator

Plug-in coupling at both ends for attaching extension elements, operating heads or adapters.

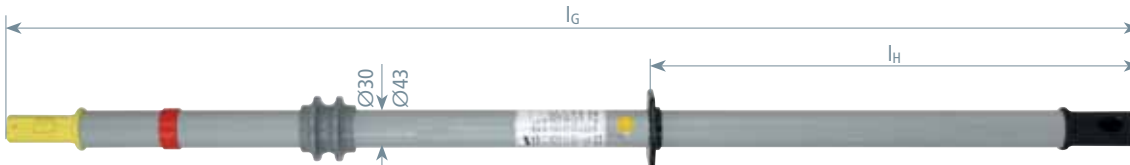

Type ISN 36 STK ...	30 1280	930SN7688	43 1280
Part No.	766 367	766 362	766 468
Diameter	30 mm	30 mm	43 mm
Total length (l _G)	1280 mm	930 mm	1280 mm
Length (handle) (l _H)	560 mm	190 mm	560 mm
Material	Glass-fibre reinforced polyester tube	Glass-fibre reinforced polyester tube	Glass-fibre reinforced polyester tube

For PHE (Voltage Detectors for Overhead Lines)

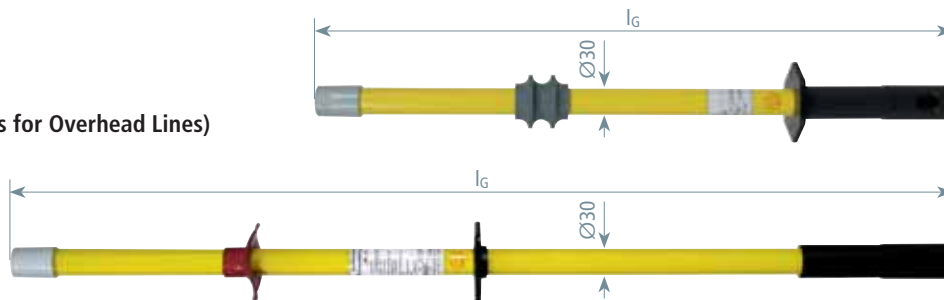

Type	IS M12 STK 30 720	IS M12 STK 30 1060
Part No.	766 072	766 075
Diameter	30 mm	30 mm
Total length (l _G)	720 mm	1060 mm
DB drawing No.	3 Ebgw 02.51	3 Ebgw 02.53



Insulating Elements

Insulating Element with M12 Threaded Bushing

With plug-in coupling for the handle.

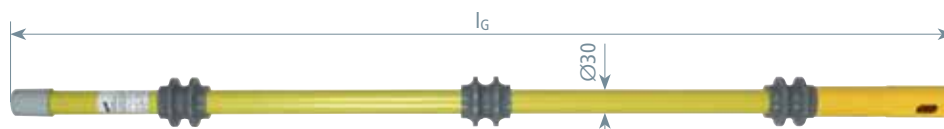

Type	ISO M12 STK 30SN7563	IT M12 STK 30 1150
Part No.	766 116	766 115
Nominal voltage (U _N)	up to 110 kV	up to 110 kV
Diameter	30 mm	30 mm
Total length (l _G)	780 mm	1150 mm

Insulating Element with Hand Guard

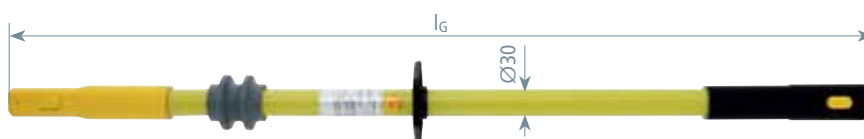

Type	ISU STK STK 30SN7564
Part No.	766 117
Nominal voltage	up to 110 kV
Diameter	30 mm
Total length (l _G)	930 mm

Insulating Element with Gear Coupling

With plug-in coupling.

Setting angle of the gear coupling: - 30° / 0° / + 30°.

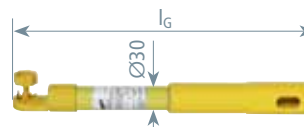

Type	IT ZK30 STK 30 360
Part No.	766 358
Diameter	30 mm
Total length (l _G)	360 mm

Handle / Extensions

Handle

End fitting with plug-in coupling for extending the handle.

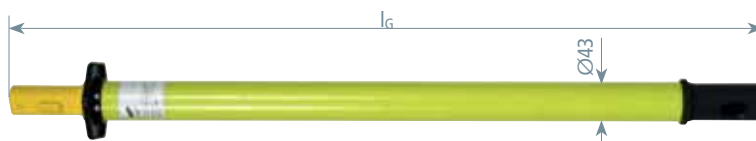

Type	H STK 43 800		
Part No.	766 120		
Diameter	43 mm		
Total length (l _G)	830 mm		

ISV 36 STK Insulating Stick Extension

Plug-in coupling at both ends for extending the insertion depth or the handle.

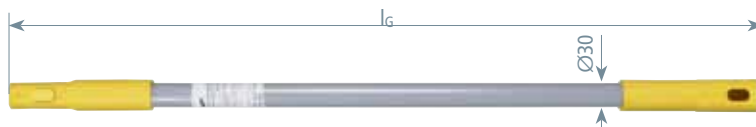

Type	ISV 36 STK 30 910	ISV 36 STK 30 1280
Part No.	766 356	766 366
Diameter	30 mm	30 mm
Total length (l _G)	910 mm	1280 mm

HV STK Extension Handle

Plug-in coupling at both ends for extending the handle.

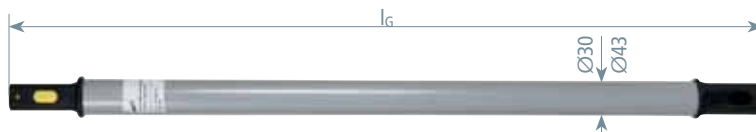

Type	HV STK 30 710	HV STK 43 910	HV STK 43 1280
Part No.	766 335	766 456	766 466
Diameter	30 mm	43 mm	43 mm
Total length	710 mm	910 mm	1280 mm

Extension Handle

Plug-in coupling at both ends for extending the handle.



Type	HV STK 43 975	HV STK 43 1045	HV STK 43 2350
Part No.	766 077	766 076	766 073
Diameter	43 mm	43 mm	43 mm
Total length (l _G)	975 mm	1045 mm	2350 mm
DB drawing No.	3 Ebgw 02.53	3 Ebgw 02.53	3 Ebgw 02.51



Extension Handle



Type	HV STK RW 43 975	HV STK RW 43 1045
Part No.	766 079	766 078
Diameter	43 mm	43 mm
Total length (l _G)	975 mm	1045 mm
DB drawing No.	3 Ebgw 01.68	3 Ebgw 01.68





Extension Handle with Aluminium Plug-In Coupling

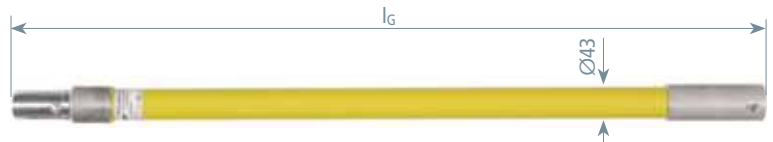

Type	HV ALSTK 1035
Part No.	769 517
Diameter	43 mm
Total length (l _G)	1035 mm



RW Extension Handle with Aluminium Plug-In Coupling

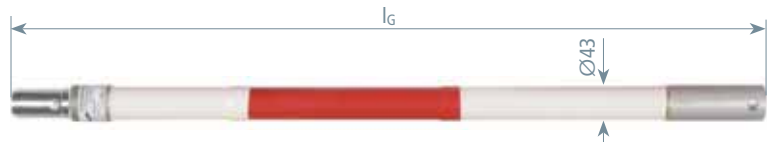

Type	HV ALSTK RW 1035
Part No.	769 518
Diameter	43 mm
Total length (l _G)	1035 mm



RW Extension Handle with Aluminium Plug-In Coupling and Ring Eye

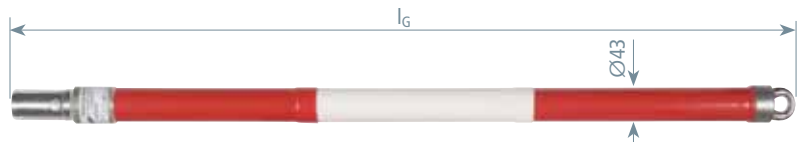

Type	HV ALSTK AK RW 1035
Part No.	769 519
Diameter	43 mm
Total length (l _G)	1035 mm

Adapters

Adapter with M12 Threaded Bushing

With plug-in coupling.

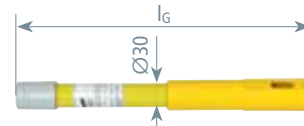

Type	AD M12 STK 30 350
Part No.	766 352
Diameter	30 mm
Total length (l _G)	350 mm

Adapter with Gear Coupling

With plug-in coupling.

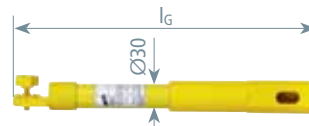

Type	AD ZK STK 30 360
Part No.	766 359
Diameter	30 mm
Total length (l _G)	360 mm

Adapter with Cone-shaped Support

With gear coupling and cone-shaped support, accommodates cleaning sponges (Part No. 766 056).

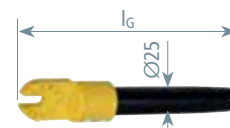

Type	AD ZK 25 200
Part No.	766 055
Diameter	25 mm
Dimensions	200 mm

Part No. / GTIN* / PG / Weight / PU / SU / Page

Part No.	GTIN*	PG	Weight	PU	SU	Page
336 020	003941	5-3-1	118 g	1	pc(s)	62
336 025	003958	5-3-1	252 g	1	pc(s)	62
524 912	039360	1-6-1	4 g	1	pc(s)	170
524 913	053250	1-6-1	8 g	1	pc(s)	170
525 001	004986	5-3-1	19 g	10	pc(s)	170
525 002	004993	5-3-1	37 g	10	pc(s)	170
525 912	053267	1-6-1	5 g	1	pc(s)	170
525 916	053274	1-6-1	10 g	1	pc(s)	170
561 925	056244	1-6-1	35 g	1	pc(s)	170
561 930	053298	1-6-1	39 g	1	pc(s)	170
561 931	053311	1-6-1	77 g	1	pc(s)	170
561 935	056053	1-6-1	42 g	1	pc(s)	170
644 000	030268	3-7-1	4.45 kg	1	pc(s)	77
700 000	004122	5-3-4	1.16 kg	1	pc(s)	169
700 002	004139	5-3-4	1.15 kg	1	pc(s)	169
700 003	004146	5-3-4	700 g	1	pc(s)	169
700 004	004153	5-3-4	1 kg	1	pc(s)	169
700 005	004160	5-3-4	707 g	1	pc(s)	169
700 006	004177	5-3-4	780 g	1	pc(s)	169
700 007	004184	5-3-4	780 g	1	pc(s)	169
700 008	004191	5-3-4	803 g	1	pc(s)	169
700 014	007208	5-3-4	1.71 kg	1	pc(s)	169
700 015	007192	5-3-4	1.41 kg	1	pc(s)	169
700 098	157422	5-1-8	180 g	1	Sa	155
700 099	157415	5-1-8	1.28 kg	1	m	155
705 500	000025	5-3-1	122 g	1	pc(s)	63
705 501	003927	5-3-1	152 g	1	pc(s)	62
705 504	008021	5-3-1	183 g	1	pc(s)	63
705 510	089587	5-3-1	240 g	1	pc(s)	63
706 200	004276	5-3-1	172 g	1	pc(s)	61
706 235	004290	5-3-1	219 g	1	pc(s)	60
706 300	003675	5-3-1	129 g	1	pc(s)	59
706 600	004283	5-3-1	158 g	1	pc(s)	61
706 645	004306	5-3-1	274 g	1	pc(s)	60
707 200	004368	5-3-1	204 g	1	pc(s)	61
707 235	004382	5-3-1	259 g	1	pc(s)	61
707 600	004375	5-3-1	191 g	1	pc(s)	61
707 645	004399	5-3-1	299 g	1	pc(s)	61
712 001	011823	5-3-0	1.23 kg	1	m	70
715 001	011830	5-3-0	1.52 kg	1	m	70
715 312	150386	5-4-1	1.5 kg	1	pc(s)	72
716 001	010406	5-3-0	184 g	1	m	70
720 010	077935	5-3-1	314 g	1	pc(s)	60
720 012	077942	5-3-1	347 g	1	pc(s)	60
720 014	077959	5-3-1	329 g	1	pc(s)	60
720 016	003729	5-3-1	309 g	1	pc(s)	60
720 018	077973	5-3-1	296 g	1	pc(s)	60
720 020	077980	5-3-1	276 g	1	pc(s)	60
723 199	151703	5-7-4	750 g	1	pc(s)	153
725 001	011793	5-3-0	207 g	1	m	70
725 010	003750	5-3-1	410 g	1	pc(s)	60
725 012	003767	5-3-1	400 g	1	pc(s)	60

Part No.	GTIN*	PG	Weight	PU	SU	Page
725 014	003774	5-3-1	385 g	1	pc(s)	60
725 016	003781	5-3-1	365 g	1	pc(s)	60
725 018	078048	5-3-1	345 g	1	pc(s)	60
725 020	003804	5-3-1	320 g	1	pc(s)	60
728 312	128712	5-3-1	270 g	1	pc(s)	75
728 313	157132	5-3-1	612 g	1	pc(s)	75
728 501	079618	5-5-2	900 g	1	pc(s)	64
728 502	079571	5-5-2	708 g	1	pc(s)	64
728 503	079564	5-5-2	453 g	1	pc(s)	64
728 506	147904	5-3-1	867 g	1	pc(s)	64
728 516	147898	5-3-1	1.44 kg	1	pc(s)	64
728 522	147874	5-3-1	676 g	1	pc(s)	64
728 526	147881	5-3-1	934 g	1	pc(s)	64
728 620	147843	5-3-1	985 g	1	pc(s)	63
728 625	147867	5-3-1	984 g	1	pc(s)	63
731 011	004771	5-4-3	690 g	1	pc(s)	65
731 013	004795	5-4-3	850 g	1	pc(s)	65
731 015	004801	5-4-3	1 kg	1	pc(s)	65
731 027	004818	5-4-3	1.97 kg	1	pc(s)	65
731 037	005044	5-4-3	2.66 kg	1	pc(s)	65
735 001	011847	5-3-0	366 g	1	m	70
740 124	051072	5-5-2	255 g	1	pc(s)	98
745 016	052000	5-6-1	467 g	1	pc(s)	106
745 017	052017	5-6-1	277 g	1	pc(s)	106
745 018	052048	5-6-1	271 g	1	pc(s)	106
745 105	104457	5-6-3	1.83 kg	1	pc(s)	110
745 106	104495	5-6-2	890 g	1	pc(s)	110
745 107	104501	5-6-0	286 g	1	pc(s)	110
745 108	104518	5-6-2	20 g	1	pc(s)	111
745 109	104525	5-6-2	18 g	1	pc(s)	111
745 201	008007	5-6-1	65 g	1	pc(s)	106
745 202	007871	5-6-1	90 g	1	pc(s)	106
745 203	008014	5-6-1	102 g	1	pc(s)	107
745 204	018655	5-6-1	145 g	1	pc(s)	107
745 302	052024	5-6-1	110 g	1	pc(s)	106
745 400	006959	5-6-2	250 g	1	pc(s)	107
745 414	116085	5-4-2	285 g	1	pc(s)	112
745 415	116092	5-4-2	275 g	1	pc(s)	112
745 500	007888	5-6-3	7.57 kg	1	pc(s)	104
745 502	072213	5-6-1	360 g	1	pc(s)	107
745 503	133570	5-6-1	154 g	1	pc(s)	103
745 508	149366	5-6-1	137 g	1	pc(s)	107
745 602	072220	5-6-1	580 g	1	pc(s)	107
745 900	082731	5-6-2	3.71 kg	1	pc(s)	161
745 901	083530	5-6-3	6.89 kg	1	pc(s)	101
745 902	093591	5-6-2	1.62 kg	1	pc(s)	162
745 903	093577	5-6-3	7 kg	1	pc(s)	101
745 905	082021	5-6-1	75 g	1	pc(s)	103
745 910	082038	5-6-1	190 g	1	pc(s)	103
745 915	082045	5-6-1	420 g	1	pc(s)	103
745 921	082069	5-6-2	220 g	1	pc(s)	103
745 922	082434	5-6-2	220 g	1	pc(s)	103
745 952	137066	5-6-2	4.9 kg	1	pc(s)	162
745 953	137073	5-6-2	4.95 kg	1	pc(s)	162
750 001	011809	5-3-0	535 g	1	m	70
750 041	126688	5-5-1	4.22 kg	1	pc(s)	97
750 042	126695	5-5-1	3.89 kg	1	pc(s)	97
750 196	123823	5-5-0	26.58 kg	1	pc(s)	92
750 200	123830	5-5-0	16.95 kg	1	pc(s)	94
750 210	123793	5-5-0	13.44 kg	1	pc(s)	92

Part No.	GTIN*	PG	Weight	PU	SU	Page
750 211	123809	5-5-0	15.55 kg	1	pc(s)	93
750 212	123847	5-5-1	13 kg	1	pc(s)	94
750 213	123861	5-5-1	8.76 kg	1	pc(s)	95
750 214	123816	5-5-0	15.6 kg	1	pc(s)	93
750 215	123878	5-6-3	7.3 kg	1	pc(s)	95
750 216	157255	5-5-0	26.58 kg	1	pc(s)	92
750 217	157262	5-5-0	17.08 kg	1	pc(s)	94
750 218	157224	5-5-0	14.73 kg	1	pc(s)	92
750 219	157231	5-5-0	16.87 kg	1	pc(s)	93
750 221	157248	5-5-0	15.51 kg	1	pc(s)	93
750 500	000032	5-3-1	250 g	1	pc(s)	63

751 040	006041	5-5-2	2.6 kg	1	pc(s)	98
751 085	006058	5-5-2	4.98 kg	1	pc(s)	98
751 086	126626	5-5-0	8.99 kg	1	pc(s)	96
751 087	126633	5-5-0	9.13 kg	1	pc(s)	96
751 120	006065	5-5-2	6.86 kg	1	pc(s)	98
751 121	126640	5-5-0	11.14 kg	1	pc(s)	96
751 122	126657	5-5-0	11.41 kg	1	pc(s)	96
751 126	126664	5-5-0	10.88 kg	1	pc(s)	96
751 127	126671	5-5-0	11.01 kg	1	pc(s)	96
751 130	041776	5-5-2	7.39 kg	1	pc(s)	98
751 140	018570	5-5-2	7.93 kg	1	pc(s)	98
751 150	084520	5-3-0	4.53 kg	1	pc(s)	97
751 191	126602	5-5-1	8.82 kg	1	pc(s)	97
751 192	123885	5-5-1	6.68 kg	1	pc(s)	98
751 193	123892	5-5-1	10.28 kg	1	pc(s)	97
751 196	157767	5-5-1	8.53 kg	1	pc(s)	98
751 197	157774	5-5-1	14.41 kg	1	pc(s)	98

752 040	230187	5-5-0	1.09 kg	1	pc(s)	98
752 041	230569	5-5-0	3.18 kg	1	pc(s)	97
752 042	230576	5-5-0	3.57 kg	1	pc(s)	97
752 085	230637	5-5-0	2.32 kg	1	pc(s)	98
752 086	230217	5-5-0	7.02 kg	1	pc(s)	96
752 087	230422	5-5-0	7.33 kg	1	pc(s)	96
752 120	230644	5-5-0	3.28 kg	1	pc(s)	98
752 121	230316	5-5-0	8.32 kg	1	pc(s)	96
752 122	230453	5-5-0	8.48 kg	1	pc(s)	96
752 126	230262	5-5-0	8.05 kg	1	pc(s)	96
752 127	230439	5-5-0	8.21 kg	1	pc(s)	96
752 130	245594	5-5-2	3.5 kg	1	pc(s)	98
752 140	245617	5-5-2	3.83 kg	1	pc(s)	98
752 191	230330	5-5-0	6.34 kg	1	pc(s)	97
752 192	230590	5-5-0	4.66 kg	1	pc(s)	98
752 193	230538	5-5-0	7.38 kg	1	pc(s)	97
752 196	230545	5-5-0	6.52 kg	1	pc(s)	98
752 197	230552	5-5-0	7.55 kg	1	pc(s)	98

754 200	004207	5-3-1	131 g	1	pc(s)	59
754 205	097865	5-3-1	137 g	1	pc(s)	59
754 235	004221	5-3-1	184 g	1	pc(s)	59
754 600	004214	5-3-1	116 g	1	pc(s)	59
754 645	004238	5-3-1	287 g	1	pc(s)	59

755 200	000087	5-3-1	220 g	1	pc(s)	59
755 225	004498	5-3-1	265 g	1	pc(s)	59
755 245	000070	5-3-1	278 g	1	pc(s)	59
755 501	003934	5-3-1	298 g	1	pc(s)	62
755 600	000094	5-3-1	204 g	1	pc(s)	59
755 626	079625	5-5-2	301 g	1	pc(s)	60
755 627	077768	5-5-2	311 g	1	pc(s)	60
755 636	079670	5-5-2	310 g	1	pc(s)	60
755 645	000100	5-3-1	319 g	1	pc(s)	59
755 646	079632	5-5-2	330 g	1	pc(s)	60

Part No.	GTIN*	PG	Weight	PU	SU	Page
756 200	004313	5-3-1	357 g	1	pc(s)	61
756 245	004337	5-3-1	434 g	1	pc(s)	60
756 300	003682	5-3-1	212 g	1	pc(s)	59
756 600	004320	5-3-1	356 g	1	pc(s)	61
756 645	004344	5-3-1	470 g	1	pc(s)	60

757 200	004405	5-3-1	395 g	1	pc(s)	61
757 245	004429	5-3-1	454 g	1	pc(s)	61
757 600	004412	5-3-1	370 g	1	pc(s)	61
757 645	004436	5-3-1	491 g	1	pc(s)	61

758 001	004030	5-7-2	2.22 kg	1	pc(s)	158
758 003	004047	5-7-2	1.95 kg	1	pc(s)	158
758 015	041608	5-7-2	2.62 kg	1	pc(s)	158
758 020	098992	5-7-2	1.34 kg	1	pc(s)	157
758 021	099005	5-7-2	1.1 kg	1	pc(s)	157
758 022	099012	5-7-2	650 g	1	pc(s)	157
758 025	127838	5-7-2	1.49 kg	1	pc(s)	159
758 028	132450	5-7-2	4.16 kg	1	pc(s)	159
758 031	229853	5-7-2	2.1 kg	1	pc(s)	159

759 003	105942	5-1-7	6.2 kg	1	pc(s)	161
759 111	010376	5-1-6	200 g	1	pc(s)	47
759 121	013971	5-1-6	154 g	1	pc(s)	47
759 300	125964	5-1-6	1.2 kg	1	pc(s)	46
759 603	097469	5-1-6	205 g	1	pc(s)	46
759 604	097537	5-1-6	349 g	1	pc(s)	47
759 605	097476	5-1-6	336 g	1	pc(s)	46
759 608	097544	5-1-6	295 g	1	pc(s)	47
759 610	097483	5-1-6	405 g	1	pc(s)	46
759 611	097551	5-1-6	346 g	1	pc(s)	47
759 615	097520	5-1-6	400 g	1	pc(s)	46
759 620	097490	5-1-6	340 g	1	pc(s)	46
759 621	097513	5-1-6	370 g	1	pc(s)	47
759 622	097568	5-1-6	425 g	1	pc(s)	47
759 706	259232	5-1-6	1.12 kg	1	pc(s)	48
759 712	259256	5-1-6	1.12 kg	1	pc(s)	48
759 716	259270	5-1-6	1.33 kg	1	pc(s)	48
759 736	259263	5-1-6	1.33 kg	1	pc(s)	48
759 998	115309	5-1-7	3.32 kg	1	pc(s)	162
759 999	115293	5-1-7	2.38 kg	1	pc(s)	162

761 001	125179	5-3-3	400 g	1	pc(s)	83
761 002	125186	5-3-3	400 g	1	pc(s)	83
761 003	134348	5-3-3	840 g	1	pc(s)	83
761 004	134355	5-3-3	1.99 kg	1	pc(s)	83
761 010	000155	5-3-3	980 g	1	pc(s)	82
761 011	000230	5-3-3	1.05 kg	1	pc(s)	82
761 015	000162	5-3-3	1.35 kg	1	pc(s)	82
761 016	000247	5-3-3	1.36 kg	1	pc(s)	82
761 070	136212	5-3-3	800 g	1	pc(s)	83
761 075	136229	5-3-3	800 g	1	pc(s)	83

763 100	125155	5-2-0	600 g	1	pc(s)	14
763 111	137226	5-2-0	580 g	1	pc(s)	14
763 112	248250	5-2-0	860 g	1	pc(s)	14
763 150	125162	5-2-0	600 g	1	pc(s)	14
763 180	134263	5-2-0	850 g	1	pc(s)	14
763 181	137240	5-2-0	2.54 kg	1	pc(s)	15
763 211	081567	5-2-3	–	1	pc(s)	115
763 221	081574	5-2-3	–	1	pc(s)	115
763 231	081581	5-2-3	–	1	pc(s)	115
763 241	081598	5-2-3	–	1	pc(s)	115
763 510	137172	5-2-0	520 g	1	pc(s)	14
763 511	137189	5-2-0	660 g	1	pc(s)	14
763 610	003286	5-2-0	962 g	1	pc(s)	14

Part No. / GTIN* / PG / Weight / PU / SU / Page

Part No.	GTIN*	PG	Weight	PU	SU	Page
763 611	076921	5-2-0	610 g	1	pc(s)	14
763 612	078635	5-2-0	800 g	1	pc(s)	14
763 615	003309	5-2-0	1.42 kg	1	pc(s)	14
763 620	003316	5-2-0	800 g	1	pc(s)	14
763 710	098558	5-2-1	1.2 kg	1	pc(s)	21
763 711	098565	5-2-1	442 g	1	pc(s)	21
763 712	098572	5-2-1	49 g	1	pc(s)	21
765 001	051805	5-1-8	190 g	1	pc(s)	83
765 005	051775	5-2-0	117 g	1	pc(s)	175
765 006	156104	5-1-8	315 g	1	pc(s)	83
765 009	051782	5-2-0	145 g	1	pc(s)	175
765 040	093751	5-2-2	2.13 kg	1	pc(s)	17
765 041	093768	5-2-2	2.28 kg	1	pc(s)	17
765 042	093775	5-2-2	2.59 kg	1	pc(s)	17
765 050	093782	5-2-2	2.15 kg	1	pc(s)	17
765 051	093799	5-2-2	2.29 kg	1	pc(s)	17
765 052	093805	5-2-2	2.59 kg	1	pc(s)	17
766 001	017825	5-2-1	416 g	1	pc(s)	10
766 002	017832	5-2-1	810 g	1	pc(s)	10
766 036	105584	5-1-7	968 g	1	pc(s)	162
766 037	125940	5-2-1	6.56 kg	1	pc(s)	177
766 038	105355	5-2-1	275 g	1	pc(s)	171
766 039	105362	5-1-7	712 g	1	pc(s)	164
766 040	113046	5-2-1	820 g	1	pc(s)	15
766 041	113053	5-2-1	1 kg	1	pc(s)	15
766 042	113060	5-2-1	1.12 kg	1	pc(s)	15
766 048	120433	5-2-1	2.6 kg	1	pc(s)	176
766 049	108059	5-2-1	165 g	1	pc(s)	175
766 055	125063	5-2-1	120 g	1	pc(s)	180
766 056	125070	5-2-1	204 g	1	pc(s)	175
766 057	125087	5-2-1	75 g	1	Sa	175
766 072	126114	5-2-1	400 g	1	pc(s)	177
766 073	126121	5-2-1	1.6 kg	1	pc(s)	179
766 074	120952	5-4-2	1.2 kg	1	pc(s)	175
766 075	120471	5-2-1	520 g	1	pc(s)	177
766 076	120464	5-2-1	800 g	1	pc(s)	179
766 077	120457	5-2-1	740 g	1	pc(s)	179
766 078	120969	5-2-1	1 kg	1	pc(s)	179
766 079	120976	5-2-1	1 kg	1	pc(s)	179
766 100	125117	5-2-1	400 g	1	pc(s)	11
766 105	125988	5-1-8	10 g	1	pc(s)	171
766 111	137295	5-2-1	560 g	1	pc(s)	11
766 115	136038	5-2-1	725 g	1	pc(s)	178
766 116	153073	5-2-1	525 g	1	pc(s)	178
766 117	153080	5-2-1	645 g	1	pc(s)	178
766 120	136052	5-2-1	690 g	1	pc(s)	179
766 122	134249	5-2-1	800 g	1	pc(s)	11
766 164	121751	5-2-1	400 g	1	pc(s)	174
766 169	230675	5-2-0	550 g	1	pc(s)	174
766 210	137257	5-2-1	480 g	1	pc(s)	10
766 211	137271	5-2-1	480 g	1	pc(s)	10
766 215	137264	5-2-1	640 g	1	pc(s)	10
766 216	137288	5-2-1	640 g	1	pc(s)	10
766 222	137301	5-2-1	2.36 kg	1	pc(s)	11
766 298	007864	5-6-2	3.7 kg	1	pc(s)	161
766 300	007628	5-6-2	1.2 kg	1	pc(s)	161
766 301	125124	5-2-1	400 g	1	pc(s)	11
766 302	051317	5-6-3	4.38 kg	1	pc(s)	104
766 310	137318	5-2-1	560 g	1	pc(s)	11
766 311	017856	5-2-1	419 g	1	pc(s)	10
766 313	115040	5-1-8	413 g	1	pc(s)	168
766 315	008281	5-2-1	820 g	1	pc(s)	10
766 322	134256	5-2-1	800 g	1	pc(s)	11
766 328	135765	5-2-1	283 g	1	pc(s)	176

Part No.	GTIN*	PG	Weight	PU	SU	Page
766 331	115002	5-2-1	375 g	1	pc(s)	176
766 332	137325	5-2-1	2.38 kg	1	pc(s)	12
766 335	115033	5-2-1	400 g	1	pc(s)	179
766 340	125056	5-2-1	3 kg	1	pc(s)	22
766 352	136069	5-1-8	250 g	1	pc(s)	180
766 356	121799	5-2-1	400 g	1	pc(s)	179
766 358	136137	5-1-8	200 g	1	pc(s)	178
766 359	134379	5-1-8	200 g	1	pc(s)	180
766 362	230705	5-2-1	635 g	1	pc(s)	177
766 363	121737	5-2-1	600 g	1	pc(s)	177
766 364	128262	5-2-1	240 g	1	pc(s)	174
766 365	121768	5-2-1	200 g	1	pc(s)	174
766 366	121782	5-2-1	600 g	1	pc(s)	179
766 367	137042	5-2-1	600 g	1	pc(s)	177
766 368	115026	5-2-1	340 g	1	pc(s)	176
766 369	125025	5-2-1	388 g	1	pc(s)	176
766 371	139909	5-2-1	560 g	1	pc(s)	20
766 372	139916	5-2-1	1.24 kg	1	pc(s)	20
766 390	282810	5-8-1	1.55 kg	1	pc(s)	18
766 393	282926	5-8-1	153 g	1	pc(s)	19
766 456	121812	5-2-1	800 g	1	pc(s)	179
766 463	121744	5-2-1	1 kg	1	pc(s)	177
766 465	121775	5-2-1	800 g	1	pc(s)	174
766 466	121805	5-2-1	1 kg	1	pc(s)	179
766 468	137059	5-2-1	2.45 kg	1	pc(s)	177
766 469	139893	5-2-1	3.42 kg	1	pc(s)	20
766 542	051706	5-1-3	71 g	1	pc(s)	44
766 543	051683	5-1-7	148 g	1	pc(s)	44
766 544	156111	5-1-3	415 g	1	pc(s)	44
766 548	156128	5-1-3	417 g	1	pc(s)	44
766 601	056596	5-1-7	319 g	1	pc(s)	163
766 602	056626	5-1-7	1.31 kg	1	pc(s)	163
766 603	005860	5-1-7	6 kg	1	pc(s)	161
766 605	054370	5-1-8	2 g	1	pc(s)	171
766 611	146549	5-1-8	94 g	1	Sa	171
766 614	056916	5-6-2	600 g	1	pc(s)	163
766 616	126091	5-1-2	5.09 kg	1	pc(s)	36
766 617	101760	5-1-2	4.95 kg	1	pc(s)	36
766 618	148277	5-1-8	24 g	1	pc(s)	171
766 619	120488	5-1-8	600 g	1	pc(s)	173
766 677	120495	5-1-2	1.4 kg	1	pc(s)	173
766 678	126107	5-1-2	1.6 kg	1	pc(s)	173
766 703	080379	5-1-7	5.03 kg	1	pc(s)	161
766 704	069749	5-1-8	720 g	1	pc(s)	164
766 706	094307	5-1-0	800 g	1	pc(s)	41
766 710	094314	5-1-0	1.7 kg	1	pc(s)	41
766 720	094321	5-1-0	1.7 kg	1	pc(s)	41
766 888	125209	5-1-8	63 g	1	pc(s)	168
766 889	125193	5-1-8	172 g	1	pc(s)	168
766 913	051836	5-1-8	42 g	1	pc(s)	166
766 915	088207	5-1-8	220 g	1	pc(s)	166
766 916	106840	5-1-8	125 g	1	pc(s)	167
766 923	074590	5-1-8	84 g	1	pc(s)	166
766 924	094840	5-1-8	46 g	1	pc(s)	166
766 925	091672	5-1-8	10 g	1	pc(s)	166
766 927	097452	5-1-8	12 g	1	pc(s)	166
766 940	080485	5-1-8	145 g	1	pc(s)	167
766 941	080478	5-1-8	150 g	1	pc(s)	167
766 950	090668	5-1-1	339 g	1	pc(s)	168
766 960	109629	5-1-1	310 g	1	pc(s)	167
766 994	247062	5-1-7	3.31 kg	1	pc(s)	161
766 995	247147	5-1-7	4.38 kg	1	pc(s)	161
766 996	128170	5-1-7	4 kg	1	pc(s)	163
766 997	115699	5-1-7	2.39 kg	1	pc(s)	162
766 998	115286	5-1-7	3.36 kg	1	pc(s)	162
766 999	115279	5-1-7	3.32 kg	1	pc(s)	162

Part No.	GTIN*	PG	Weight	PU	SU	Page
767 101	069541	5-1-4	60 g	1	pc(s)	50
767 102	074064	5-1-4	62 g	1	pc(s)	50
767 106	073487	5-1-7	375 g	1	pc(s)	162
767 107	105577	5-1-7	880 g	1	pc(s)	162
767 110	070905	5-1-4	119 g	1	pc(s)	50
767 112	074361	5-1-4	150 g	1	pc(s)	51
767 122	074385	5-1-4	185 g	1	pc(s)	52
767 125	130319	5-1-1	1.26 kg	1	pc(s)	29
767 132	073005	5-1-4	640 g	1	pc(s)	53
767 133	073494	5-1-4	85 g	1	pc(s)	54
767 135	077720	5-1-4	85 g	1	pc(s)	54
767 136	081109	5-1-4	65 g	1	pc(s)	54
767 139	136953	5-1-4	820 g	1	pc(s)	53
767 150	139473	5-1-4	1.94 kg	1	pc(s)	52
767 403	094024	5-1-1	2.14 kg	1	pc(s)	34
767 406	094031	5-1-1	1.3 kg	1	pc(s)	34
767 410	135635	5-1-1	1.4 kg	1	pc(s)	34
767 413	128750	5-1-2	1.77 kg	1	pc(s)	35
767 415	081116	5-1-1	1.52 kg	1	pc(s)	35
767 416	084247	5-1-2	2.62 kg	1	pc(s)	35
767 418	094048	5-1-1	1.2 kg	1	pc(s)	34
767 420	093980	5-1-1	2.38 kg	1	pc(s)	34
767 428	094055	5-1-1	1.4 kg	1	pc(s)	34
767 430	093997	5-1-1	1.5 kg	1	pc(s)	34
767 433	094000	5-1-1	1.5 kg	1	pc(s)	34
767 438	135628	5-1-1	1.6 kg	1	pc(s)	34
767 500	105676	5-1-8	280 g	1	pc(s)	53
767 541	115712	5-1-9	1.2 kg	1	pc(s)	39
767 542	086616	5-1-9	5.35 kg	1	pc(s)	39
767 552	115736	5-1-9	2 kg	1	pc(s)	40
767 564	143784	5-1-9	464 g	1	pc(s)	173
767 565	143760	5-1-9	2.03 kg	1	pc(s)	38
767 571	124967	5-1-9	1.99 kg	1	pc(s)	38
767 572	124974	5-1-9	2.01 kg	1	pc(s)	38
767 573	134270	5-1-9	3.57 kg	1	pc(s)	38
767 574	125971	5-1-7	500 g	1	pc(s)	163
767 576	124998	5-1-9	214 g	1	pc(s)	174
767 577	125001	5-1-9	380 g	1	pc(s)	174
767 591	146785	5-1-9	809 g	1	pc(s)	173
767 592	146792	5-1-9	465 g	1	pc(s)	173
767 593	146808	5-1-9	471 g	1	pc(s)	173
767 637	155879	5-1-5	2.1 kg	1	pc(s)	43
767 639	155817	5-1-5	2.4 kg	1	pc(s)	43
767 645	156067	5-1-5	2.6 kg	1	pc(s)	43
767 647	156081	5-1-5	2.1 kg	1	pc(s)	43
767 652	157088	5-1-5	4.2 kg	1	pc(s)	42
767 656	157101	5-1-5	4.2 kg	1	pc(s)	42
767 666	157071	5-1-5	2.2 kg	1	pc(s)	43
767 671	156807	5-1-5	2.6 kg	1	pc(s)	43
767 701	071292	5-1-7	5.7 kg	1	pc(s)	161
767 703	070899	5-1-1	1.01 kg	1	pc(s)	28
767 706	070837	5-1-1	1.01 kg	1	pc(s)	28
767 707	131620	5-1-1	1.85 kg	1	pc(s)	28
767 710	070851	5-1-1	1.01 kg	1	pc(s)	28
767 711	070820	5-1-1	1.16 kg	1	pc(s)	28
767 712	074699	5-1-8	37 g	1	pc(s)	171
767 713	094925	5-1-8	44 g	1	pc(s)	171
767 719	131699	5-1-1	1.85 kg	1	pc(s)	28
767 720	070844	5-1-1	1.07 kg	1	pc(s)	28
767 721	070868	5-1-1	1.23 kg	1	pc(s)	28
767 722	113183	5-1-1	474 g	1	pc(s)	173
767 724	125902	5-1-1	4.22 kg	1	pc(s)	33
767 730	070813	5-1-1	1.13 kg	1	pc(s)	28
767 731	070875	5-1-1	1.29 kg	1	pc(s)	28
767 733	070882	5-1-1	1.29 kg	1	pc(s)	29
767 734	115149	5-1-1	420 g	1	pc(s)	173

Part No.	GTIN*	PG	Weight	PU	SU	Page
767 740	071063	5-1-1	1.45 kg	1	pc(s)	30
767 750	071070	5-1-1	1.51 kg	1	pc(s)	30
767 756	132047	5-1-1	1.95 kg	1	pc(s)	28
767 757	132054	5-1-1	1.13 kg	1	pc(s)	28
767 758	132030	5-1-1	1.16 kg	1	pc(s)	28
767 760	072947	5-1-8	177 g	1	pc(s)	172
767 761	072954	5-1-8	282 g	1	pc(s)	172
767 762	072961	5-1-8	353 g	1	pc(s)	172
767 763	072978	5-1-8	529 g	1	pc(s)	172
767 764	072114	5-1-8	506 g	1	pc(s)	172
767 766	091696	5-1-8	129 g	1	pc(s)	172
767 767	090378	5-1-8	440 g	1	pc(s)	172
767 768	113190	5-1-8	445 g	1	pc(s)	172
767 769	139831	5-1-1	1.23 kg	1	pc(s)	28
767 771	115118	5-1-8	600 g	1	pc(s)	172
767 773	135567	5-1-1	1.2 kg	1	pc(s)	28
767 774	131637	5-1-1	1.3 kg	1	pc(s)	29
767 776	096486	5-1-8	58 g	1	pc(s)	171
767 777	096493	5-1-8	46 g	1	pc(s)	171
767 778	094239	5-1-8	3 g	1	pc(s)	171
767 779	093942	5-1-8	3 g	1	pc(s)	171
767 798	160019	5-1-1	1 kg	1	pc(s)	28
767 903	134737	5-1-1	992 g	1	pc(s)	29
767 906	134744	5-1-1	992 g	1	pc(s)	29
767 910	134751	5-1-1	992 g	1	pc(s)	29
767 920	134768	5-1-1	1.1 kg	1	pc(s)	29
767 921	097360	5-1-1	1.65 kg	1	pc(s)	31
767 922	097384	5-1-1	1.07 kg	1	pc(s)	31
767 930	134775	5-1-1	1.17 kg	1	pc(s)	29
767 931	097377	5-1-1	1.08 kg	1	pc(s)	31
767 932	097391	5-1-1	1.07 kg	1	pc(s)	31
767 940	134829	5-1-1	1.38 kg	1	pc(s)	30
767 941	134782	5-1-1	1.17 kg	1	pc(s)	29
767 944	277731	5-1-1	1.38 kg	1	pc(s)	30
767 950	134836	5-1-1	1.44 kg	1	pc(s)	30
767 951	134799	5-1-1	1.26 kg	1	pc(s)	29
767 960	134812	5-1-1	1.32 kg	1	pc(s)	30
767 961	134805	5-1-1	1.32 kg	1	pc(s)	29
767 980	125926	5-1-1	5.98 kg	1	pc(s)	33
767 996	120181	5-1-7	2.3 kg	1	pc(s)	163
767 997	115682	5-1-7	2.42 kg	1	pc(s)	161
767 999	115262	5-1-7	3.4 kg	1	pc(s)	161
769 300	080867	5-4-2	2.8 kg	1	pc(s)	85
769 352	007345	5-5-2	4.8 kg	1	pc(s)	86
769 400	080881	5-4-2	3.68 kg	1	pc(s)	85
769 500	080904	5-4-2	4.68 kg	1	pc(s)	85
769 502	004542	5-5-2	5.6 kg	1	pc(s)	86
769 503	003996	5-4-2	1.64 kg	1	pc(s)	85
769 504	004559	5-4-2	1.6 kg	1	pc(s)	85
769 505	004566	5-4-2	1.46 kg	1	pc(s)	85
769 506	120938	5-5-2	6.5 kg	1	pc(s)	87
769 508	052383	5-5-2	4.5 kg	1	pc(s)	86
769 509	068230	5-1-8	358 g	1	pc(s)	164
769 515	157361	5-5-2	6.9 kg	1	pc(s)	87
769 516	157378	5-5-2	1.22 kg	1	pc(s)	175
769 517	157385	5-5-2	1.15 kg	1	pc(s)	180
769 518	157392	5-5-2	1.29 kg	1	pc(s)	180
769 519	157408	5-5-2	1.15 kg	1	pc(s)	180
769 701	242470	5-1-8	750 g	1	pc(s)	172
769 712	242517	5-1-1	5.23 kg	1	pc(s)	33
769 713	242487	5-1-1	413 g	1	pc(s)	173
770 001	011762	5-3-0	753 g	1	m	70
771 230	144392	5-7-1	1.05 kg	1	pc(s)	109

Part No. / GTIN* / PG / Weight / PU / SU / Page

Part No.	GTIN*	PG	Weight	PU	SU	Page
771 231	144408	5-7-1	1.05 kg	1	pc(s)	109
771 232	144415	5-7-1	1.05 kg	1	pc(s)	109
771 233	144422	5-7-1	1.05 kg	1	pc(s)	109
771 316	150393	5-4-1	418 g	1	pc(s)	72
772 310	057593	5-4-1	469 g	1	pc(s)	71
772 311	057586	5-4-1	482 g	1	pc(s)	71
772 312	054431	5-4-1	480 g	1	pc(s)	79
772 313	054448	5-4-1	400 g	1	pc(s)	79
772 314	080171	5-4-1	446 g	1	pc(s)	74
772 320	057432	5-4-1	785 g	1	pc(s)	71
772 321	057449	5-4-1	756 g	1	pc(s)	71
772 322	054455	5-4-1	747 g	1	pc(s)	79
772 323	054462	5-4-1	876 g	1	pc(s)	79
772 324	080188	5-4-1	719 g	1	pc(s)	74
772 330	069220	5-4-1	560 g	1	pc(s)	72
772 331	066304	5-4-1	566 g	1	pc(s)	72
772 340	057456	5-4-1	878 g	1	pc(s)	72
772 341	057425	5-4-1	902 g	1	pc(s)	72
773 034	114562	5-4-1	634 g	1	pc(s)	72
773 130	057722	5-4-1	801 g	1	pc(s)	72
773 234	114555	5-4-1	661 g	1	pc(s)	72
773 236	114579	5-4-1	714 g	1	pc(s)	74
773 251	005990	5-5-2	901 g	1	pc(s)	81
773 330	057760	5-4-1	830 g	1	pc(s)	72
773 331	069244	5-4-1	793 g	1	pc(s)	74
774 034	114586	5-4-1	662 g	1	pc(s)	79
774 130	057739	5-4-1	780 g	1	pc(s)	79
774 234	114593	5-4-1	772 g	1	pc(s)	79
774 251	006003	5-5-2	955 g	1	pc(s)	81
774 330	057715	5-4-1	941 g	1	pc(s)	79
774 434	114609	5-4-1	712 g	1	pc(s)	79
774 530	057746	5-4-1	700 g	1	pc(s)	79
775 621	102545	5-4-4	311 g	1	pc(s)	80
775 626	102569	5-4-4	343 g	1	pc(s)	80
775 631	102552	5-4-4	290 g	1	pc(s)	80
775 636	102576	5-4-4	350 g	1	pc(s)	80
781 000	151086	5-8-4	12 kg	1	pc(s)	140
781 010	148444	5-8-4	516 g	1	pc(s)	140
781 020	148451	5-8-4	1.36 kg	1	pc(s)	140
781 030	149113	5-8-4	1.4 kg	1	pc(s)	140
781 040	148390	5-8-4	894 g	1	pc(s)	142
781 060	148406	5-8-4	906 g	1	pc(s)	142
781 080	148284	5-8-4	270 g	1	pc(s)	142
781 085	148420	5-8-4	383 g	1	pc(s)	142
781 090	148413	5-8-4	230 g	1	pc(s)	142
781 100	148437	5-8-4	355 g	1	pc(s)	141
781 110	149120	5-8-4	105 g	1	pc(s)	141
781 130	152144	5-8-4	67 g	1	pc(s)	141
781 150	152175	5-8-4	94 g	1	pc(s)	141
781 170	152182	5-8-4	104 g	1	pc(s)	141
781 190	152199	5-8-4	167 g	1	pc(s)	141
781 220	151666	5-8-4	12.97 kg	1	pc(s)	141
781 230	153813	5-8-4	18.9 kg	1	pc(s)	140
782 000	239401	5-8-5	4.03 kg	1	pc(s)	138
782 010	230804	5-8-5	105 g	1	pc(s)	138
782 020	236509	5-8-5	10 g	1	Sa	138
782 022	236516	5-8-5	20 g	1	Sa	138
782 024	237193	5-8-5	36 g	1	Sa	138
782 028	237223	5-8-5	66 g	1	Sa	138
782 030	245792	5-8-5	1.19 kg	1	pc(s)	136

Part No.	GTIN*	PG	Weight	PU	SU	Page
782 031	245815	5-8-5	1.19 kg	1	pc(s)	136
782 040	245822	5-8-5	784 g	1	pc(s)	136
782 041	245839	5-8-5	784 g	1	pc(s)	136
782 050	245846	5-8-5	851 g	1	pc(s)	136
782 051	245853	5-8-5	851 g	1	pc(s)	136
782 060	245860	5-8-5	27 g	1	pc(s)	137
782 075	245877	5-8-5	35 g	1	pc(s)	137
782 077	273375	5-8-5	47 g	1	pc(s)	137
782 080	245884	5-8-5	66 g	1	pc(s)	137
782 081	273344	5-8-5	50 g	1	pc(s)	137
782 085	273443	5-8-5	53 g	1	pc(s)	137
782 090	245891	5-8-5	97 g	1	pc(s)	137
782 091	273474	5-8-5	60 g	1	pc(s)	137
782 098	274013	5-8-5	30 g	1	Sa	137
782 099	274006	5-8-5	45 g	1	Sa	137
784 032	018679	5-4-1	969 g	1	pc(s)	74
784 038	138452	5-4-1	1.01 kg	1	pc(s)	74
784 085	018686	5-4-1	872 g	1	pc(s)	74
784 201	006591	5-4-1	880 g	1	pc(s)	73
784 301	006553	5-4-1	1.7 kg	1	pc(s)	73
784 352	006072	5-5-2	806 g	1	pc(s)	76
784 401	006614	5-4-1	1.3 kg	1	pc(s)	73
784 461	118799	5-4-1	1.28 kg	1	pc(s)	75
784 463	118805	5-4-1	1.62 kg	1	pc(s)	75
784 480	054479	5-4-1	600 g	1	pc(s)	74
784 490	118812	5-4-1	533 g	3	pc(s)	75
784 501	006560	5-4-1	1.95 kg	1	pc(s)	73
784 755	054202	5-5-2	1.54 kg	1	pc(s)	76
784 756	230118	5-5-2	1.6 kg	1	pc(s)	76
785 100	087606	5-8-1	18 kg	1	pc(s)	120
785 111	070257	5-1-8	612 g	1	pc(s)	164
785 112	106550	5-8-1	17.8 kg	1	pc(s)	120
785 119	098213	5-8-1	700 g	1	pc(s)	123
785 213	090279	5-8-1	320 g	1	pc(s)	123
785 214	090286	5-8-1	320 g	1	pc(s)	123
785 215	090293	5-8-1	320 g	1	pc(s)	123
785 216	090309	5-8-1	320 g	1	pc(s)	123
785 217	090316	5-8-1	320 g	1	pc(s)	123
785 218	090323	5-8-1	320 g	1	pc(s)	123
785 219	090330	5-8-1	320 g	1	pc(s)	123
785 225	136434	5-8-1	140 g	1	pc(s)	123
785 310	092013	5-8-1	12.7 kg	1	pc(s)	123
785 325	106581	5-8-1	600 g	1	pc(s)	19
785 398	146532	5-8-1	156 g	1	pc(s)	124
785 399	146525	5-8-1	757 g	1	pc(s)	124
785 427	086838	5-8-2	300 g	1	pc(s)	125
785 442	152847	5-8-0	280 g	1	pc(s)	164
785 443	152854	5-8-0	520 g	1	pc(s)	164
785 455	088337	5-8-2	3.6 kg	1	pc(s)	128
785 456	086821	5-8-2	3.6 kg	1	m	128
785 457	087880	5-8-2	36 kg	1	pc(s)	128
785 458	115064	5-8-2	5.8 kg	1	m	128
785 459	115057	5-8-2	56 kg	1	pc(s)	128
785 465	088733	5-8-2	41.5 kg	1	pc(s)	127
785 466	088030	5-8-2	830 g	1	m	127
785 467	088740	5-8-2	38 kg	1	pc(s)	127
785 468	088757	5-8-2	1.64 kg	1	m	127
785 471	088764	5-8-2	20 kg	1	pc(s)	127
785 472	087057	5-8-2	1.95 kg	1	m	127
785 490	086890	5-8-2	240 g	1	pc(s)	126
785 491	088306	5-8-2	140 g	1	Pa	126
785 492	086883	5-8-2	140 g	1	Pa	126
785 493	088894	5-8-2	160 g	1	Pa	126
785 494	088320	5-8-2	160 g	1	Pa	126

Part No.	GTIN*	PG	Weight	PU	SU	Page
785 495	088900	5-8-2	290 g	1	Pa	126
785 496	088917	5-8-2	290 g	1	Pa	126
785 497	088924	5-8-2	660 g	1	pc(s)	126
785 502	087347	5-8-1	7.2 kg	1	pc(s)	119
785 592	087552	5-8-1	50 g	1	pc(s)	123
785 637	100701	5-8-2	14 g	10	pc(s)	23
785 638	086920	5-8-2	6 g	10	pc(s)	23
785 639	087019	5-8-2	15 g	10	pc(s)	23
785 640	087026	5-8-2	55 g	10	pc(s)	23
785 641	087897	5-8-2	55 g	10	pc(s)	23
785 642	087903	5-8-2	75 g	10	pc(s)	23
785 643	087910	5-8-2	80 g	10	pc(s)	23
785 644	087927	5-8-2	80 g	10	pc(s)	23
785 645	086869	5-8-2	420 g	1	pc(s)	125
785 646	089174	5-8-2	760 g	1	pc(s)	128
785 647	087040	5-8-2	73 g	1	pc(s)	128
785 648	088047	5-8-2	19 g	1	pc(s)	128
785 649	088054	5-8-2	2 g	1	pc(s)	128
785 650	106536	5-8-2	22 g	10	pc(s)	23
785 652	111479	5-8-2	9 g	10	pc(s)	23
785 730	274044	5-8-0	385 g	1	pc(s)	133
785 731	274075	5-8-0	385 g	1	pc(s)	133
785 732	274082	5-8-0	385 g	1	pc(s)	133
785 733	274099	5-8-0	385 g	1	pc(s)	133
785 734	274105	5-8-0	385 g	1	pc(s)	133
785 738	274716	5-8-0	387 g	1	Sa	133
785 739	274723	5-8-0	47 g	1	Sa	133
785 746	138414	5-8-0	379 g	1	pc(s)	134
785 747	138421	5-8-0	379 g	1	pc(s)	134
785 748	138438	5-8-0	388 g	1	pc(s)	134
785 749	138445	5-8-0	388 g	1	pc(s)	134
785 753	245143	5-8-0	83 g	1	pc(s)	134
785 755	152861	5-8-0	2.35 kg	1	pc(s)	132
785 756	152878	5-8-0	2.5 kg	1	pc(s)	132
785 757	152885	5-8-0	2.7 kg	1	pc(s)	132
785 758	245150	5-8-0	3.55 kg	1	pc(s)	132
785 761	274198	5-8-0	400 g	1	pc(s)	134
785 762	274211	5-8-0	375 g	1	pc(s)	134
785 763	274228	5-8-0	380 g	1	pc(s)	134
785 764	274235	5-8-0	415 g	1	pc(s)	134
785 765	274242	5-8-0	395 g	1	pc(s)	134
785 766	274259	5-8-0	390 g	1	pc(s)	134
785 769	152007	5-8-0	1.67 kg	1	pc(s)	132
785 770	149458	5-8-0	1.71 kg	1	pc(s)	132
785 771	149465	5-8-0	1.86 kg	1	pc(s)	132
785 772	149472	5-8-0	1.89 kg	1	pc(s)	132
785 773	149489	5-8-0	1.9 kg	1	pc(s)	132
785 774	149502	5-8-0	1.94 kg	1	pc(s)	132
785 775	149519	5-8-0	1.96 kg	1	pc(s)	132
785 779	151994	5-8-0	1.49 kg	1	pc(s)	132

Part No.	GTIN*	PG	Weight	PU	SU	Page
785 780	149526	5-8-0	1.54 kg	1	pc(s)	132
785 781	149533	5-8-0	1.63 kg	1	pc(s)	132
785 782	149540	5-8-0	1.66 kg	1	pc(s)	132
785 783	149557	5-8-0	1.76 kg	1	pc(s)	132
785 784	149564	5-8-0	1.8 kg	1	pc(s)	132
785 785	149571	5-8-0	2.04 kg	1	pc(s)	132
785 788	149588	5-8-0	112 g	1	pc(s)	132
785 789	149595	5-8-0	75 g	1	Pa	132
785 796	124912	5-8-0	163 g	1	Pa	130
785 797	124936	5-8-0	169 g	1	Pa	130
785 798	124943	5-8-0	180 g	1	Pa	130
785 799	124950	5-8-0	196 g	1	Pa	130
785 800	131019	5-8-0	202 g	1	Pa	130
785 808	242265	5-8-0	250 g	1	Pa	130
785 809	242296	5-8-0	270 g	1	Pa	130
785 810	242302	5-8-0	290 g	1	Pa	130
785 811	242319	5-8-0	310 g	1	Pa	130
785 812	242326	5-8-0	330 g	1	Pa	130
785 940	106253	5-8-1	10.85 kg	1	pc(s)	121
785 950	106383	5-8-1	27.3 kg	1	pc(s)	122
790 150	005365	5-4-1	450 g	1	pc(s)	80
790 160	018693	5-4-1	737 g	1	pc(s)	80
790 250	089495	5-3-1	193 g	1	pc(s)	62
790 251	089501	5-3-1	248 g	1	pc(s)	62
790 260	089518	5-3-1	180 g	1	pc(s)	62
790 261	089525	5-3-1	277 g	1	pc(s)	62
792 030	005853	5-4-1	610 g	1	pc(s)	80
792 190	068315	5-4-1	1.2 kg	1	pc(s)	80
792 450	051744	5-5-2	2.95 kg	1	pc(s)	81
792 451	230170	5-5-2	2.6 kg	1	pc(s)	81
792 453	054226	5-5-2	2.95 kg	1	pc(s)	81
792 454	230194	5-5-2	2.94 kg	1	pc(s)	81
795 001	011816	5-3-0	1 kg	1	m	70
795 040	077393	5-4-1	890 g	1	pc(s)	100
795 213	053243	5-4-1	114 g	1	pc(s)	100
795 214	051799	5-4-1	118 g	1	pc(s)	100
799 006	157347	5-1-8	4 kg	1	pc(s)	78
799 009	123298	5-4-4	5.1 kg	1	pc(s)	77
799 019	123304	5-4-4	328 g	1	pc(s)	77
799 100	237094	5-7-6	12.2 kg	1	pc(s)	150
923 110	092426	5-7-4	40 g	10	pc(s)	152
923 116	085978	5-7-4	42 g	10	pc(s)	152
923 117	093478	5-7-4	42 g	10	pc(s)	152
923 118	104969	5-7-4	38 g	10	pc(s)	153
923 119	104976	5-7-4	38 g	10	pc(s)	153

Variant No. / GTIN* / PG / Weight / PU / SU / Page

Part No.	GTIN*	PG	Weight	PU	SU	Page
V11E77B	163515	5-4-0	5.52 kg	1	pc(s)	68
V162LDM	162655	5-4-0	1.38 kg	1	pc(s)	102
V18JQHQ	163546	5-4-0	1.91 kg	1	pc(s)	68
V1KPXFR	165427	5-4-0	9.85 kg	1	pc(s)	89
V1RC3P2	163737	5-4-0	0.59 kg	1	pc(s)	105
V1TDM78	165311	5-4-0	4.66 kg	1	pc(s)	99
V27E2GP	163980	5-4-0	7.89 kg	1	pc(s)	69
V291ZZT	163997	5-4-0	9.39 kg	1	pc(s)	69
V2KWXUL	165588	5-4-0	10 kg	1	pc(s)	91
V2WPYVF	165601	5-4-0	8.06 kg	1	pc(s)	91
V3CM9FR	165687	5-4-0	8.32 kg	1	pc(s)	91
V3NC5HX	164031	5-4-0	3.44 kg	1	pc(s)	69
V3RQASE	163744	5-4-0	1.09 kg	1	pc(s)	105
V3WJMY	163676	5-4-0	3.65 kg	1	pc(s)	89
V43FCV8	165571	5-4-0	10 kg	1	pc(s)	91
V4RJ7A2	165526	5-4-0	5.76 kg	1	pc(s)	90
V4YPRGE	165243	5-4-0	1.14 kg	1	pc(s)	67
V5SVXPH	164727	5-4-0	6.33 kg	1	pc(s)	89
V5VN56Z	165465	5-4-0	4.81 kg	1	pc(s)	90
V6VE249	164185	5-4-0	10 kg	1	pc(s)	69
V7265NS	163355	5-4-0	1.04 kg	1	pc(s)	67
V76D5TH	164178	5-4-0	10 kg	1	pc(s)	69
V797FE6	163188	5-4-0	6.65 kg	1	pc(s)	67
V7GN8WU	162389	5-4-0	4.62 kg	1	pc(s)	69
V8115WA	163508	5-4-0	4.6 kg	1	pc(s)	68
V8D4AQ2	163485	5-4-0	6.04 kg	1	pc(s)	68
V8MCNWM	165441	5-4-0	10 kg	1	pc(s)	90
V8PPJEF	165649	5-4-0	10 kg	1	pc(s)	91
V8VF7CP	165458	5-4-0	6.29 kg	1	pc(s)	90
V93UVAP	164024	5-4-0	10 kg	1	pc(s)	69
V9JF26K	163294	5-4-0	2.09 kg	1	pc(s)	67
VA3926U	165403	5-4-0	6.81 kg	1	pc(s)	89
VAB3PJV	165410	5-4-0	7.8 kg	1	pc(s)	89
VABRSSE	164048	5-4-0	10 kg	1	pc(s)	69
VACNLP8	165540	5-4-0	7.51 kg	1	pc(s)	90
VAM7M6H	165267	5-4-0	4.25 kg	1	pc(s)	67
VB1DETL	165632	5-4-0	10 kg	1	pc(s)	91
VB53TC9	163270	5-4-0	8.23 kg	1	pc(s)	67
VCEY1U6	165397	5-4-0	5.33 kg	1	pc(s)	89
VCS8GYU	165304	5-4-0	4.96 kg	1	pc(s)	99
VD28FAD	165434	5-4-0	3.94 kg	1	pc(s)	89
VDXTBGF	164192	5-4-0	10 kg	1	pc(s)	69
VDZ2VDX	163843	5-4-0	1.38 kg	1	pc(s)	105
VE5E8FZ	165557	5-4-0	10 kg	1	pc(s)	91
VE5K3HM	162679	5-4-0	1.53 kg	1	pc(s)	102
VE5MT89	163522	5-4-0	1.24 kg	1	pc(s)	68
VE9HQHJ	165496	5-4-0	7.91 kg	1	pc(s)	90
VEH4JQY	163850	5-4-0	10 kg	1	pc(s)	102
VF33XR2	165564	5-4-0	10 kg	1	pc(s)	91
VFV1Z7K	163331	5-4-0	10 kg	1	pc(s)	67
VFZ17TJ	165663	5-4-0	10 kg	1	pc(s)	91
VG3V6T2	165298	5-4-0	7.32 kg	1	pc(s)	68
VG4GXHQ	165618	5-4-0	10 kg	1	pc(s)	91
VGCMAA5	162518	5-4-0	10 kg	1	pc(s)	69
VGJD2QX	165373	5-4-0	10 kg	1	pc(s)	89

Part No.	GTIN*	PG	Weight	PU	SU	Page
VGM214B	164017	5-4-0	10 kg	1	pc(s)	69
VGUVRRG	164000	5-4-0	1.67 kg	1	pc(s)	69
VH8QTCZ	163775	5-4-0	5.43 kg	1	pc(s)	108
VH95BZZ	165274	5-4-0	3.54 kg	1	pc(s)	68
VHBWUNH	163645	5-4-0	7.86 kg	1	pc(s)	89
VHV1NKR	164147	5-4-0	10 kg	1	pc(s)	69
VJ13VWW	162136	5-4-0	2.26 kg	1	pc(s)	67
VJ7VGZD	163553	5-4-0	2.67 kg	1	pc(s)	68
VKB2Q6J	163829	5-4-0	5.58 kg	1	pc(s)	108
VKZLVU3	165502	5-4-0	7.9 kg	1	pc(s)	90
VLB2F3G	163607	5-4-0	3.83 kg	1	pc(s)	68
VLL6JWS	163348	5-4-0	6.08 kg	1	pc(s)	67
VLUZZB9	165342	5-4-0	10 kg	1	pc(s)	100
VM2J753	165281	5-4-0	5.05 kg	1	pc(s)	68
VMBDCM1	165519	5-4-0	5.09 kg	1	pc(s)	90
VMLM2BZ	165489	5-4-0	6.47 kg	1	pc(s)	90
VMRSJWD	163805	5-4-0	1.1 kg	1	pc(s)	102
VMZDL8N	165625	5-4-0	10 kg	1	pc(s)	91
VN35H5D	163560	5-4-0	2.19 kg	1	pc(s)	68
VN63A91	163812	5-4-0	5.4 kg	1	pc(s)	108
VNC1S9W	163539	5-4-0	1.56 kg	1	pc(s)	68
VNYHZGF	165366	5-4-0	10 kg	1	pc(s)	100
VP6YV4T	162686	5-4-0	6.13 kg	1	pc(s)	108
VPH98CT	165472	5-4-0	6.29 kg	1	pc(s)	90
VPHPV2	163379	5-4-0	10 kg	1	pc(s)	67
VPZBBSL	163317	5-4-0	4 kg	1	pc(s)	67
VQ7PF5A	164154	5-4-0	10 kg	1	pc(s)	69
VQKTK4T	163768	5-4-0	5.23 kg	1	pc(s)	108
VQY44GL	165656	5-4-0	10 kg	1	pc(s)	91
VQYP8B2	163195	5-4-0	7.15 kg	1	pc(s)	89
VRAB9WB	165533	5-4-0	6.72 kg	1	pc(s)	90
VRDSN66	163669	5-4-0	3.29 kg	1	pc(s)	89
VRJG23Y	163300	5-4-0	2.93 kg	1	pc(s)	67
VRP3ZFL	165595	5-4-0	10 kg	1	pc(s)	91
VSB29AH	162662	5-4-0	0.8 kg	1	pc(s)	106
VSHDQZB	163836	5-4-0	1.71 kg	1	pc(s)	105
VSUN6NV	163782	5-4-0	1.56 kg	1	pc(s)	105
VSY71K4	163287	5-4-0	0.98 kg	1	pc(s)	67
VTCS2XV	163584	5-4-0	2.84 kg	1	pc(s)	68
VTJKEZU	165250	5-4-0	10 kg	1	pc(s)	67
VTSY9XH	163621	5-4-0	6.4 kg	1	pc(s)	89
VU2EWNF	165328	5-4-0	5.63 kg	1	pc(s)	99
VU8P6LE	165380	5-4-0	4.38 kg	1	pc(s)	89
VUKMT58	163799	5-4-0	1.25 kg	1	pc(s)	105
VUQ18JL	165359	5-4-0	10 kg	1	pc(s)	100
VU2656W	165335	5-4-0	10 kg	1	pc(s)	100
VVL7AKP	164130	5-4-0	10 kg	1	pc(s)	69
VVXDACJ	279032	5-4-0	5 kg	1	pc(s)	67
VWBDMP5	165670	5-4-0	10 kg	1	pc(s)	91
VYKJW2W	211407	5-4-0	4.42 kg	1	pc(s)	99
VZC3FST	163324	5-4-0	5.48 kg	1	pc(s)	67
VZKQZB5	164161	5-4-0	10 kg	1	pc(s)	69
VZL6TGH	163362	5-4-0	1.31 kg	1	pc(s)	67
VZPW9LG	163751	5-4-0	0.68 kg	1	pc(s)	102

Type	Part No.	Page	Type	Part No.	Page	Type	Part No.	Page	Type	Part No./Variant No.	Page
A STK	766 888	168	ASP A 110 420 L ZK	767 591	173	DSRT DD FS BAAA	782 050	136	EKS VI 2F KVS KK	745 903	101
AB 32 46 RW K L...	700 099	155	ASP A 110 420 S ZK	767 592	173	DSRT DD PS AACA	782 041	136	EKS VI 2F KVS SBK	745 901	101
AD ES SQ SK	765 001	83	ASP A 110 420 SL ZK	767 593	173	DSRT DD PS BACA	782 040	136	EKV FD K 70 8500AL	752 086	96
AD ES SQ SQL	765 006	83	ASPS 110 132 16.7 L	767 565	38	DSRT FC D8	782 099	137	EKV FD K 70 12000AL	752 126	96
AD HV STK SQ	766 313	168	ASPS 110 420 L	767 571	38	DSRT FS 10	782 080	137	EKV FD K H70 12000AL	752 121	96
AD M12 STK 30 350	766 352	180	ASPS 110 420 S	767 572	38	DSRT FS 10 1.5	782 081	137	EKV FD R 70 8500AL	752 087	96
AD ZK 25 200	766 055	180	ASPS 110 420 S L	767 573	38	DSRT FS 12 1.5	782 085	137	EKV FD R 70 12000AL	752 127	96
AD ZK STK 30 360	766 359	180	AT 50 30	785 442	164	DSRT FS 15	782 090	137	EKV FD R H70 12000AL	752 122	96
AH ISMTC	766 038	171	AT IHS NS	785 490	126	DSRT FS 15 1.5	782 091	137	EKV K 50 8500	751 086	96
AK 25 ESH STK SN7361	766 372	20	AT SPN II	766 543	44	DSRT FS 5	782 075	137	EKV K 50 12000	751 126	96
AK 36 SK STK 330	766 364	174	ATK 120 ...M NS	785 468	127	DSRT FS 8 1.5	782 077	137	EKV K H 50 12000	751 121	96
AK 36 SQ STK 360	766 365	174	ATK 120 25M NS	785 467	127	DSRT LWL 0.75	782 020	138	EKV LK 50 4000	750 042	97
AK AH ZK ISMTC	766 049	175	ATK 135 ...M NS	785 466	127	DSRT LWL 2.00	782 022	138	EKV LK UKH 70 4000AL	752 042	97
AK SK24 SK12	763 712	21	ATK 135 50M NS	785 465	127	DSRT LWL 4.00	782 024	138	EKV R 50 8500	751 087	96
AK SQL STK 365	766 465	174	ATN 140 ...M NS	785 472	127	DSRT LWL 8.00	782 028	138	EKV R 50 12000	751 127	96
APA B	785 788	132	ATN 140 10M NS	785 471	127	DSRT LWL U	782 010	138	EKV R H 50 12000	751 122	96
APA KP	785 789	132				DSRT PS	782 060	137	EKV ÜGK MB	745 107	110
APC 48 50	785 755	132	BEV 2XUKH 70 8500AL	752 192	98	DSRT QD	782 000	138	EKV ÜGK MB S	745 105	110
APC 52 54	785 756	132	BEV BM HZ BDW K	751 193	97	DSRT SR D8 L20	782 098	137	EKV UK 50 4000	750 041	97
APC 56 58	785 757	132	BEV BM HZ BDW R	751 197	98				EKV UKQ UKH70 4000AL	752 041	97
APC 60 62	785 758	132	BEV MF LTE	751 192	98	EAB RN 16 FS	790 150	80	EKV1+0 16 V4YPRGE	67
APG 8	785 796	130	BEV MF SE K	751 191	97	EAB RN 16 SKN	790 160	80	EKV1+0 25 VSY71K4	67
APG 8 L	785 808	130	BEV MF SE R	751 196	98	EAP 2 25 KKH HG	728 501	64	EKV1+0 35 V9JF26K	67
APG 9	785 797	130	BEV OL NPF K	750 210	92	EAP 2 25 MA US OL	728 502	64	EKV1+0 50 VRJG23Y	67
APG 9 L	785 809	130	BEV OL NPF PKW K	750 196	92	EAP 25 SIT US OL	728 503	64	EKV1+0 70 VPZBBSL	67
APG 10	785 798	130	BEV OL NPF PKW R	750 216	92	EAPA 3 KFP 20 B13	728 522	64	EKV1+0 70 VVXDACJ	67
APG 10 L	785 810	130	BEV OL NPF R	750 218	92	EAPA 3 KFP 20 KKH	728 620	63	EKV1+0 95 VZC3FST	67
APG 11	785 799	130	BEV OL PF K	750 211	93	EAPA 3 KFP 25 B13	728 526	64	EKV1+0 120 V797FE6	67
APG 11 L	785 811	130	BEV OL PF PKW K	750 200	94	EAPA 3 KFP 25 KKH	728 625	63	EKV1+0 150 VB53TC9	67
APG 12	785 800	130	BEV OL PF PKW R	750 217	94	EAPA 3 RN 16 B13	728 506	64	EKV1+1 16 VE5E8FZ	91
APG 12 L	785 812	130	BEV OL PF R	750 219	93	EAPA 3 RN 16 EAB	728 516	64	EKV1+1 16 VMZDL8N	91
APJ 46	785 769	132	BEV OL PF V2 K	750 214	93	EAS EK FM 12	775 621	80	EKV1+1 25 VB1DETL	91
APJ 48	785 770	132	BEV OL PF V2 R	750 221	93	EAS EK FM 16	775 631	80	EKV1+1 25 VF33XR2	91
APJ 50	785 771	132	BEV SVUL	750 213	95	EAS EK FS 12	775 626	80	EKV1+1 35 V43FCV8	91
APJ 52	785 772	132	BEV UKH K 70 8500AL	752 191	97	EAS EK FS 16	775 636	80	EKV1+1 35 V8PPJEF	91
APJ 54	785 773	132	BEV UKH K 70 12000AL	752 193	97	EB 9V AL	767 713	171	EKV1+1 50 V2KWXUL	91
APJ 56	785 774	132	BEV UKH R 70 8500AL	752 196	98	EB 9V LI	767 712	171	EKV1+1 50 VQY44GL	91
APJ 58	785 775	132	BEV UKH R 70 12000AL	752 197	98	EFK FL30 SKN	792 030	80	EKV1+1 70 VFZ17TJ	91
APS 12C FS	785 749	134	BEV US OL ST	750 212	94	EFK FL40 SKN	792 190	80	EKV1+1 70 VRP32FL	91
APS 12C SC	785 747	134	BEV WHA ZVA	750 215	95	EFP 16 RN M12	790 250	62	EKV1+1 95 V2WPYVF	91
APS CL2 FS	785 748	134				EFP 16 RN M12 35 SSM	790 251	62	EKV1+1 95 VVWBDMP5	91
APS CL2 SC	785 746	134	DARC HV STG	781 110	141	EFP 16 RN M16	790 260	62	EKV1+1 120 V3CM9FR	91
APS T 12C FS	785 765	134	DARC KSP	781 020	140	EFP 16 RN M16 45 SSM	790 261	62	EKV1+1 120 VG4GXHQ	91
APS T 12C SC	785 762	134	DARC KST	781 030	140	EFS L 127	767 576	174	EKV2 50 KKH 600 1800	751 150	97
APS T 20C FS	785 766	134	DARC LSDH	781 100	141	EFS S 167	767 577	174	EKV2+0 16 G V7265NS	67
APS T 20C SC	785 763	134	DARC LSH M10	781 080	142	EG 00 4A VI	745 922	103	EKV2+0 25 G VZL6TGH	67
APS T CL2 FS	785 764	134	DARC LSH SB	781 090	142	EG SK STK 400	745 415	112	EKV2+0 35 G VPHPV2	67
APS T CL2 SC	785 761	134	DARC LSH WB	781 085	142	EG SQ STK 400	745 414	112	EKV2+0 50 G VJ13VWW	67
APT 46	785 779	132	DARC LSHS L 940	781 040	142	EG TI EKV	745 400	107	EKV2+0 70 G VTJKEZU	67
APT 48	785 780	132	DARC LSHS R 940	781 060	142	EH1 PK FV ZK	784 461	75	EKV2+0 95 G VAM7M6H	67
APT 50	785 781	132	DARC PK KSP	781 230	140	EH3 PK FV SQL	784 463	75	EKV2+0 120 G VV1Z7K	67
APT 52	785 782	132	DARC STG	781 000	140	EHH BEV OL	740 124	98	EKV2+0 150 G VLL6JWS	67
APT 54	785 783	132	DARC TK	781 220	141	EK FL20 FS	745 502	107	EKV3 16TI EK VSB29AH	106
APT 56	785 784	132	DARC TRM	781 010	140	EK I FL20 DGF	745 602	107	EKV3 16TI HK V3RQASE	105
APT 58	785 785	132	DARC VL 10 500	781 170	141	EKS 50 BEV 12M	751 120	98	EKV3 16VI EK VZVP9LG	102
AR STK	766 889	168	DARC VL 10 1000	781 190	141	EKS 50 BEV 13M	751 130	98	EKV3 25BS ZK VQKTK4T	108
ARS 65 40	785 443	164	DARC VL 4 1000	781 130	141	EKS 50 BEV 14M	751 140	98	EKV3 25IS ZK VH8QTCZ	108
AS SCHR M12 55	705 500	63	DARC VL 4 1500	781 150	141	EKS 50 BEV 4M	751 040	98	EKV3 25TI DG VSUN6NV	105
AS SCHR M12 M12 40	705 504	63	DGF EKV VI	745 921	103	EKS 50 BEV 8.5M	751 085	98	EKV3 25TI HK VUKMT58	105
AS SCHR M16 55 M12	705 510	63	DP 40 40 B13 AL	525 001	170	EKS B10.5 70 4000AL	752 040	98	EKV3 25VI DG V162LDM	102
AS SCHR M16 65	750 500	63	DP 50 50 B17 AL	525 002	170	EKS B10.5 70 8500AL	752 085	98	EKV3 25VI EK VMRSJWD	102
AS SCHW M12	336 020	62	DR PHV	767 778	171	EKS B10.5 70 12000AL	752 120	98	EKV3 35BS ZK VN63A91	108
AS SCHW M12 25	705 501	62	DR PS PHE3	767 779	171	EKS B10.5 70 13000AL	752 130	98	EKV3 35IS ZK VKB2Q6J	108
AS SCHW M16	336 025	62	DSRT DD CPS AACA	782 031	136	EKS B10.5 70 14000AL	752 140	98	EKV3 35TI DG VSHDQZB	105
AS SCHW M16 30	755 501	62	DSRT DD CPS BACA	782 030	136	EKS TI 2F KVS SBK	745 500	104	EKV3 35TI HK VDZ2VDX	105
ASP A 110 132 16.7 L	767 564	173	DSRT DD FS AAAA	782 051	136	EKS TI KVS SBK	766 302	104	EKV3 35VI DG VE5K3HM	102

Type	Part No./Variant No.	Page	Type	Part No.	Page	Type	Part No.	Page	Type	Part No.	Page
EKV3 35VI EK VEH4JQY	102	EP NH1 3 VI TA	745 910	103	FWD 35 P NS	785 592	123	IS SK12 HK 1720	763 710	21
EKV3 50IS ZK VP6YV4T	108	EP NH4A TI M10	745 016	106				IS ZK STK 670	766 368	176
EKV3 NH00 TI V1RC3P2	105	EP NH4A VI TA	745 915	103	GL 3.5V 0.2A E10	766 605	171	IS ZK STK HS 670	766 369	176
EKV3+0 16 G VESMT89	68	ERO BSP ASSM10 1000 STTZN						ISMTC N 36 ZK 10600	766 037	177
EKV3+0 25 G VNC1S9W	68		644 000	77	H AB 32 46 K	700 098	155	ISN 123 SK STK 2500	766 222	11
EKV3+0 35 G V18JHQH	68	ES 3P FL ER	799 009	77	H STK 43 800	766 120	179	ISN 123 SQ STK 2500	766 332	12
EKV3+0 50 G VJ7VGZD	68	ES SK 1000	761 010	82	HG ZK 230	766 393	19	ISN 25 STK 900SN7360	766 371	20
EKV3+0 50 R VN35H5D	68	ES SK 1500	761 015	82	HISC 1600	785 310	123	ISN 36 SK 1000	766 210	10
EKV3+0 70 G VH95BZZ	68	ES SK STK 1000	761 001	83	HK 8 NS	785 648	128	ISN 36 SK 1500	766 215	10
EKV3+0 70 R VTC52XV	68	ES SK STK 2000	761 003	83	HOEL 36 20 1100	785 399	124	ISN 36 SK STK 1000	766 111	11
EKV3+0 95 G VM2J7S3	68	ES SQ 1000	761 011	82	HSA 194 110 420 STK	767 541	39	ISN 36 SQ 1000	766 211	10
EKV3+0 95 R VLB2F3G	68	ES SQ 1500	761 016	82	HSA194 110 420 16.7	767 542	39	ISN 36 SQ 1500	766 216	10
EKV3+0 120 G V8D4AQ2	68	ES SQ STK 1000	761 002	83	HSA205 U 1 420 STK	767 552	40	ISN 36 SQ STK 1000	766 310	11
EKV3+0 120 R V8115VA	68	ES SQ STK 2000	761 004	83	HV 3HH	700 015	169	ISN 36 STK 30 1280	766 367	177
EKV3+0 150 G VG3V6T2	68	ES SQL ALSTK 1035	769 516	175	HV 3HH ET	700 005	169	ISN 36 STK 43 1280	766 468	177
EKV3+0 150 R V11E77B	68	ES SQL STK 43 1045	766 074	175	HV 3HH SZ	700 014	169	ISN 36 STK 930SN7688	766 362	177
EKV3+1 16 G V8MCNWM	90	ES YM2 16	716 001	70	HV 3HH SZ ET	700 004	169	ISO M12 STK 30SN7563	766 116	178
EKV3+1 16 G VGJ2QX	89	ES YM2 25	725 001	70	HV ALSTK 1035	769 517	180	ISP 36 PVC A1...	763 211	115
EKV3+1 25 G V8VF7CP	90	ES YM2 35	735 001	70	HV ALSTK AK RW 1035	769 519	180	ISP 36 PVC A2...	763 221	115
EKV3+1 25 G VRDSN66	89	ES YM2 50	750 001	70	HV ALSTK RW 1035	769 518	180	ISP 36 PVC A3...	763 231	115
EKV3+1 35 G V3WJMY	89	ES YM2 70	770 001	70	HV EKV ES30	700 000	169	ISP 36 PVC A4...	763 241	115
EKV3+1 35 G V5VN56Z	90	ES YM2 95	795 001	70	HV EKV ES30 1500	700 003	169	ISU STK STK 30SN7564	766 117	178
EKV3+1 50 G VPH98CT	90	ES YM2 120	712 001	70	HV EKV ES40	700 002	169	ISV 36 STK 30 1280	766 366	179
EKV3+1 50 G VU8P6LE	89	ES YM2 150	715 001	70	HV P ST D24	700 006	169	ISV 36 STK 30 910	766 356	179
EKV3+1 50 R VD28FAD	89	ESE E27 KBI M10	745 203	107	HV P ST D30	700 007	169	ISV SK12 1060	763 711	21
EKV3+1 50 R VMBDCM1	90	ESE E27 TI M10	745 201	106	HV P ST D40 45	700 008	169	IT M12 STK 30 1150	766 115	178
EKV3+1 70 G VCEY1U6	89	ESE E33 KBI M10	745 204	107	HV STK 30 710	766 335	179	IT ZK30 STK 30 360	766 358	178
EKV3+1 70 G VMLM2BZ	90	ESE E33 TI M10	745 202	106	HV STK 43 910	766 456	179			
EKV3+1 70 R V4RJ7A2	90	ESH U 1000 S B	785 733	133	HV STK 43 975	766 077	179	KFP 20 M10	754 205	59
EKV3+1 70 R VQYP8B2	89	ESH U 1000 S O	785 732	133	HV STK 43 1045	766 076	179	KFP 20 M12	754 200	59
EKV3+1 95 G VA3926U	89	ESH U 1000 S R	785 734	133	HV STK 43 1280	766 466	179	KFP 20 M12 35 SSM	754 235	59
EKV3+1 95 G VE9HQHJ	90	ESH U 1000 S W	785 731	133	HV STK 43 2350	766 073	179	KFP 20 M16	754 600	59
EKV3+1 95 R V5SVXPH	89	ESH U 1000 S Y	785 730	133	HV STK RW 43 975	766 079	179	KFP 20 M16 45 SSM	754 645	59
EKV3+1 95 R VRAB9WB	90	ESP HVS 1500	799 006	78	HV STK RW 43 1045	766 078	179	KFP 20 RL 10	720 010	60
EKV3+1 120 G VAB3PJV	89	ESS 3P M10 FM	799 019	77	HVTC STK 4100 SN7359	766 469	20	KFP 20 RL 12	720 012	60
EKV3+1 120 G VKZLVU3	90	EST ES 1500	769 505	85				KFP 20 RL 14	720 014	60
EKV3+1 120 R VACNLP8	90	EST KS SQL 1500	769 503	85	IHS 0 M 10 NS	785 494	126	KFP 20 RL 16	720 016	60
EKV3+1 120 R VTSY9XH	89	EST SK STK 920	761 070	83	IHS 0 M 9 NS	785 493	126	KFP 20 RL 18	720 018	60
EKV3+1 150 G V1KPXFR	89	EST SQ STK 920	761 075	83	IHS 00 M 10 NS	785 492	126	KFP 20 RL 20	720 020	60
EKV3+1 150 R VHBWUNH	89	EST SQL RW 4855 TA	769 515	87	IHS 00 M 9 NS	785 491	126	KFP 20 S AL 12	706 300	59
EKV4U0 120 G V27E2GP	69	EST SQL RW 4915 TA	769 506	87	IHS 00 RC 10 NS	785 496	126	KFP 20 W45 M12	706 200	61
EKV4U0 150 G V291ZZT	69	EST ZS 1500	769 504	85	IHS 00 RC 9 NS	785 495	126	KFP 20 W45 M12 35SSM	706 235	60
EKV4U0 16 G VGVVRRG	69	ESTC SQL 4000	769 400	85	IMG SAN 1M ..M	785 458	128	KFP 20 W45 M16	706 600	61
EKV4U0 25 G VGM214B	69	ESTC SQL 5000	769 500	85	IMG SAN 1M 10M	785 459	128	KFP 20 W45 M16 45SSM	706 645	60
EKV4U0 35 G V93UVAP	69	ESTC SQL H RW 5000	769 508	86	IMG SI ..M NS	785 456	128	KFP 20 W90 M12	707 200	61
EKV4U0 50 G V3NC5HX	69	ESTC SQL RW 3500	769 352	86	IMG SI 10M NS	785 457	128	KFP 20 W90 M12 35SSM	707 235	61
EKV4U0 70 G V7GN8WU	69	ESTC SQL RW 5000	769 502	86	IMG SI 1M NS	785 455	128	KFP 20 W90 M16	707 600	61
EKV4U0 95 G VABRSSE	69	ESTC SQL STK 3000	769 300	85	IS 123 SK STK 2000	766 122	11	KFP 20 W90 M16 45SSM	707 645	61
EKV5+0 16 G VQ7PF5A	69	EV EH 1725 EK	758 015	158	IS 123 SQ STK 2000	766 322	11	KFP 25 M12	755 200	59
EKV5+0 25 G VZKQZB5	69	EV EHB 1600 SN7114	758 028	159	IS 25 ZK 2885	766 048	176	KFP 25 M12 25 SSM	755 225	59
EKV5+0 35 G V76D5TH	69	EV TES 465 EK	758 020	157	IS 25 ZK RK 3160	766 340	22	KFP 25 M12 35 SKM	755 627	60
EKV5+0 50 G V6VE249	69	EV TES 465 EZ	758 021	157	IS 36 SK 1000	766 001	10	KFP 25 M12 45 SSM	755 245	59
EKV5+0 70 G VDXTBGF	69	EV TES 465 KS10	758 022	157	IS 36 SK 1500	766 002	10	KFP 25 M16	755 600	59
EKV5+0 95 G VGCMAA5	69	EV TES STK 1500 KS	758 025	159	IS 36 SK STK 1000	766 100	11	KFP 25 M16 25	755 636	60
EKV5+0 120 G VVL7AKP	69	EV TS 1470 SN7685	758 031	159	IS 36 SQ 1000	766 311	10	KFP 25 M16 25 SKM	755 626	60
EKV5+0 150 G VHV1NKR	69	EV TS 2000 EK	758 001	158	IS 36 SQ 1500	766 315	10	KFP 25 M16 45 SKM	755 646	60
EL M8 G PHE	766 924	166	EV TS 2000 EZ	758 003	158	IS 36 SQ STK 1000	766 301	11	KFP 25 M16 45 SSM	755 645	59
EL M8 H PHE	766 923	166				IS 36 STK 30 1280	766 363	13	KFP 25 RL 10	725 010	60
EL M8 MAG PHE PHV	766 915	166	FD 60 MS SN7271	785 225	123	IS 36 STK 30 1280	766 363	177	KFP 25 RL 12	725 012	60
EL M8 S PHE PHV	766 925	166	FEK 4 15 TS FSQL	784 755	76	IS 36 STK 43 1280	766 463	13	KFP 25 RL 14	725 014	60
EL M8 SZ PHE PHV	766 913	166	FEK4 15 TS FSQL AB29	784 756	76	IS 36 STK 43 1280	766 463	177	KFP 25 RL 16	725 016	60
EL M8 V PHE PHV	766 927	166	FR A12 V2A	524 912	170	IS 36 ZK STK 1300	785 325	19	KFP 25 RL 18	725 018	60
EP NH00 TI M10	745 302	106	FR A16 V2A	524 913	170	IS M12 AK 635	766 328	176	KFP 25 RL 20	725 020	60
EP NH00 VI TA	745 905	103	FRS ZK MS	785 940	121	IS M12 STK 30 1060	766 075	177	KFP 25 S AL 12	756 300	59
EP NH1 3 TI GL M10	745 017	106	FSG PHE	767 776	171	IS M12 STK 30 720	766 072	177	KFP 25 W45 M12	756 200	61
EP NH1 3 TI M10	745 018	106	FSG PHG2 PHV	767 777	171	IS M12 STK 640	766 331	176	KFP 25 W45 M12 45SSM	756 245	60

Type	Part No./Variant No.	Page	Type	Part No.	Page	Type	Part No.	Page	Type	Part No.	Page
KFP 25 W45 M16	756 600	61	MZ 1.5 IEC LR6 AL	766 618	171	PHE3 PK6 20 S SB ZK	767 921	31	RSI 51	785 218	123
KFP 25 W45 M16 45SSM	756 645	60	MZ 1.5V L91 FR6 LI 4	766 611	171	PHE3 U 3 30 S	767 733	29	RSI 58	785 219	123
KFP 25 W90 M12	757 200	61				PHE3 U 3 30 S ZK	767 960	30	RST 36 1000	766 040	15
KFP 25 W90 M12 45SSM	757 245	61	NHS AG 00 3 NS	785 645	125	PHE3 U 3.3 33 SN7108	767 774	29	RST 36 1500	766 041	15
KFP 25 W90 M16	757 600	61				PHE3 U 6 36 S SN7728	767 944	30	RST 36 2000	766 042	15
KFP 25 W90 M16 45SSM	757 645	61	OEK 12 NS	785 649	128	PHE3S 20 S ZK	767 724	33			
KK 35 NS	785 647	128				PHE3S60 110S CSN7774	769 712	33	S60 PS PHE 285	767 760	172
KK 56 41 17 EK HK	745 953	162	PAP 2 M12 SSM B13	728 312	75	PHE3S2 60 110 S	767 980	33	S61 PS PHE 435	767 761	172
KK 56 41 17 EK VI TI	745 952	102	PAP 3 M12 SSM B13 RB	728 313	75	PHEG1.FD P SN7544	767 652	42	S62 PS PHE 620	767 762	172
KK M8 0 24 SK 10	745 508	107	PAS EK SQ 16	771 316	72	PHEG1.FD P SN7647	767 656	42	S63 PS PHE 780	767 763	172
KK TA 0 24 SK10	745 503	103	PFP ... AL 60 82	731 011	65	PHEG1.S P SN7401	767 666	43	S63 PS PHE 8CK	767 768	172
KKH 20 D SK	772 330	72	PFP ... AL 60 98	731 013	65	PHEG2 P SN7194	767 637	43	S64 PS PHE 880	767 764	172
KKH 20 D SQ	772 331	72	PFP ... AL 60 126	731 015	65	PHEG2 P SN7259	767 645	43	S65 M PS PHE 905	767 767	172
KKH 20 FS	772 312	79	PFP ... CU 60 82	731 027	65	PHEG2 P SN7346	767 639	43	S66 PS PHE 880	767 771	172
KKH 20 HG	772 313	79	PFP ... CU 60 98	731 037	65	PHEG2 P SN7552	767 647	43	S66PS PHE880 C SN7771	769 701	172
KKH 20 SK	772 310	71	PHE 3 10 S	767 410	34	PHEG2.P SN7517	767 671	43	SA KLFP SK	795 214	100
KKH 20 SQ	772 311	71	PHE 3 20 S FU 1P	767 416	35	PHG2 6	766 706	41	SA KLFP SQ	795 213	100
KKH 20 SQL	772 314	74	PHE 3 S	767 403	34	PHG2 10	766 710	41	SAG DCA A LRM	767 112	51
KKH 25 D SK	772 340	72	PHE 6 20 S	767 420	34	PHG2 20	766 720	41	SAG DCA P HR GA	767 101	50
KKH 25 D SQ	772 341	72	PHE 6 20 S 16.7 1P	767 415	35	PHSP NS	785 497	126	SAG DCA P LRM GA	767 102	50
KKH 25 FS	772 322	79	PHE 6 S	767 406	34	PHV 3 36 STK	759 300	46	SAK PFE KN	792 450	81
KKH 25 HG	772 323	79	PHE 10 S	767 418	34	PHV1P 6 12	759 706	48	SAK PFE KN AB29	792 451	81
KKH 25 SK	772 320	71	PHE 15 16.7 4T TA	766 616	36	PHV1P 10 20	759 712	48	SAK PFE RA	792 453	81
KKH 25 SQ	772 321	71	PHE 15 16.7 6T TA	766 617	36	PHV1P 20 36	759 736	48	SAK PFE RA AB29	792 454	81
KKH 25 SQL	772 324	74	PHE 15 16.7 BEL STK	767 413	35	PHV1P U 5 36	759 716	48	SB ESH U 1000	785 739	133
KKL 26 22 5	767 106	162	PHE 15 30 S	767 430	34	PK FV 4 25	784 490	75	SBKL EKS TI KVS	766 300	161
KKL 92 28 12	766 994	161	PHE 20 S	767 428	34	PS 10 12 PHV	759 610	46	SBKL EKS TI KVS 2F	766 298	161
KKL 127 28 12	766 995	161	PHE 30 S	767 438	34	PS 10 12 PHV D11	759 111	47	SBKL EKS VI KVS	745 900	161
KKL DCA	767 107	162	PHE A 15 16.7	766 677	173	PS 10 12 PHV W90	759 611	47	SCH A13 V2A	525 912	170
KKL EKS VI KVS	745 902	102	PHE PK 15 16.7	766 678	173	PS 10 17.5 PHV	759 615	46	SCH A17 V2A	525 916	170
KKL EKV ÜGK MB	745 106	110	PHE U 3 30 S	767 433	34	PS 15 24 PHV	759 620	46	SCS 123 STK 2000	763 180	14
KKL PHE	766 997	162	PHE3 3 10 S	767 711	28	PS 15 24 PHV L880	759 621	47	SCS 36 1000	763 610	14
KKL PHE L	766 999	162	PHE3 3 10 S ZK	767 941	29	PS 15 24 PHV W90	759 622	47	SCS 36 1500	763 611	14
KKL PHE3	767 997	161	PHE3 3 S	767 703	28	PS 20 24 PHV D11	759 121	47	SCS 36 2000	763 612	14
KKL PHE3 60 110	766 998	162	PHE3 3 S ZK	767 903	29	PS 3 3.6 PHV	759 603	46	SCS 36 STK 1000	763 100	14
KKL PHE3 L	767 999	161	PHE3 3.3 S SN7130	767 798	28	PS 3 3.6 PHV W90	759 604	47	SCS 72 1500	763 615	14
KKL PHV	759 999	162	PHE3 3.3 11 S SN7127	767 758	28	PS 5 7.2 PHV	759 605	46	SCS 72 2000	763 620	14
KKL PHV1	759 998	162	PHE3 6 20 S	767 721	28	PS 5 7.2 PHV W90	759 608	47	SCS 72 STK 1500	763 150	14
KKL PK PHE3 L	766 036	162	PHE3 6 20 S ZK	767 951	29	PS DCA HR LRM	767 150	52	SCSN 123 STK 2800	763 181	15
KLFP M12 KSS	795 040	100	PHE3 6 20 SL	767 740	30	PS PHE 15 16.7	766 619	173	SCSN 36 1000	763 510	14
KLT 23 16 4	767 500	53	PHE3 6 20 SL ZK	767 940	30	PSK 10 32 SQL	784 032	74	SCSN 36 1500	763 511	14
KLT 101 30 10	767 996	163	PHE3 6 S	767 706	28	PSK 10 32 SQL SB	784 038	74	SCSN 36 STK 1000	763 111	14
KLT 104 9	767 574	163	PHE3 6 S ZK	767 906	29	PSK 10 65 SQL	784 301	73	SCSN 36 STK 2000	763 112	14
KLT 121 25 16	766 601	163	PHE3 6.6 S SN7101	767 707	28	PSK 10 65 SQL EH	784 501	73	SDS 1	923 110	152
KLT 133 34 10	766 996	163	PHE3 6.6 22 SN7197	767 769	28	PSK 10 85 SQL	784 085	74	SDS 2	923 117	152
KLT 160 17	766 614	163	PHE3 10 30 S	767 731	28	PSK 4 30 SQL	784 201	73	SDS 3	923 116	152
KLT 247 10 22	766 602	163	PHE3 10 30 S ZK	767 961	29	PSK 4 30 SQL EH	784 401	73	SDS 4	923 118	153
KR ESH U 1000	785 738	133	PHE3 10 30 SL	767 750	30	PSK FV 4 30 SQL	784 480	74	SDS 5	923 119	153
KS SG BLS 8	766 105	171	PHE3 10 30 SL ZK	767 950	30	PSO M8 PHE	766 916	167	SE E14	785 639	23
KS60 8SK A VUZ656W	99	PHE3 10 S	767 710	28	PSO M8 PHE L800	766 960	167	SE E18	785 650	23
KS60 8SK C VYKJW2W	99	PHE3 10 S ZK	767 910	29	PSO M8 W25 PHE	766 940	167	SE E27 E33	785 640	23
KS60 8SQ A VUQ18JL	100	PHE3 11 S SN7116	767 719	28	PSO M8 W45 PHE	766 941	167	SE NH0	785 642	23
KS60 8SQ C V1TDM78	99	PHE3 11 33 S SN7264	767 773	28	PSO M8 W90 PHE	766 950	168	SE NH00	785 641	23
KS60 12SK A VLUZB9	100	PHE3 20 S	767 720	28	PSS DII	745 109	111	SE NH1	785 643	23
KS60 12SK C VCS8GYU	99	PHE3 20 S ZK	767 920	29	PV DCA PC LRM	767 132	53	SE NH2 3	785 644	23
KS60 12SQ A VNYHZGF	100	PHE3 22 S SN7128	767 756	28	PV DCA PC LRM T	767 139	53	SE REG 1TE	785 638	23
KS60 12SQ C VU2EWNF	99	PHE3 25 S 50 1P	767 125	29				SE REG 2TE	785 652	23
			PHE3 30 S	767 730	28				SE REG 3TE	785 637	23
L71 PS PHE 185	767 766	172	PHE3 30 S ZK	767 930	29	RBK 35 SQ	715 312	72	SET DIGIK	766 390	18
LK 4 40 TS SQL	784 352	76	PHE3 33 S SN7129	767 757	28	RED E27 E14 ÜGK MB	745 108	111	SKL 92 16 10	766 703	161
			PHE3 A 20 SL ZK	767 722	173	RK 230 100 AS25	766 056	175	SKL 95 21 10	767 701	161
MA DCA HR LRM	767 133	54	PHE3 A 60 110 S	767 734	173	RP 250 115 20	766 057	175	SKL 95 21 10 V2	759 003	161
MA DCA LR LRM	767 136	54	PHE3A60110SITCSN7772	769 713	173	RSI 32	785 213	123	SKL 116 16 10	766 603	161
MA DCA XC LRM	767 135	54	PHE3 PK10 30 L SB ZK	767 932	31	RSI 34	785 214	123	SKS M12X25 V2A	561 925	170
MA SDS M12	723 199	153	PHE3 PK10 30 S SB ZK	767 931	31	RSI 35	785 215	123	SKS M12X30 V2A	561 930	170
MOMS LORE EUK	799 100	150	PHE3 PK6 20 L SB ZK	767 922	31	RSI 38	785 216	123	SKS M12X35 V2A	561 935	170
						RSI 45	785 217	123			

Type	Part No.	Page	Type	Part No.	Page	Type	Part No.	Page	Type	Part No.	Page
SKS M16X30 V2A	561 931	170	STT 180 20	766 039	164	UEK 25 FS	774 034	79	UK K25 FL30 SQL	773 251	81
SPG DCA IT LRM	767 122	52	SZ HH 1060	765 040	17	UEK 25 HG	774 234	79	VH SC APS	785 753	134
SPN 500PR	766 544	44	SZ HH 1250	765 041	17	UEK 25 SKN	774 434	79	VL HOEL 20 500	785 398	124
SPN 1000PR	766 548	44	SZ HH 1500	765 042	17	UEK 30 FS	774 130	79	VS 500 SPN II	766 542	44
SRH 1180 IS 650 MS	785 119	123	SZ HH W20 1070	765 050	17	UEK 30 HG	774 330	79	WBN 200 2,5M NS	785 646	128
SSC ASH NS	785 427	125	SZ HH W20 1250	765 051	17	UEK 30 SKN	774 530	79	ZK55 IS	771 230	109
SSK 36 STK 560	766 164	174	SZ HH W20 1500	765 052	17	UK 25 SK	773 034	72	ZK55 IS BL	771 231	109
SSK 36 STK 930SN7689	766 169	174	TFRS MS	785 950	122	UK 25 SQ	773 234	72	ZK85 BS	771 232	109
SSK M12	765 005	175	TG DCA	767 110	50	UK 25 SQL	773 236	74	ZK85 BS BL	771 233	109
SSK SQ	765 009	175	TRS MS	785 100	120	UK 30 SK	773 130	72			
STT 55 27 30	785 111	164	TRS MS V1	785 112	120	UK 30 SQ	773 330	72			
STT 110 15	769 509	164	TRS NS	785 502	119	UK 30 SQL	773 331	74			
STT 120 30 15	766 704	164				UK K25 FL30 HG	774 251	81			

Notes

This catalogue replaces the Main Catalogue Safety Equipment 2014/2015.

Since we do not plan systems or parts of systems, our product recommendations should be regarded as product information and for advisory purposes only. Our oral and written application proposals are based on experience and are specified to the best of our knowledge. We do not accept any liability in this respect. This particularly applies to the different conditions of use which are beyond our control. We recommend to check whether the respective DEHN product is suitable for the intended application. Application, use and processing of our products are beyond our control. Therefore, the product is completely subject to the user's responsibility.

Illustrations are not binding.

We accept no liability for misprints, modifications and errors.

*) GTIN (EAN-Code)

In this catalogue, you will find the GTIN (EAN code) next to the Part No. For reasons of clarity, only the individual GTIN part is specified. The country and DEHN + SÖHNE code (40 13364) must be put in front of this number.

Abbreviations

PG	Product Group
PU	Packing Unit
SU	Sales Unit (Piece, Meter, Kit or Pair)
pc(s)	Piece
m	Meter
Sa	Kit
Pa	Pair

Weight Weight per sales unit

Key Words

Product	Page	Product	Page	Product	Page
Accessories for NS and MS Cleaning Kits	123	Fastening Material	170	RST Rescue Rods	15
Adapters	168 / 180	Field Sensor	174	SCS Switching Sticks	14
Artificial Leather Bag	163	Fixed Arc Fault Protection System DEHNshort	135	Sheet Steel Case	161
ASP Non-Contact Voltage Detector Kit	37	Fixed Ball Points	59	Short-Circuiting Bar	99
Ball Head Cap	71, 74, 79	Fixed Earthing Points	62	Single-pole Earthing and Discharge Devices	157
Barriers and Accessories	155	Fixed Phase Points	65	Single-pole PHV I Phase Comparator	48
Batteries	171	FRS ZK MS Damp Cleaning Kit	121	Storage Devices	169
Canvas Bag	164	Hand Oilier for Switchgear Installations	124	SZ Fuse Tonges	16
Clamp for Railway Tracks with Tommy Bar	81	Handle / Extensions	179	Test Probes	167
Conductor Clamp	76	HSA 194 High-Voltage Indicator	39	Test Prods	172
Covering Material and Insulating Mats	127	HSA 205 High-Voltage Indicator	40	Test Unit for DEHNcap/P	50
DEHNcare® APG – Protective Gloves	130	Ice Removal Rod	20	TFRS MS Combined Cleaning Kit	122
DEHNcare® APJ, APT and APC – Protective Jackets, Protective Trousers and Protective Coats	131	Indicators / Indicators with Test Prod	173	TRS MS Dry Cleaning Kit	120
DEHNcare® APS – Stay healthy	134	Insulating Gloves	126	TRS NS Dry Cleaning Kit	119
DEHNcap/A Voltage Indicator	51	Insulating Elements	178	Two-pole PHV Phase Comparator	46
DEHNcap/IT Interface Test Unit	52	Insulating Protective Shutters	113	Two-pole SPN Voltage Detector	44
DEHNcap/P Voltage Indicator	50	Insulating Stick Kit for Cleaning the Wind-screens of Electric Locomotives	22	Universal Clamp	72, 75, 79, 81
DEHNcap/PC-LRM Phase Comparator	53	Insulating Stick with Crank Handle	21	Voltage Limiting Devices	151
DEHNcap HR-LRM Test Set	52	Insulating Sticks	176	Wireless Inspection Camera	18
DEHNcap Test Adapter / Measuring Impedance	54	IS Insulating Sticks	10	Work according to the Five Safety Rules	9
DEHN – Information	5	Kits for Railway Applications	92		
DEHN – International	4	Light Sensor Supports and Support Rails for DEHNarc	142		
EaS Configurator: Easy online Configuration	88	Lock-out Systems	23		
Earth Clamp for Overhead Contact Lines	76	MikroΩmeter LoRe EaS	150		
Earth Connecting Elements for Railway Applications	81	Mobile Arc Fault Protection System DEHNarc	139		
Earth Connecting Elements for Switchgear Installations and Overhead Lines	78	NH Fuse Handle with Sleeve	125		
Earth Connecting Plates	63	Notes	191		
Earth Spike	78	Operating Heads	174		
Earthing Handle for Low-Voltage Installations	112	Periodic Testing of Safety Devices at DEHN + SÖHNE	144		
Earthing Kit	77	Phase Screw Clamp	73-74		
Earthing Sticks for Railway Applications	86	Phase Connecting Elements for Overhead Lines	73		
Earthing Sticks for Overhead Lines	84	Phase Connecting Elements for Railway Applications	76		
Earthing Sticks for Switchgear Installations	82	Phase Connecting Elements for Switchgear Installations	71		
Earthing and Short-Circuiting Cables, unequipped	66	PHE Voltage Detector	34		
Earthing and Short-Circuiting Devices for Railway Applications	96	PHE Voltage Detector Kit	36		
Earthing and Short-Circuiting Devices for Crane Conductor Bars	108	PHE III Voltage Detector	28		
Earthing and Short-Circuiting Devices (partly insulated) for Low-Voltage Cable Distribution Cabinets	104	PHE III Voltage Detector Kit	32		
Earthing and Short-Circuiting Devices (fully insulated) for Low-Voltage Cable Distribution Cabinets	101	PHE III ZK Indicator with Test Prod	31		
Earthing and Short-Circuiting Device for Street Lighting Systems	110	PHE/G d.c. Voltage Detector	42		
Easy Choice – Storage Bags and Transport Cases	160	PHG II Voltage Detector	41		
Electrodes	166	Plastic Bag / Rucksack	164		
End Fittings	168	Plastic Case	161		
ESH U Safety Helmet for Electricians	133	Pneumatic Glove Tester	126		
Extensions	179	PPE – Personal Protective Equipment	125		

1. General, Scope

- 1.1 All deliveries and services in business dealings with entrepreneurs take place exclusively under our general terms of sale (hereinafter "terms of sale"). We oppose deviating regulations, especially conflicting terms of purchase of the customer, unless we expressly agreed to the validity in writing. Our terms of sale apply even if we complete unconditional delivery to the customer while knowing that the terms of sale of the customer are in conflict with our own.
- 1.2 Our terms of sale only apply to entrepreneurs within the meaning of section 310, paragraph 1 of the German Civil Code (BGB), to current business relationships and to all future transactions with the customer.

2. Offer and Order, Reservation of Right of Modification and Copyright

- 2.1 Except where expressly identified by us as binding, documents such as diagrams, drawings and measurements, in particular in print media and online on our website www.dehn-international.com, are only indicative.
- 2.2 Should our order confirmation contain reasonable expansions, limitations, or other modifications with respect to the order, then the customer's agreement is implied, if he/she does not immediately, at the latest however within 3 business days from receipt of the order confirmation, oppose it.
- 2.3 Any order placed in our web shop shall be regarded as an offer to conclude a sales contract. A sales contract only comes into existence if the customer receives a written order confirmation or the goods are delivered / services are rendered.
- 2.4 Our goods are only delivered in the packaging units indicated in the catalogues. If a different number of items is ordered, the amount and price of the next larger packaging unit is considered agreed upon.
- 2.5 We reserve the right to make technical modifications to our services, insofar as such modifications promote technical progress or are unavoidable based on other circumstances and are reasonable for the customer.
- 2.6 We reserve ownership and copyright rights to diagrams, drawings, calculations, and other documents; these may not be made available to third parties without our express written consent.

3. Prices, Value-Added Tax, Packaging Costs

- 3.1 Our prices are subject to change without notice.
- 3.2 Prices include, insofar as nothing else is arranged, customary packaging from our plant without value-added tax. On the day of invoicing, the legally identified VAT amount is to be reimbursed to us.
- 3.3 The cost of non-customary packaging, e.g., collective or seaworthy packaging, is invoiced separately. The customer bears the cost of the disposal or return of packaging.

4. Passing of Risk, Optional Insurance

The risk of accidental loss and deterioration passes to the customer upon dispatch to the customer from our warehouse or plant, even if carriage-paid delivery is agreed upon. At the request and expense of the customer, we will insure the delivery against breakage, damage to goods in transit and fire damage.

5. Payment Due Dates, Discounts, Right of Refusal, Default, Small Order Quantity Surcharge

- 5.1 Unless otherwise agreed, invoices are payable net 10 days. The customer shall pay the costs of payment. Discount amounts are deductible only if they have been agreed on with us and all accounts payable due have been paid.
- 5.2 If the customer is in default with his payments, interest on the outstanding amount shall be payable at the rate of 9% above the base interest rate. We reserve the right to prove and allege higher default damages. The right of early notice of default remains unchanged. If we are required to advance performance and, if after the execution of the contract, it becomes apparent that our claim, in particular for payment, may be jeopardised by the customer's inability to perform, we may refuse performance.
- 5.3 The customer cannot charge counter-claims against our due payment claims or exercise a right of retention, unless the customer is entitled to a claim recognised by declaratory judgement that is not contested by us and if, while exercising the right of retention, the counter-claim from the customer is based on the same contractual relationship.
- 5.4 Orders, with the exception of cash sales, for which the net amount (invoiced amount without shipping costs and value-added tax) is less than €75.00, a small order surcharge of €25.00 will be charged.

6. Retention of Title, Assignment, Release of Securities

- 6.1 Delivered goods remain our property until the payment of all open business claims up to the point of invoicing. The claims of the customer including value-added tax from the resale of reserved goods, i.e., from a work performance using our goods, should already be transferred to us in the amount of the open invoice. In the case that the reserved goods from the customer are sold together with other

goods that do not belong to us, whether it be without or after processing, or are delivered within the framework of a working contract, the assignment of the resulting claim of the reserve buyer is calculated in the amount of the value of the reserved goods.

- 6.2 Should the value of the granted securities exceed the claims by more than 10%, we are obliged to retransfer or release the securities upon request. We shall select the securities to be released.
- 6.3 Our goods may only be transferred within the framework of proper business activity. The customer is not allowed to pawn or transfer the ownership of goods that are still in our possession.
- 6.4 At our request, the customer is obliged to inform us of the purchaser and the arranged price and to show the assignment to its debtor.

7. Delivery Period and Date

- 7.1 The start of the delivery period presupposes the involvement of the customer for the clarification of all technical questions.
- 7.2 Delivery periods as well as delivery dates will be appropriately extended if they cannot be adhered to as a result of military mobilisation, war, uprising, strike or lockout, delayed delivery of raw and auxiliary materials, late delivery by our suppliers, or similar circumstances beyond our control. A lasting obstruction under these circumstances gives us the right to withdraw from the contract without liability for damages.

8. Liability for Material and Title Defects

- 8.1 We shall assume liability without restriction in compliance with the statutory regulations, provided that the customer asserts claims for damage compensation, which are attributable to wilful intent or gross negligence, including wilful intent and gross negligence on the part of our representatives or vicarious agents.
- 8.2 We shall assume liability without restriction in compliance with the statutory regulations, in case of culpable injury to life, limb or health; this shall also apply to the mandatory liability under the Product Liability Act.
- 8.3 In so far as a defect of the subject of the contract exists for which we are liable, we shall at our discretion either remedy the defect or deliver a non-defective object of the contract (subsequent performance).
- 8.4 If said subsequent performance should fail or if it is unreasonable for the customer, or if we refuse seriously and conclusively to do so or if we have delayed rectification unreasonably or if other circumstances prevail, which justify immediate withdrawal or damage compensation, taking account of the interests on both sides, then the customer shall be entitled to reduce the contract price or to withdraw from the contract and/or to demand damage compensation. In the event of only a slight infringement of contract, in particular in the event of only slight defects, the customer shall not be entitled to withdraw.
- 8.5 If the customer should choose only damage compensation after the failure of subsequent performance, then the subject of the contract shall remain with the customer, if this can be reasonably expected. Damage compensation shall be restricted – subject to item 8.1 and 8.2 – to the difference between the purchase price (without value added tax) and the value of the defective subject of the contract remaining with the purchaser.
- 8.6 Insofar as not otherwise specified above, liability shall be excluded.
- 8.7 The limitation period for claims based on defects, – subject to item 8.1 and 8.2 – shall be 12 months from delivery of the goods.
- 8.8 Items 8.1 to 8.7 shall not affect the rights of the customer, if we have fraudulently concealed a defect or have assumed a guarantee for quality.

9. Overall liability

- 9.1 Any further liability for compensation than that provided in item 8 – irrespective of the legal nature of the asserted claim – shall be excluded. This shall in particular apply to damage claims for liabilities resulting from culpa in contrahendo, for other breaches of duty or for tortious claims for damage compensation acc. to § 823 BGB (German code civil law).
- 9.2 Limitation according to 9.1 shall also apply, insofar as the customer claims reimbursement for useless expenditures instead of claiming compensation for damages in place of performance.
- 9.3 As far as the liability for compensation against us is excluded or restricted, this shall also apply with regard to the personal liability for damages of our employees, workers, representatives and vicarious agents.

10. Return of Goods without Legal Liability

- 10.1 If no legal claim to return exists, delivered goods will be accepted only with previous agreement from us. Returns without previous agreement will be send back – postage-

due – to the sender without inspection. The customer bears the shipping costs for the return delivery in No. 10.1.

- 10.2 The goods must still be in the original packaging. Special orders or deliveries dating back further than three months cannot be returned. In order to cover the costs of goods returns, a processing fee of 20% of the net value of the goods or €25.00, whichever is the greater, shall be applied, unless the customer can prove to us that we have incurred no or considerably smaller damage. If the goods can no longer be resold at the list price at the time of the return, an additional deduction (old goods deduction) will be made in addition to the processing fee. If we make an exception and agree to accept the return of parts that are unpackaged and that are no longer in their original packaging, an expense remuneration of at least 15% will be charged for reworking and repackaging in addition to the processing fee and, if applicable, the old goods deduction, unless the customer can prove to us that we have incurred no or considerably smaller damage.

- 10.3 Returned goods will only be credited to a new invoice. Credits cannot be used to clear invoices due at the time of the return.

11. Product Information, No Advisory Obligation

Our deliveries are intended only for speciality stores or skilled users. Our user information and instructions are limited to the details of each written product information (e.g., installation instructions, catalogues, data sheets). Further advisory obligations do not exist. Application, use, and processing of the products lie solely in the customer's realm of responsibility.

12. Additional Conditions for the Provision of Services

- 12.1 We make our offers without conducting a separate test to ascertain the suitability of the products for the relevant customer project. Our liability is excluded unless we were aware of anything contrary to suitability or we were not so aware due to gross negligence. The customer is responsible for conducting the requisite test.
- 12.2 We also make our offers on the basis of the specifications submitted by the customer without conducting a separate test to ascertain the suitability of the products on an individual basis. Our liability is excluded unless we were aware of anything contrary to suitability or we were not so aware due to gross negligence when checking the specifications. The customer is responsible for conducting the requisite test.
- 12.3 Our application proposals with product recommendations are of a general nature and are neither designed for application to an individual case nor intended to enable such application. Our application proposals are therefore non-binding. We do not accept any liability in this respect. It is absolutely essential to conduct an appropriate test on an individual basis. The customer is responsible for conducting such a test.
- 12.4 Our concept proposals with product recommendations do not replace the prevailing recognised engineering standards. The concept proposals with product recommendations do not claim to be exhaustive, unless expressly agreed otherwise. We do not plan systems or parts thereof. In particular, our concept proposals with product recommendations do not replace specific planning and testing. This lies in the customer's realm of responsibility. We do not accept any liability in this respect.
- 12.5 The sole purpose of the seminars we organise for the customer is to broaden his knowledge and to enable him to check his level of knowledge. We do not monitor and test the knowledge that the customer acquires and applies. We do not accept any liability in this respect. The seminars will always be kept up to date so that they meet the requirements of the recognised engineering standards.

13. Use and Protection of Customer Data

We use customer data, which concern the business dealings with the customer, in terms of the Federal Data Protection Act.

14. Applicable Law, Jurisdiction

- 14.1 German law applies to the mutual contractual obligations, their materialisation, interpretation, and implementation as well as all resulting contractual and business relationships. The application of the UN Agreement on Contracts on the International Purchase of Goods and the thereafter enacted laws of the Federal Republic of Germany is excluded.
- 14.2 Place of performance and jurisdiction for delivery, payment, and for all obligations, including those from exchange and cheque payments – if the customer is a businessperson, legal entity of public law or of special fund under public law – is exclusively Nuremberg.

15. VAT Identification Number

VAT ID No. DE 133251475

DEHN + SÖHNE GmbH + Co.KG.
Nürnberg – Neumarkt



Surge Protection
Lightning Protection
Safety Equipment
DEHN protects.

DEHN + SÖHNE
GmbH + Co.KG.

Hans-Dehn-Str. 1
Postfach 1640
92306 Neumarkt
Germany

Phone +49 9181 906-0
Fax +49 9181 906-1100
sales@dehn.de
www.dehn-international.com



www.dehn-international.com



Follow us on Facebook, LinkedIn,
YouTube, Google+, Xing.

Information on our registered trademarks in the internet at www.dehn-international.com/en/our-registered-trademarks.
Technical modifications, misprints, and errors are reserved. Figures are without obligation.